



# **Aviation Occurrence Report**

ASC-AOR-16-06-001

**4 February, 2015**

**TransAsia Airways Flight GE235**

**ATR72-212A**

**Loss of Control and Crashed into Keelung River  
Three Nautical Miles East of Songshan Airport**



# Aviation Occurrence Report

ASC-AOR-16-06-001

4 February, 2015

TransAsia Airways Flight GE235

ATR72-212A

Loss of Control and Crashed into Keelung River

Three Nautical Miles East of Songshan Airport

Aviation Occurrence Report: 4 February, 2015, TransAsia Airways Flight GE235  
ATR72-212A, Loss of Control and Crashed into Keelung River Three Nautical Miles  
East of Songshan Airport

Edited and published by Aviation Safety Council

11F, No.200, Sec.3, Beisin Rd., Sindian City.

Taipei County 231, Taiwan, R.O.C.

Tel: +886-2-8912-7388

Fax: +886-2-8912-7399

<http://www.asc.gov.tw>

GPN : 4910501705

ISBN : 9789860497175

First printing, July, 2016

Copyright 2016 by Aviation Safety Council

**According to the Aviation Occurrence Investigation Act of the Republic of China and the International Civil Aviation Organization (ICAO) Annex 13, this report is only for the improvements of flight safety.**

**Aviation Occurrence Investigation Act of the Republic of China, Article 5 :**

*The objective of the ASC's investigation of aviation occurrence is to prevent recurrence of similar occurrences. It is not the purpose of such investigation to apportion blame or liability.*

**ICAO Annex 13, Chapter 3, Section 3.1 :**

*The sole objective of the investigation of an accident or incident shall be the prevention of accidents and incidents. It is not the purpose of this activity to apportion blame or liability.*

**This report is written in both Chinese and English.**

Intentionally left blank

## Executive Summary

On February 4, 2015, about 1054 Taipei Local Time, TransAsia Airways (TNA) flight GE 235, an ATR-GIE Avions de Transport Régional ATR72-212A (ATR72-600) aircraft, registered B-22816, experienced a loss of control during initial climb and impacted Keelung River, three nautical miles east from its departing runway 10 of Taipei's Songshan Airport. Forty-three occupants were fatally injured, including three flight crew, one cabin crew, and 39 passengers. The remaining 13 passengers and one cabin crew sustained serious injuries. One passenger received minor injuries. The aircraft was destroyed by impact forces. The aircraft's left wing tip collided with a taxi on an overpass before the aircraft entered the river. The taxi driver sustained serious injuries and the only taxi passenger sustained minor injuries. Flight 235 was on an instrument flight rules (IFR) regular public transport service from Songshan to Kinmen.

The accident was the result of many contributing factors which culminated in a stall-induced loss of control. During the initial climb after takeoff, an intermittent discontinuity in engine number 2's auto feather unit (AFU) may have caused the automatic takeoff power control system (ATPCS) sequence which resulted in the uncommanded autofeather of engine number 2 propellers. Following the uncommanded autofeather of engine number 2 propellers, the flight crew did not perform the documented abnormal and emergency procedures to identify the failure and implement the required corrective actions. This led the pilot flying (PF) to retard power of the operative engine number 1 and shut down it ultimately. The loss of thrust during the initial climb and inappropriate flight control inputs by the PF generated a series of stall warnings, including activation of the stick shaker and pusher. After the engine number 1 was shut down, the loss of power from both engines was not detected and corrected by the crew in time to restart engine number 1. The crew did not respond

to the stall warnings in a timely and effective manner. The aircraft stalled and continued descent during the attempted engine restart. The remaining altitude and time to impact were not enough to successfully restart the engine and recover the aircraft.

Had the crew prioritized their actions to stabilize the aircraft flight path, correctly identify the propulsion system malfunction which was the engine number 2 loss of thrust and then take actions in accordance with procedure of engine number 2 flame out at take off, the occurrence could have been prevented. The investigation report identified a range of contributing and other safety factors relating to the engine's auto feather unit, crew of the aircraft, TransAsia's flight operations and management processes, and the regulatory oversight of TransAsia by the Civil Aeronautics Administration (CAA).

This investigation identified important learning opportunities for pilots, operators, regulatory agencies and aircraft manufacturer to improve future aviation safety and to seek to ensure such an accident never happens again. The Aviation Safety Council (ASC) has issued a series of safety recommendations to TransAsia Airways, CAA and aircraft/engine/component manufacturers to correct the serious safety deficiencies identified during the investigation. The manufacturers of aircraft, engine and auto feather unit have also implemented various safety actions in response to the occurrence.

According to Article 6 of the Republic of China (ROC) Aviation Occurrence Investigation Act, and the content of Annex 13 to the Convention on International Civil Aviation, the ASC, an independent aviation occurrence investigation agency, was responsible for conducting the investigation. The investigation team also included members from BEA (Bureau d'Enquêtes et d'Analyses, France), TSB (Transportation Safety Board, Canada), NTSB (National Transportation Safety Board, USA), ATR (Avions de Transport Régional), P&WC (Pratt & Whitney Canada), UTAS (United Technologies Aerospace Systems)/USA, CAA Taiwan, and TNA.

The 'Draft Final Report' of the occurrence investigation was completed in January

2016. In accordance with the procedures, it was reviewed at ASC's 41th Council Meeting on January 26<sup>th</sup>, 2016 and then sent to relevant organizations and authorities for comments. After comments were collected and integrated, the English version Final Report was reviewed and approved by ASC's 44<sup>th</sup> Council Meeting on 26 April 2016. The Chinese version Final Report was reviewed and approved by ASC's 45<sup>th</sup> Council Meeting on 31 May 2016. Both versions of Final Report were published on 30 June 2016.

There are a total of 25 findings from the draft Final Report, and 16 safety recommendations issued to the related organizations.

### **Findings as the result of this investigation**

The ASC presents the findings derived from the factual information gathered during the investigation and the analysis of the occurrence. The findings are presented in three categories: **findings related to probable causes**, **findings related to risk**, and **other findings**.

The **findings related to probable causes** identify elements that have been shown to have operated in the occurrence, or almost certainly operated in the occurrence. These findings are associated with unsafe acts, unsafe conditions, or safety deficiencies associated with safety significant events that played a major role in the circumstances leading to the occurrence.

The **findings related to risk** identify elements of risk that have the potential to degrade aviation safety. Some of the findings in this category identify unsafe acts, unsafe conditions, and safety deficiencies including organizational and systemic risks, that made this occurrence more likely; however, they cannot be clearly shown to have operated in the occurrence alone. Furthermore, some of the findings in this category identify risks that are unlikely to be related to the occurrence but, nonetheless, were safety deficiencies that may warrant future safety actions.

**Other findings** identify elements that have the potential to enhance aviation



safety, resolve a controversial issue, or clarify an ambiguity point which remains to be resolved. Some of these findings are of general interests that are often included in the ICAO format accident reports for informational, safety awareness, education, and improvement purposes.

## **Findings Related to Probable Causes**

### **Powerplant**

1. An intermittent signal discontinuity between the auto feather unit (AFU) number 2 and the torque sensor may have caused the automatic take off power control system (ATPCS):
  - Not being armed steadily during takeoff roll;
  - Being activated during initial climb which resulted in a complete ATPCS sequence including the engine number 2 autofeathering.
2. The available evidence indicated the intermittent discontinuity between torque sensor and auto feather unit (AFU) number 2 was probably caused by the compromised soldering joints inside the AFU number 2.

### **Flight Operations**

3. The flight crew did not reject the take off when the automatic take off power control system ARM pushbutton did not light during the initial stages of the takeoff roll.
4. TransAsia Airways did not have a clear documented company policy with associated instructions, procedures, and notices to crew for ATR72-600 operations communicating the requirement to reject the take off if the automatic take off power control system did not arm.
5. Following the uncommanded autofeather of engine number 2, the flight crew failed to perform the documented failure identification procedure before executing any actions. That resulted in pilot flying's confusion regarding the identification and nature of the actual propulsion system malfunction and he reduced power on the

- operative engine number 1.
6. The flight crew's non-compliance with TransAsia Airways ATR72-600 standard operating procedures - Abnormal and Emergency Procedures for an engine flame out at take off resulted in the pilot flying reducing power on and then shutting down the wrong engine.
  7. The loss of engine power during the initial climb and inappropriate flight control inputs by the pilot flying generated a series of stall warnings, including activation of the stick pusher. The crew did not respond to the stall warnings in a timely and effective manner.
  8. The loss of power from both engines was not detected and corrected by the crew in time to restart an engine. The aircraft stalled during the attempted restart at an altitude from which the aircraft could not recover from loss of control.
  9. Flight crew coordination, communication, and threat and error management (TEM) were less than effective, and compromised the safety of the flight. Both operating crew members failed to obtain relevant data from each other regarding the status of both engines at different points in the occurrence sequence. The pilot flying did not appropriately respond to or integrate input from the pilot monitoring.

## **Findings Related to Risk**

### **Powerplant**

1. The engine manufacturer attempted to control intermittent continuity failures of the auto feather unit (AFU) by introducing a recommended inspection service bulletin at 12,000 flight hours to address aging issues. The two AFU failures at 1,624 flight hours and 1,206 flight hours show that causes of intermittent continuity failures of the AFU were not only related to aging but also to other previously undiscovered issues and that the inspection service bulletin implemented by the engine manufacturer to address this issue before the occurrence was not sufficiently effective. The engine manufacturer has issued a modification addressing the specific

finding of this investigation. This new modification is currently implemented in all new production engines, and another service bulletin is available for retrofit.

### **Flight Operations**

2. Pilot flying's decision to disconnect the autopilot shortly after the first master warning increased the pilot flying's subsequent workload and reduced his capacity to assess and cope with the emergency situation.
3. The omission of the required pre-take off briefing meant that the crew were not as mentally prepared as they could have been for the propulsion system malfunction they encountered after takeoff.

### **Airline Safety Management**

4. TransAsia Airways (TNA) did not follow its own procedures when selecting and training pilot flying for upgrade. The TNA's quality assurance processes had not detected that the command selection upgrade process had been compromised.
5. TransAsia Airways (TNA) did not use widely available crew resource management (CRM) guidelines to develop, implement, reinforce, and assess the effectiveness of their flight crew CRM training program.
6. While the TransAsia Airways (TNA) ATR72-600 differences training program was consistent with the European Aviation Safety Agency ATR72 operational evaluation board report and compliant from a Civil Aeronautics Administration regulatory perspective, it may not have been sufficient to ensure that TNA flight crews were competent to operate the ATR72-600 under all normal procedures and a set of abnormal conditions.
7. The ATR72-600 differences training records for the GE 235 flight crew showed that Captain A probably needed more training on the single engine flame out at take off procedure. That meant if the differences training records were stored, adequately maintained and evaluated by appropriate TransAsia Airways (TNA) flight operations

and/or quality assurance personnel, the TNA would have had yet another opportunity to review Captain A's ability to handle engine out emergencies.

8. Captain A's performance during the occurrence was consistent with his performance weaknesses noted during his training, including his continued difficulties in handling emergency and/or abnormal situations, including engine flame out at take off and single engine operations. However, TransAsia Airways did not effectively address the evident and imminent flight safety risk that Captain A presented.

### **Regulatory Oversight**

9. The Civil Aeronautics Administration's (CAA) oversight of flight crew training, including crew resource management (CRM) training, is in need of improvement.
10. The systemic TransAsia Airways (TNA) flight crew non-compliances with standard operating procedures identified in previous investigations, including GE 222, remained unaddressed at the time of the GE235 occurrence. Although the Civil Aeronautics Administration (CAA) had conducted a special audit after the GE 222 accident which identified the standard operating procedures compliance issue, the CAA did not ensure that TNA responded to previously identified systemic safety issues in a timely manner to minimize the potential risk.

### **Other Findings**

1. The flight crew were certificated and qualified in accordance with Civil Aeronautics Administration (CAA) regulations and company requirements. There was no evidence to indicate that the flight crew's performance might have been adversely affected by pre-existing medical conditions, fatigue, medication, other drugs or alcohol during the occurrence flight.
2. Visual meteorological conditions (VMC) prevailed at the time of the aircraft's departure. No adverse weather conditions were present for the flight.
3. The aircraft's certificate of airworthiness and registration were current at the time of the occurrence. The occurrence aircraft was dispatched at Songshan Airport with no

known defects and was in compliance with all applicable airworthiness directives and service bulletins. A review of the aircraft's maintenance records before the occurrence flight revealed that there were no defects reported that related to engine number 2 automatic feathering system.

4. Flight crew transferred from conventional flight instruments to a more advanced avionic suite with primary flight display, the visual pattern and information picked up by the crew in an emergency situation may not be retrieved at the same location with the same display.
5. Although the influence of the flight director indication was not demonstrated in the occurrence flight and the logics of ATR flight director bars are consistent with other aircraft types within the industry, the simulator flight illustrated the flight director bars indication during stall warning were in contradiction with the automatic stall protection inputs and thus may disturb the crew.
6. The ATR72 formal document has no general statement of rejecting take off policy and procedure of rejecting take off with both engines operative.

## **Safety Recommendations**

### **To TransAsia Airways**

1. Document a clear company policy with associated instructions, procedures, training, and notices to crew members for ATR72-600 operations communicating the requirement to reject a takeoff in the event that the automatic take off power control system (ATPCS) is not armed as required. (ASC-ASR-16-06-001)
2. Conduct a thorough review of the airline's flight crew training programs, including recurrent training, crew resource management (CRM) training, upgrade training, differences training, and devise systematic measures to ensure that
  - Standardized flight crew check and training are conducted;
  - All flight crews comply with standard operating procedures;
  - All flight crews are proficient in handling abnormal and emergency procedures,

including engine flame out at takeoff;

- The airlines use widely available guidelines to develop, implement, reinforce, and assess the effectiveness of their flight crew resource management (CRM) training program, particularly the practical application of those skills in handling emergencies;
- Command upgrade process and training comply with the airline's procedures and that competent candidates are selected;
- ATR72-600 differences training and subsequent line training are sufficient to ensure that flight crews are competent to operate the ATR72-600 under all normal and abnormal conditions; and
- All flight crew training records during the employment period are retained in compliance with the aircraft flight operation regulations.

(ASC-ASR-16-06-002)

3. Improve the airline's internal quality assurance oversight and audit processes to ensure that recurring safety, training, and administrative problems are identified and rectified in a timely manner. (ASC-ASR-16-06-003)
4. Implement and document an effective and formal pilot performance review program to identify and manage pilots whose performance is marginal. (ASC-ASR-16-06-004)
5. Evaluate the safety culture of the airline to develop an understanding of the reasons for the airline's unacceptable safety performance, especially the recurring noncompliance with procedures. (ASC-ASR-16-06-005)

### **To Civil Aeronautics Administration**

1. Review airline safety oversight measures to ensure that safety deficiencies are identified and addressed in an effective and timely manner. (ASC-ASR-16-06-006)
2. Implement a highly robust regulatory oversight process to ensure that airline safety improvements, in response to investigations, audits, or inspections, are implemented

in a timely and effective manner. (ASC-ASR-16-06-007)

3. Conduct a detailed review of the regulatory oversight of TransAsia Airways to identify and ensure that the known operational safety deficiencies, including crew noncompliance with procedures, nonstandard training practices, and unsatisfactory safety management, were addressed effectively. (ASC-ASR-16-06-008)
4. Provide inspectors with detailed guidance on how to evaluate the effectiveness of operator nontechnical training programs such as crew resource management (CRM) and threat and error management (TEM) training programs. (ASC-ASR-16-06-009)

#### **To UTC Aerospace System Company**

1. Work with the manufacturers of engine and aircraft to assess the current operating parameters and aircraft risks associated with the PW127 series engine auto feather unit (AFU) to minimize or prevent occurrences that could result in uncommanded autofeather. (ASC-ASR-16-06-010)

#### **To Pratt & Whitney Canada**

1. Work with manufacturers of the auto feather unit (AFU) and aircraft to assess the current operating parameters and aircraft risks associated with the PW127 series engine auto feather unit to minimize or prevent occurrences that could result in uncommanded autofeather. (ASC-ASR-16-06-011)

#### **To Avions de Transport Régional**

1. Work with manufacturers of the auto feather unit and engine to assess the current operating parameters and aircraft risks associated with the PW127 series engine auto feather unit (AFU) to minimize or prevent occurrences that could result in uncommanded autofeather. (ASC-ASR-16-06-012)
2. Publish in the flight crew operating manual (FCOM) an operational procedure related to rejected take off and expanded information regarding conditions leading to rejected take off. (ASC-ASR-16-06-013)

**To European Aviation Safety Agency**

1. Require a review at industry level of manufacturer's functional or display logic of the flight director so that it disappears or presents appropriate orders when a stall protection is automatically triggered. (ASC-ASR-16-06-014)
2. Study the content and the duration of the minimum requirement regarding a differences training program between a conventional avionics cockpit and an advanced suite including enhanced automated modes for aircraft having the same type rating. (ASC-ASR-16-06-015)
3. Require a review of manufacturer's airplane flight manual (AFM) to ensure that a rejected take off procedure is also applicable to both engines operating. (ASC-ASR-16-06-016)



Intentionally left blank

---

# Contents

Executive Summary .....	I
Contents.....	XIII
Tables .....	XXI
Figures.....	XXIII
Abbreviation.....	XXV
<b>Chapter 1 Factual Information.....</b>	<b>1</b>
1.1 History of Flight.....	1
1.2 Injuries to Persons.....	6
1.3 Damage to Aircraft.....	7
1.4 Other Damage .....	7
1.5 Personnel Information.....	7
1.5.1 Flight Crew Background and Experience .....	7
1.5.1.1 Captain A.....	7
1.5.1.2 Captain B.....	8
1.5.1.3 First Officer.....	8
1.5.2 Flight Crew Training Record .....	10
1.5.2.1 Captain A.....	10
1.5.2.2 Captain B.....	13
1.5.2.3 First Officer.....	15
1.5.3 Flight Crew Medical Information .....	16
1.5.3.1 Captain A.....	16
1.5.3.2 Captain B.....	16
1.5.3.3 First Officer.....	16
1.5.4 Flight Crew Activities within 72 Hours before the Occurrence .....	16
1.5.4.1 Captain A.....	16
1.5.4.2 Captain B.....	17

1.5.4.3	First Officer .....	17
1.6	Aircraft Information .....	17
1.6.1	Aircraft and Engine Basic Information .....	17
1.6.2	Aircraft Maintenance Records .....	18
1.6.3	Propeller Systems .....	19
1.6.4	Automatic Take off Power Control System .....	20
1.6.5	Engine Torque Sensing and Indication.....	24
1.6.6	Weight and Balance Information.....	25
1.7	Weather Information.....	26
1.8	Aids to Navigation .....	27
1.9	Communication .....	27
1.9.1	Communication within the Passenger Cabin .....	27
1.10	Aerodrome.....	28
1.11	Flight Recorders .....	29
1.11.1	Cockpit Voice Recorder.....	29
1.11.2	Flight Data Recorder .....	31
1.11.3	Other Flight Data and Radar Track Data.....	32
1.11.3.1	Quick Access Recorder Data.....	32
1.11.3.2	Secondary Surveillance Radar Data.....	32
1.11.4	Flight Path Reconstruction.....	32
1.12	Wreckage and Impact Information.....	37
1.12.1	Recovery of Aircraft Wreckage.....	38
1.12.2	Wreckage Transfer and Storage .....	41
1.12.3	Video Footage and Impact Information .....	41
1.12.3.1	Video Footage of the Occurrence.....	44
1.13	Medical and Pathological Information.....	46
1.13.1	Medical Treatment of Surviving Passengers.....	46
1.13.2	Flight Crew Toxicology Information .....	47

---

1.13.3	Flight Crew Autopsies.....	47
1.13.4	Victim Inspections.....	47
1.14	Fire .....	48
1.15	Survival Aspects.....	48
1.15.1	Emergency Escape .....	48
1.15.2	Rescue .....	49
1.16	Tests and Research .....	50
1.16.1	TNA Simulator Training Observation.....	50
1.16.2	Simulation Testing .....	50
1.16.3	Aircraft Structure Examination .....	54
1.16.4	Engine Examination .....	54
1.16.4.1	Engine Number 1 .....	55
1.16.4.2	Engine Number 2 .....	55
1.16.5	Components Test and Examination.....	57
1.16.5.1	Auto Feather Units Testing .....	57
1.16.5.2	MFCs NVM Data Download .....	66
1.16.5.3	PECs and EECs Data Download.....	68
1.16.5.4	Wiring Harnesses .....	69
1.16.5.5	Engine Sensors.....	71
1.17	Organizational and Management Information .....	75
1.17.1	Flight Operations Division.....	75
1.17.1.1	Initial ATR72 Training .....	77
1.17.1.2	Recurrent Training .....	78
1.17.2	First Officer to Captain Upgrade Process and Training.....	78
1.17.2.1	Captain Upgrade Selection Process .....	78
1.17.2.2	Upgrade Ground Training .....	79
1.17.3	ATR72-500 to ATR72-600 Differences Training.....	80
1.17.3.1	EASA Operational Evaluation Board Report .....	80

1.17.3.2	TNA ATR72-600 Differences Training Program .....	81
1.17.4	Crew Resources Management Training .....	81
1.17.4.1	Training Policy .....	82
1.17.4.2	CRM and Human Factors Ground Course Material .....	84
1.17.5	Training Records Management .....	84
1.17.6	ATPCS Check Associated Policy and Procedures .....	84
1.17.7	Civil Aeronautics Administration Regulatory Safety Surveillance / Inspection Program .....	88
1.18	Additional Information.....	90
1.18.1	Factors Affecting Flight with One Engine Inoperative .....	90
1.18.1.1	Critical Speeds for a Powerplant Malfunction or Shutdown after Take off.....	90
1.18.2	Manual Information .....	92
1.18.2.1	Flight Operations Manual .....	92
1.18.2.2	TNA Standard Operating Procedure .....	99
1.18.2.3	ATR72-600 Flight Crew Operations Manual.....	109
1.18.2.4	ATR Flight Crew Training Manual .....	114
1.18.2.5	ATR72-600 Minimum Equipment List and Configuration Difference List .....	117
1.18.2.6	Songshan Airport Departure Aeronautical Chart .....	117
1.18.3	Interview Summaries .....	119
1.18.3.1	TNA Flight Crew Interviews.....	119
1.18.3.2	Maintenance Division Assistant Manager.....	122
1.18.3.3	Maintenance Personnel Stationed at Kinmen Airport...	123
1.18.3.4	Maintenance Personnel Stationed at Songshan Airport	124
1.18.3.5	Songshan Tower Local Controller.....	125
1.18.3.6	Songshan Tower Supervisor.....	126
1.18.4	Abnormal Engine Torque Related Events/Information.....	127

---

1.18.4.1	Chronology of TNA ATR72 Abnormal Engine Torque Related Events/Information .....	127
1.18.4.2	Related Service Information Issued by P&WC .....	128
1.18.4.3	Emergency Airworthiness Directive .....	129
1.18.5	Propulsion System Malfunction and Inappropriate Crew Response .....	130
1.18.5.1	Overview of PSM+ICR Study .....	130
1.18.5.2	Turboprop Aircraft .....	132
1.18.5.3	Failure Cues .....	132
1.18.5.4	Effect of Autofeather Systems .....	133
1.18.5.5	Training Issues .....	134
1.18.5.6	Training Recommendations .....	136
1.18.5.7	Error types .....	136
1.18.6	U.S. Army 'Wrong Engine' Shutdown Study .....	138
1.18.7	Additional Human Factors considerations .....	139
1.18.7.1	Diagnostic skills .....	139
1.18.7.2	Situational Awareness .....	140
1.18.7.3	Stress .....	145
<b>Chapter 2</b>	<b>Analysis .....</b>	<b>147</b>
2.1	General .....	147
2.2	Airworthiness .....	147
2.2.1	Aircraft Systems and Powerplant .....	147
2.2.2	ATPCS and Uncommanded Autofeather .....	148
2.2.3	Autofeather Unit Quality .....	150
2.3	Flight Operations .....	151
2.3.1	ATPCS Policy and Procedures .....	151
2.3.2	ATR Rejected Take off Policy .....	153
2.3.3	Handling of Emergency Situation .....	154

2.3.3.1	Failure Identification.....	154
2.3.3.2	Utilization of Autopilot .....	156
2.3.4	Non-Compliance with Procedures .....	157
2.3.5	Aircraft Recovery.....	160
2.3.6	Human Factors Perspectives of Flight Crew Performance .....	161
2.3.6.1	Flight Crew Performance .....	161
2.3.6.2	Diagnostic Errors .....	162
2.3.6.3	Stress and Mental Preparation.....	162
2.3.6.4	Flight Crew Training and Competency Issues .....	164
2.3.6.5	Command Upgrade Process .....	166
2.3.6.6	Crew Resource Management and Crew Coordination..	167
2.3.6.7	TNA Crew Resource Management Training.....	170
2.3.6.8	Negative Transfer .....	171
2.3.7	ATR72 Differences Training Program and TNA Records Management.....	172
2.3.7.1	Training Program .....	172
2.3.7.2	Records Management.....	173
2.4	CAA Oversight.....	174
<b>Chapter 3</b>	<b>Conclusions .....</b>	<b>175</b>
3.1	Findings Related to Probable Causes.....	175
3.2	Findings Related to Risk .....	177
3.3	Other Findings.....	179
<b>Chapter 4</b>	<b>Safety Recommendations .....</b>	<b>181</b>
4.1	Recommendations .....	181
4.2	Safety Actions Accomplished .....	184
4.2.1	TransAsia Airways .....	184
4.2.2	Civil Aeronautics Administration.....	188
4.2.3	Avions de Transport Regional.....	190

---

Appendix 1	The ATC Radio and Hotline Communication Transcript.....	193
Appendix 2	GE 235 CVR Transcript .....	199
Appendix 3	FDR Data Plots.....	221
Appendix 4	Engine Sensors Test Summary .....	225
Appendix 5	TNA ATR72-600 Difference Training Syllabus.....	227
Appendix 6	AFM Supplement 7_02.10 .....	229
Appendix 7	TNA ATR72-600 Normal Checklist.....	231
Appendix 8	SOP Policy Regarding the Checks Performed During Take Off and Focus on ATPCS Check .....	233
Appendix 9	MEL Paragraph Related to Propellers.....	241
Appendix 10	P&WC Service Bulletin No.21742R1 .....	245
Appendix 11	CAA AD No.CAA-2015-02-013E Revised.....	253
Appendix 12	ATR OEB on Uncommanded Auto-feather.....	257
Appendix 13	P&WC Service Bulletin No. 21880R1 .....	259
Appendix 14	Analysis of Autopilot Disengagement with FDR Data .....	271
Appendix 15	Comments on ASC's Draft Final Report .....	277
Appendix 15-1	Comments on ASC's Draft Final Report from BEA .....	278
Appendix 15-2	Comments on ASC's Draft Final Report from TSB.....	279
Appendix 15-3	Comments on ASC's Draft Final Report from NTSB.....	280
Appendix 15-4	Comments on ASC's Draft Final Report from CAA Taiwan .....	281
Appendix 15-5	Comments on ASC's Draft Final Report from TransAsia Airways .....	296



Intentionally left blank

---

## Tables

Table 1.2-1	Injury table .....	7
Table 1.5-1	Flight crew basic information .....	9
Table 1.6-1	Aircraft basic information .....	18
Table 1.6-2	Engine basic information .....	18
Table 1.6-3	Weight and balance data.....	26
Table 1.11-1	GE235 CVR/FDR Sequence of Events.....	35
Table 1.16-1	Continuity check of AFU No. 2 electrical circuit .....	56
Table 1.16-2	AFUs basic information .....	58
Table 1.16-3	AFU No. 2 J2 connector pins J and H resistance test results.....	61
Table 1.16-4	AFU No. 3 J2 connector pin J resistance test results .....	65
Table 1.16-5	Basic EEC and PEC information .....	69
Table 1.18-1	TNA ATR72 abnormal engine torque related events .....	127
Table 1.18-2	Factors involved in loss of situational awareness .....	143
Table 2.1-1	FDR data related to ATPCS .....	149

Intentionally left blank

## Figures

Figure 1.1-1	GE235 main wreckage .....	1
Figure 1.1-2	GE235 loss of control and initial impact sequence.....	6
Figure 1.6-1	PWR MGT selector and ATPCS pushbutton .....	21
Figure 1.6-2	Functions of the ATPCS.....	21
Figure 1.6-3	The ATPCS sequence after trigger.....	22
Figure 1.6-4	Simulated EWD indications for ENG 2 autofeather at take off.....	23
Figure 1.6-5	Simulated EWD indications for ENG 2 flame out at take off .....	24
Figure 1.6-6	Engine torque sensing and indication .....	25
Figure 1.6-7	ATR72-600 CG envelope.....	26
Figure 1.11-1	External view of the FDR and CVR .....	29
Figure 1.11-2	CVR CSMU connection to chassis .....	30
Figure 1.11-3	FDR CSMU connection to chassis.....	31
Figure 1.11-4	GE235 ATC radar track.....	32
Figure 1.11-5	Superimposed GE235 GPS flight path, ATC radar track and key cockpit warnings .....	33
Figure 1.11-6	GE235 flight path and key events rendered on a fused satellite image and digital surface model between 1053:07.7 and 1053:59.7.....	34
Figure 1.11-7	GE235 flight path and key events rendered on a fused satellite image and digital surface model for the final 23 seconds of flight .....	34
Figure 1.12-1	Wreckage recovery operations .....	38
Figure 1.12-2	Recovered aircraft wreckages (1) .....	39
Figure 1.12-3	Recovered aircraft wreckages (2) .....	40
Figure 1.12-4	Wreckage storage site.....	41
Figure 1.12-5	Aerial Photo of the GE235 crash site.....	42
Figure 1.12-6	Aircraft’s final trajectory and impact location .....	43
Figure 1.12-7	Aerial photo of occurrence site taken from a rescue helicopter.....	43

Figure 1.12-8	Snapshots extracted from the motor vehicle’s dashboard camera ....	45
Figure 1.12-9	14th frame of dashboard camera video .....	45
Figure 1.12-10	17th frame of dashboard camera video .....	46
Figure 1.12-11	19th frame of dashboard camera video .....	46
Figure 1.15-1	Injury and fatality distribution .....	48
Figure 1.16-1	PFD display while the stick pusher activated .....	54
Figure 1.16-2	Continuity check of AFU No. 2 electrical circuit .....	56
Figure 1.16-3	Continuity check of pin J and A2 board.....	60
Figure 1.16-4	Microscope (40X magnification) and SEM images for Pins 33 and 34. .....	62
Figure 1.16-5	Cross sectioned pin to flex solder joints of pins 33 .....	63
Figure 1.16-6	Cross sectioned pin to flex solder joints of pins 34 .....	63
Figure 1.16-7	Connectors of AFU (left) and torque sensor (right).....	69
Figure 1.16-8	X-ray examination of AFU and torque sensor connectors.....	70
Figure 1.16-9	Connector pins H (left) and J (right) of AFU No. 2.....	71
Figure 1.16-10	External view of ENG 2 torque sensor left S/N CH1468 .....	73
Figure 1.16-11	3D X-ray view of ENG 2 torque sensor left S/N CH1468.....	74
Figure 1.16-12	External view of ENG 2 torque sensor right S/N CH1457.....	75
Figure 1.17-1	TNA Flight Operations Division Organization chart.....	76
Figure 1.18-1	RCSS MUCHA TWO departure chart .....	118

## Abbreviation

AC	Advisory Circular
AD	Airworthiness Directive
AFCS	Automatic Flight Control System
AFM	Airplane Flight Manual
AFU	Auto Feather Unit
AIK	Accident Investigator's Kit
AIP	Aeronautical Information Publication
AMM	Airplane Maintenance Manual
ASC	Aviation Safety Council
ATC	Air Traffic Control
ATPCS	Automatic Take off Power Control System
ATR	Avions de Transport Régional
AP	Autopilot
ATPL	Air Transport Pilot License
BEA	Bureau d'Enquêtes et d'Analyses pour la sécurité de l'aviation civile (French aviation safety investigation agency)
CAA	Civil Aeronautics Administration
CAC	Core Avionic Cabinet
CAM	Cockpit Area Microphone
CAMP	Continuous Airworthiness Maintenance Program
CCA	Circuit Card Assembly
CDL	Configuration Difference List
CFIT	Controlled Flight Into Terrain
CG	Center of Gravity
CMM	Component Maintenance Manual
CP	Check Pilot
CRM	Crew Resource Management

CSMU	Crash Survival Memory Unit
CVR	Cockpit Voice Recorder
DCU	Data Collection Unit
DD	Deferred Defect
DE	Designated Examiner
DU	Display Unit
EASA	European Aviation Safety Agency
EEC	Engine Electronic Control
EGPWS	Enhanced Ground Proximity Warning System
EOSID	Engine Out Standard Instrument Departure
ETOPS	Extended Range Twin-Engine Operations
EWD	Engine Warning Display
FAA	Federal Aviation Administration
FCC	Flight Control Center
FCOM	Flight Crew Operations Manual
FD	Flight Director
FDR	Flight Data Recorder
FFS	Full Flight Simulator
FMS	Flight Management System
FO	First Officer
FOD	Flight Operations Division
FODOM	Flight Operations Department Operations Manual
FOM	Flight Operations Manual
FOQA	Flight Operations Quality Assurance
FTMM	Flight Training Management Manual
IAS	Indicated Air Speed
ICAO	International Civil Aviation Organization
IFR	Instrument Flight Rules
IOE	Initial Operating Experience

IP	Instructor Pilot
LNAV	Lateral Navigation
LOFT	Line Oriented Flight Training
LVO	Low Visibility Operations
MAC	Mean Aerodynamic Chord
MCC	Maintenance Control Center
MEL	Minimum Equipment List
METAR	Aerodrome Routine Meteorological Report
MFC	Multi Functional Computer
MPC	Multi Purpose Computer
MND	Ministry of National Defense
NM	Nautical Miles
NTSB	U.S. National Transportation Safety Board
NVM	Non-Volatile Memory
OBS	Observer
OEB	Operational Evaluation Board
PBN	Performance Based Navigation
PC	Proficiency Check
PEC	Propeller Electronic Control
PF	Pilot Flying
PFD	Primary Flight Display
PIC	Pilot In-Command
PLA	Power Lever Angle
PM	Pilot Monitoring
PMI	Principal Maintenance Inspector
PT	Proficiency Training
PVM	Propeller Valve Module
PWC	Pratt & Whitney Canada
QAR	Quick Access Recorder



QCC	Quality Control Center
RAM	Runway Analysis Manual
RCB	Reliability Control Board
RTOW	Regulated Take Off Weight
RVSM	Reduced Vertical Separation Minimum
SAFB	Songshan Air Force Base
SB	Service Bulletin
SDR	Service Difficulty Report
SEM	Scanning Electron Microscope
SID	Standard Instrument Departure
SIL	Service Information Letter
SOP	Standard Operating Procedure
SSCVR	Solid-State CVR
SSFDR	Solid-State FDR
TC	Transport Canada
TLB	Technical Log Book
TNA	TransAsia Airways
TQ	Torque
TRB	Technical Review Board
TSB	Transportation Safety Board of Canada
USA	United States of America
UTAS	UTC Aerospace Systems
VHP	Virtual Hardware Platform
VMC	Visual Meteorological Conditions
YD	Yaw Damper

# Chapter 1 Factual Information

## 1.1 History of Flight

On 4 February 2015, an ATR-GIE Avions de Transport Regional ATR72-212A (ATR72-600) aircraft, registered B-22816, TransAsia Airways flight GE235, with three pilots, two cabin crew, and 53 passengers was being operated by TransAsia Airways (TNA) on an instrument flight rules (IFR) regular public transport service from Songshan to Kinmen. At 1054<sup>1</sup> Taipei Local Time, three minutes after taking off from runway 10, the aircraft impacted Keelung River, approximately 3 nautical miles (nm) east of Taipei's Songshan Airport. The aircraft was destroyed by impact forces. Forty-three occupants, including three flight crew, one cabin crew, and 39 passengers were fatally injured. The remaining 13 passengers and one cabin crew sustained serious injuries. One passenger received minor injuries.

More than half of the main wreckage was submerged in the middle of the river (see Figure 1.1-1). As the aircraft flew over an overpass before impacting the water, its left wing collided with a taxi with two occupants. The taxi driver sustained serious injuries and the passenger sustained minor injuries.



Figure 1.1-1 GE235 main wreckage

<sup>1</sup> Unless otherwise noted, the 24-hour clock is used in this report to describe the local time of day, Taipei local time, as particular events occurred. Taipei local time is Universal Coordinated Time (UTC) +8 hours.

On the day of the occurrence, the flight crew was assigned to operate two return flights from Songshan to Kinmen. The four sectors were allocated two operating captains and a first officer acting as an observer. The first sector (GE231) from Songshan to Kinmen departed at 0744 and arrived at 0850 without incident. The return sector (GE232) departed Kinmen at 0917 and arrived at Songshan at 1012 was also uneventful.

The third sector (GE235), which was the occurrence flight, was scheduled to depart Songshan at 1045. Captain A, who was the pilot-in-command (PIC), occupied the left seat and was the pilot flying (PF) for the take off, while Captain B occupied the right seat and was the pilot monitoring (PM). The first officer occupied the cockpit jump seat as an observer pilot (OBS).

According to the Flight Data Recorder (FDR) and Cockpit Voice Recorder (CVR) data, GE235 took off from Songshan runway 10 at 1051 in accordance with the MUCHA 2 Quebec standard instrument departure (SID) procedure bound for Kinmen. The take off roll commenced at 1051:39. Four seconds later (1051:43), the PM mentioned that the automatic take off power control system (ATPCS) was not armed. The PF responded with “*really*”<sup>2</sup> and then said “*ok continue to take off*”. The PM replied “*we will continue*”. Seven seconds later, the PM stated “*oh there it is ATPCS armed*”, and then the aircraft became airborne at 1052:01. The landing gear was retracted after achieving a positive rate of climb. The aircraft accelerated and continued to climb. The crew selected an altitude of 5,000 feet (ALT SEL 5,000) and airspeed of 115 knots<sup>3</sup> on the autopilot. The left coupling autopilot was engaged with lateral navigation (LNAV) and indicated airspeed (IAS) modes. At 1052:34 the Songshan tower controller instructed the GE235 flight crew to contact Taipei Approach while the aircraft was commencing a right turn and climbing through an altitude<sup>4</sup> of 1,000 feet.

---

<sup>2</sup> Content in italics is quoted from CVR transcript and may contain translation from Mandarin language.

<sup>3</sup> The speed described in this report is computed air speed.

<sup>4</sup> Unless otherwise noted, the altitude of the aircraft described in this report is radio altitude.

At 1052:38, when the aircraft was continuing the right turn and climbing through 1,200 feet, the FDR indicated that engine number 1 (ENG 1) was operating in an uptrim condition with its bleed valve closed. That corresponded with the beginning of an ATPCS sequence, which included the auto feathering<sup>5</sup> of the engine number 2 (ENG 2) propellers. The master warning (MW) annunciated in the cockpit and the ENG 2 propeller pitch angles started to advance to the feather position accompanied by the indication of the “ENG 2 FLAME OUT AT TAKE OFF” procedure on the engine warning display (EWD).

At 1052:41, the autopilot was disconnected as the aircraft climbed through an altitude of 1,300 feet. Three seconds later at 1052:44, the ATPCS sequence ended and the ENG 2 propeller was fully feathered. At 1052:43 the PF stated “*i will pull back engine one throttle*”. The PM responded “*wait a second cross check*”, but the ENG 1 power lever angle (PLA<sup>6</sup>) had already been retarded from 75 degrees to 66 degrees. The PF and PM then both announced heading mode, and continued the flight. At 1052:51, the aircraft was climbing through 1,485 feet at 106 knots, with a heading of 131 degrees. The automatic flight control system (AFCS) indicated that HDG SEL and IAS modes were selected. At 1052:57, the selected heading was altered to 092 degrees and the aircraft then started turning to the left at an airspeed of 106 knots.

At 1053:00, the PM stated “*okay engine flame out check*”. The PF responded “*check*” and the PM stated “*check uptrim yes, auto feather yes*”. At 1053:05 the PF responded “*okay*”. At almost the same time, the PM stated “*watch the speed*” because the indicated airspeed had reduced to 101 knots. The PF then announced “*pull back number one*”, and the ENG 1 PLA was retarded to 49 degrees. While the ENG 1 power lever was retarded, the PM said “*okay now number two engine flameout confirmed*”, and the PF responded “*okay*” but the ENG 1 PLA still remained at 49 degrees.

---

<sup>5</sup> Feathering of the propeller is where the propeller blades are rotated parallel to the airflow to reduce drag in case of an engine failure.

<sup>6</sup> The PLA signal is from mechanical fuel control unit (MFCU) angle and is recorded on the FDR.

At 1053:09, the aircraft had climbed to 1,630 feet, which was the highest altitude recorded for the occurrence flight. The indicated airspeed was 102 knots. The AFCS IAS mode then reverted into PITCH HOLD mode<sup>7</sup> and one second later the stall warning annunciated in the cockpit for one second. The PF then stated “*terrain ahead*” and the PM replied “*okay lower...*” and the OBS said “*you are low*”. At 1053:13 the stall warning sounded for four seconds and the stick shakers<sup>8</sup> activated. The PM stated “*okay push, push back*”, to which the PF stated “*shut*”. The PM responded “*wait a second...throttle throttle*”.

Between 1053:13 and 1053:15, the ENG 2PLA was advanced to 86 degrees and the ENG 1PLA was retarded to around 34.5 degrees (idle position). At 1053:18, the aircraft was heading 087 degrees but in a continuous left turn with a 10 to 20 degree angle of bank, descending through 1,526 feet at an airspeed of 101 knots. At 1053:19 the PF said “*number one*” followed by “*feather shut off*”. The PM called “*number feather*”, and then the stick shakers and stick pushers<sup>9</sup> activated several times until 1053:27. At 1053:24, the FDR indicated that the ENG 1 condition lever was in the fuel shut off position, and six seconds later the ENG 1 propeller had attained the feathered position. The aircraft’s indicated airspeed was 110 knots at an altitude of 1,165 feet and descending.

At 1053:35, the PM declared an emergency (Mayday) to air traffic control (ATC). The aircraft was heading 050 degrees and had commenced to bank to the right. From

---

<sup>7</sup> According to the ATR, the ATR72 IAS mode has two different sub-modes: take off sub-mode and cruise sub-mode. The two sub-modes are the guidance system internal logics. The IAS take off sub-mode is engaged two seconds after lift-off and replaced by IAS cruise sub-mode three minutes after lift-off. The IAS take off sub-mode guidance primarily maintains the IAS target but also ensures a minimum ascending slope. The minimum ascending slope is monitored by a “flight path angle (FPA) protection term” which is compared to the “IAS control term”. The FPA protection term becoming greater than the IAS control term means that the airplane has no sufficient energy to continue climbing with that minimum slope at the selected airspeed. If this condition is met for 20 seconds, the IAS mode automatically disengages and reverts to PITCH HOLD mode.

<sup>8</sup> The stick shaker was part of the aircraft’s stall warning system, and indicated to the crew when the aircraft was approaching an aerodynamic stall by activating electrical motors that caused both pilots’ control columns to vibrate rapidly.

<sup>9</sup> In the event of an aerodynamic stall, the aircraft was equipped with a stick pusher that automatically decreased the aircraft’s angle-of-attack.

1053:46 to 1054:04, the flight crew tried to engage the autopilot twice, but they did not succeed. At 1053:53, the OBS said “*how come it becomes like this*”. At 1054:05, the PM stated “*both sides...lost*” and two seconds later the PM realized and stated “*no engine flameout we lost both sides*”. At 1054:09, the PF stated “*restart the engine*”, when the altitude was 545 feet with an airspeed of 105 knots. He subsequently repeated “*restart the engine*” seven times.

At 1054:20, the ENG 1 condition lever was moved out of the shut off position and at 1054:25, the ENG 1 high pressure speed (NH1) increased to 30%. The aircraft’s altitude and indicated airspeed at that time were 400 feet and 106 knots respectively. The aircraft also started to bank to the left. At 1054:27, the PF said “*wow pulled back the wrong side throttle*”. From that time on, the aircraft entered an aerodynamic stall from which it did not recover.

At 1054:34, the enhanced ground proximity warning system (EGPWS) “pull-up” warning was annunciated in the cockpit. At 1054:35 the aircraft’s left bank angle increased from 10 to 80 degrees. The aircraft’s left wing then collided with a taxi driving on the overpass. The wing then impacted the fence and a light pole at the edge of the overpass located southwest of the Keelung river occurrence site (see Figure 1.1-2). The aircraft continued to bank to the left after those collisions and then entered the river inverted.



Figure 1.1-2 GE235 loss of control and initial impact sequence.

## 1.2 Injuries to Persons

There were a total of 58 persons on board including three pilots, two cabin crew, and 53 passengers. Four crew members and 39 passengers sustained fatal injuries. Thirteen passengers and one cabin crew sustained serious injuries and one passenger

sustained minor injuries.

The aircraft's left wing collided with a taxion an overpass before the aircraft entered the river. The taxi driver sustained serious injuries and the only taxi passenger sustained minor injuries.

Table 1.2-1 Injury table

Injuries	Flight Crew	Flight Attendants	Passengers	Other	Total
Fatal	3	1	39	0	43
Serious	0	1	13	1	15
Minor	0	0	1	1	2
None	0	0	0	Not applicable	0
Total	3	2	53	2	60

### 1.3 Damage to Aircraft

The aircraft was destroyed by impact forces as it entered the river.

### 1.4 Other Damage

A taxi travelling on the overpass was substantially damaged by the collision with the aircraft's left wing. Part of the overpass fence or guardrail and a light pole were also damaged.

### 1.5 Personnel Information

#### 1.5.1 Flight Crew Background and Experience

##### 1.5.1.1 Captain A

Captain A, a Republic of China citizen, had served in the Air Force as a pilot. After retiring from the Air Force, he joined a local airline in September 2009 where he undertook Airbus A330 transition training between September 2009 and March 2010. He did not complete the training successfully because he was unable to meet the airline's pilot performance standards and requirements. He subsequently left the airline in March 2010.



Captain A then joined TNA in August 2010 where he successfully completed initial training on the ATR72-500 in February 2011 and subsequently served as a first officer on the ATR72-500 fleet. In August 2014, he completed ATR72-500 command upgrade training and was promoted to captain. In November 2014, he completed differences training and was transferred to the ATR72-600 fleet as a captain.

As of the date of the occurrence, he had accumulated 4,914 total flight hours, including 3,151 hours in the ATR72-500, and approximately 250 hours in the ATR72-600.

Captain A held an air transport pilot license (ATPL) issued by the Civil Aeronautics Administration (CAA) with multi-engine land, instrument, and type rating on both ATR72-500/600, endorsed with privileges for operation of radiotelephone on board an aircraft with no limitations and a current ICAO Level 4 English language proficiency.

#### **1.5.1.2 Captain B**

Captain B was a Republic of China citizen. He joined TNA in June 2006. He successfully completed first officer training in August 2007 and served as a first officer on the ATR72-500 fleet. He successfully completed command upgrade training in September 2011 and was promoted to captain. In February 2014, Captain B completed ATR72-600 differences training and was transferred to the ATR72-600 fleet as a captain.

As of the date of occurrence, he had accumulated 6,922 total flight hours, including 5,687 hours on the ATR72-500 and 795 hours on the ATR72-600.

Captain B held an air transport pilot license (ATPL) issued by the CAA with multi-engine land, instrument, type ratings on the ATR72-500/600, endorsed with privileges for operation of radiotelephone on board an aircraft with no limitations and a perpetually valid ICAO Level 6 English language proficiency.

#### **1.5.1.3 First Officer**

The first officer, a Republic of China citizen, joined TNA in October 2008. He successfully completed ATR72-500 transition training in November 2009 and served as a first officer on the ATR72-500 fleet. In January 2015, he commenced ATR72-600 differences training and was still under training on the date of the occurrence. The first officer had previously flown McDonnell Douglas MD-82 aircraft at another airline before joining TNA.

As of the date of occurrence, he had accumulated 16,121 total flight hours, including 7,911 hours on the MD-82, 5,306 hours on the ATR72-500, and 8 hours on the ATR72-600.

The first officer held an air transport pilot license (ATPL) issued by the CAA with multi-engine land, instrument, type ratings on the ATR72-500/600 and MD-80s, endorsed with privileges for operation of radiotelephone on board an aircraft limited to first officer on the ATR72-500/600, and a current ICAO Level 4 English language proficiency.

Table 1.5-1 Flight crew basic information

<b>Item</b>	<b>Captain A</b>	<b>Captain B</b>	<b>First Officer</b>
Gender	Male	Male	Male
Age as of the Occurrence	42	45	63
Commenced Employment with TNA	3 January 2011	5 June 2006	4 October 2008
License issued	ATPL – Aeroplane	ATPL – Aeroplane	ATPL – Aeroplane
Aircraft Type Rating	ATR72-600	ATR72-600	ATR72-600
Date of expiry	04 November 2019	29 December 2018	22 June 2017
Medical certificate issued	First class	First class	First class
Date of expiry	31 March 2015	31 March 2015	28 February 2015
Total flight time	4,914 hr. and 51 min.	6,922 hr. and 58 min.	16,121 hr. and 57 min.
Total flight time on ATR 72-600	250 hr. and 44 min.	794 hr. and 55 min.	8 hr. and 6 min.
Total flight time last 12 months	877 hr. and 29 min.	788 hr. and 27 min.	888 hr. and 16 min.

<b>Item</b>	<b>Captain A</b>	<b>Captain B</b>	<b>First Officer</b>
Total flight time last 90 days	246 hr. and 30 min.	202 hr. and 23 min.	165 hr. and 51 min.
Total flight time last 30 days	82 hr. and 38 min.	68 hr. and 21 min.	9 hr. and 52 min.
Total flight time last 7 days	18 hr. and 15 min.	22 hr. and 42 min.	8 hr. and 6 min.
Total flight time last 24 hours	4 hr. and 42 min.	4 hr. and 42 min.	0 hr. and 0 min.
Available rest period before occurrence	16 hr. and 35 min.	16 hr. and 35 min.	20 hr. and 30min.

## **1.5.2 Flight Crew Training Record**

### **1.5.2.1 Captain A**

#### **Initial Training in Previous Airlines**

Captain A received A330 initial transition training from September 2009 to March 2010. During the training process, an additional 14 hours of ground school, 8 hours on the MFTD<sup>10</sup>, 2 oral tests, 1 interview, and 3 TRBs<sup>11</sup> were conducted to address the pilot’s skill and knowledge deficiencies identified during training. In addition, given the pilot’s training performance, four instructors requested that the pilot undertake remedial training during the simulation phases (FBS<sup>12</sup> and FFS<sup>13</sup>).

Captain A could not meet the airline’s pilot performance standards and requirements despite the additional remedial training. The flight training department subsequently decided to discontinue his training on 30 March 2010. The concluding training report noted the following areas of concern:

- Multi-Tasks handling/management ability was not able to catch flight progress, left behind aircraft was observed from time to time;
- Insufficient situational awareness and confidence. Unable to prioritize and make

---

<sup>10</sup> MFTD: maintenance/flight training device.

<sup>11</sup> TRBs: technique review boards.

<sup>12</sup> FBS: fixed based simulator.

<sup>13</sup> FFS: full flight simulator.

correct decisions in both normal and abnormal situation; and

- Lack of resistance to stress. Unsteady performance under high workload situations. Unable to handle multi-task at the same time.

### **Initial Training in TNA**

Captain A received ATR72-500 initial training from 16 August 2010 to 18 February 2011. He successfully completed the initial training and passed the first officer line check on 4 March 2011.

### **Upgrade Training**

Captain A commenced ATR72-500 command upgrade training on 14 April 2014. He passed the ground school and simulator training but failed the simulator check on 31 May 2014 with the following unsatisfactory items: “ABNORMAL ENG START”; “BOTH HYD SYS LOSS”; and “S/E APP GO AROUND”. The check airman’s comments included:

- Incomplete procedure check and execution;
- Insufficient knowledge of QRH (ENG FLAME OUT AT T/O, BOTH HYD SYS LOSS);
- Did not fully advance power levers to ramp position during the SINGLE ENGINE APP GO AROUND;
- Did not follow SOP for ENG FIRE operation while on short final and altitude below 400 feet; and
- Cockpit management and flight planning needs improvement.

A technical review board (TRB) to discuss the pilot’s performance was convened on 19 June 2014. The TRB decided to provide Captain A an additional simulator session followed by a simulator re-check between 29 and 30 June 2014. The additional simulator training session was conducted by the Flight Operations Department’s (FOD) Assistant Vice-President who was a senior instructor pilot (IP). As a qualified senior check pilot (CP), the company’s ATR Chief Pilot conducted Captain A’s re-check.

Captain A successfully completed the additional simulator training session and subsequently passed the simulator check. He was promoted to captain on 1 July 2014.

Captain A then completed line training from 2 July to 10 August 2014. Evaluations of the pilot's performance by the IPs delivering the line training included:

- Prone to be nervous and may make oral errors during the engine start procedure;
- Insufficient knowledge leading to hesitations in "Both EEC Failure" and "Engine Failure after V1" situation during the oral test;
- Lack of confidence and being nervous while answering the Smoke procedure during the oral test;
- Incomplete check and execution of certain procedures;
- Hesitant when facing situations that require making decisions; and
- Flight planning should be improved.

### **Differences Training**

Captain A attended a one-week ATR72-500/600 differences training course at the ATR Training Center in Singapore from 27 to 31 October 2014. That training comprised ground training and simulator training. The associated line training was undertaken at TNA.

The assessment of the pilot's performance during the virtual hardware platform (VHP) trainer sessions in the first 4 days were "*Progress is Normal*" with instructors' comments of "*Good Job*". However, the assessment of the pilot's performance during the full flight simulator (FFS) session on the final day of training noted that the pilot "*MAY NEED extra training*<sup>14</sup>" with an instructor commenting "*check EFATO*<sup>15</sup>

---

<sup>14</sup> The ATR stated that the "MAY NEED extra training" is used when an instructor wants to reinforce his opinion before validating a specific task or competence. This can be done by another instructor or himself during the next normal session or test (no extra training time required at this step). There are 2 possibilities after a "May need extra training" assessment: Either the same or another instructor is happy with the performance demonstrated later and no extra training is required. Or the second demonstration is showing a weakness and then some extra training time is required.

<sup>15</sup> EFATO: engine flame out at take off. Also known as an engine failure after take off.

*callout and Task sharing and GA<sup>16</sup>Single Engine”.*

Captain A passed the ATR72-600 simulator check and was authorized to captain the ATR72-600 aircraft on 2 November 2014. The areas for improvement that were previously identified were assessed again during the simulator check and the pilot’s performance was found to be "Satisfactory" - "all STD<sup>17</sup>". He subsequently passed the ATR72-600 line check on 11 November 2014 and began operating as an ATR72-600 captain.

### **Recurrent Training**

Captain A’s most recent annual proficiency training and checks were consolidated with his command upgrade and difference training conducted in 2014. The records indicated that the pilot had passed the required checks.

### **1.5.2.2 Captain B**

#### **Initial Training**

Captain B commenced ATR72-500 first officer initial training on 22 March 2007. That training comprised six phases: phase one “basic ground training”; phase two “airplane type ground training”; phase three “observation flights”; phase four “simulator training”; phase five “local training”; and phase six “initial operating experience (IOE) line training”. He completed the initial training successfully on 14 August 2007 and qualified as an ATR72-500 first officer. No items of concern were noted in Captain B’s first officer training records.

#### **Upgrade Training**

Captain B commenced ATR72-500 command upgrade training on 27 June 2011. That training comprised ground training, simulator training, and line training. He completed upgrade training successfully on 3 September 2011 and qualified as an

---

<sup>16</sup> GA: go-around. A go-around is an aborted landing of an aircraft that is on final approach.

<sup>17</sup> STD: standard. That is, the pilot met the required performance standard.

ATR72-500 captain. There were no areas of concern noted during Captain's B command upgrade training.

### **Differences Training**

Captain B commenced ATR72-600 differences training on 16 December 2013 at the ATR Training Center in Singapore. That training comprised ground training and simulator training. The associated line training was undertaken at TNA. He successfully completed the differences simulator check on 21 December 2013. The comment from the JAA<sup>18</sup> certified examiner was "Standard Session". The subsequent line check was conducted successfully on 25 February 2014. The comment from the JAA certified examiner was "Good Job, Satisfactory". There were no other significant comments regarding these checks.

### **Recurrent Training**

Captain B completed eight hours of annual recurrent ground training on 4 December 2014. The training syllabus comprised adverse weather operations, normal/abnormal procedures, including the roles of PF/PM and other flight crew task sharing, positive transfer of aircraft control, consistent checklist philosophy, emphasis on the priorities of "aviate, navigate, communicate", correct use of all levels of flight automation, correct crew response to system malfunction/s, and aircraft type systems and limitations.

Captain B's most recent proficiency training (PT) was conducted on 6 December 2014. The training syllabus included stall recovery, unusual attitude recovery, and engine flame out at take off. The JAA certified IP assessed Captain B's performance as "Satisfactory, Good Job".

Captain B's most recent proficiency check (PC) was conducted on 7 December 2014. The pilot passed the check. Captain B's evaluation was annotated with "aircraft

---

<sup>18</sup> JAA: European Joint Aviation Authorities.

maneuvering and procedures are conducted in accordance with standards, general handling of emergency, general CRM”. The most recent line check was consolidated with the differences line check, which was successfully completed on 25 February 2014.

### **1.5.2.3 First Officer**

#### **Transition Training**

The first officer (FO) had experience as an MD-82 captain with his previous airline. TNA hired him as a first officer for the ATR72.

The FO commenced ATR72-500 transition training on 16 June 2008. The training syllabus included ground training, line observation training, simulator training, local training, and line training. The FO failed his first ATR72-500 simulator check. The examiner commented that he “Could not properly identify abnormal engine start. Not properly handle standard callouts, engine flame out, engine fire, and go around.”

After undertaking remedial training, the FO subsequently passed the simulator check on 19 September 2008. He completed ATR72-500 transition training on 8 November 2008 with a satisfactory line check.

#### **Recurrent Training**

The FO completed eight hours of annual recurrent ground training on 12 September 2014. The training syllabus comprised adverse weather operations, normal/abnormal procedures, including the roles of PF/PM and other flight crew task sharing, positive transfer of aircraft control, consistent checklist philosophy, emphasis on the priorities of "aviate, navigate, communicate", correct use of all levels of flight automation, correct crew response to system malfunction/s, and aircraft type systems and limitations.

The FO’s most recent proficiency training and check were conducted on 17 and 18 September 2014 respectively. The training syllabus included stall recovery, unusual



attitude recovery, and engine flame out at take off. The FO's training performance was assessed as "Satisfactory" and he passed the subsequent check. The FO also passed his most recent annual line check on 26 November 2014.

### **Differences Training**

The FO commenced ATR72-600 differences training on 12 January 2015 at the ATR Training Center in Singapore. That training comprised ground training and simulator training. The associated line training was undertaken at TNA.

While he passed the differences simulator check on 19 January 2015, the examiner commented that the FO "*will need some time to get used to the 600 (ATR72-600), flying with an experienced captain is strongly recommended.*"

As at the date of occurrence, the FO was still undergoing ATR72-600 differences line training. The occurrence flight was an observation flight for the FO.

## **1.5.3 Flight Crew Medical Information**

### **1.5.3.1 Captain A**

Captain A's first class medical certificate was issued by the CAA on 3 September 2014 with the limitation that the "*Holder shall wear corrective lenses*".

### **1.5.3.2 Captain B**

Captain B's first class medical certificate was issued by the CAA on 12 September 2014 with no limitations.

### **1.5.3.3 First Officer**

The FO's first class medical certificate was issued by the CAA on 2 October 2014 with the limitation that the "*Holder shall wear corrective lenses*".

## **1.5.4 Flight Crew Activities within 72 Hours before the Occurrence**

### **1.5.4.1 Captain A**

- 1 February 2015: Reported to Songshan Airport at 0640 and operated scheduled

flights from Songshan to Kinmen to Songshan to Kinmen to Songshan. Total flight time was 4 hours 26 minutes. The flight duty ended at 1405.

- 2 February 2015: Day off.
- 3 February 2015: Reported to Songshan Airport at 0640 and operated scheduled flights from Songshan to Kinmen to Songshan to Kinmen to Songshan. Total flight time was 4 hours 30 minutes. The flight duty period ended at 1405.
- 4 February 2015: Reported to Songshan Airport for duty at 0640.

#### **1.5.4.2 Captain B**

- 1 February 2015: Reported to Songshan Airport at 1320 and operated scheduled flights from Songshan to Kinmen to Songshan to Hualien to Songshan. Total flight time was 3 hours 44 minutes. The flight duty ended at 1935.
- 2 February 2015: Day off.
- 3 February 2015: Reported to Songshan Airport at 0640 and operated scheduled flights from Songshan to Kinmen to Songshan to Kinmen to Songshan. Total flight time was 4 hours 30 minutes. The flight duty ended at 1405.
- 4 February 2015: Reported to Songshan Airport for duty at 0640.

#### **1.5.4.3 First Officer**

- 1 February 2015: Day off.
- 2 February 2015: Went to office for self-study from 0830 to 1730, and then went home.
- 3 February 2015: Day off.
- 4 February 2015: Reported to Songshan Airport at 0640 for duty as an observer.

### **1.6 Aircraft Information**

#### **1.6.1 Aircraft and Engine Basic Information**

Basic information of the occurrence aircraft is shown in Table 1.6-1.

Table 1.6-1 Aircraft basic information

<b>Aircraft basic information</b> (statistics date: 4 February 2015)	
Nationality	Taiwan, R.O.C.
Aircraft registration number	B-22816
Manufacturer	ATR-GIE Avions de Transport Régional
Aircraft model	ATR72-212A <sup>19</sup>
Aircraft serial number	1141
Date manufactured	14 April 2014
Delivery date	14 April 2014
Owner	TransAsia Airways
Operator	TransAsia Airways
Number of certificate of registration	103-1271
Certificate of airworthiness, validity date	31 March 2015
Total flight time (hours: minutes)	1,627:05
Total flight cycles	2,356
Last check, date	A4 CHECK, 26 January 2015
Flight hours/ cycles elapsed since last check	44:50 / 64

Basic information for the two Pratt & Whitney Canada (PWC) engines is shown in Table 1.6-2.

Table 1.6-2 Engine basic information

<b>Engine basic information</b> (statistics date: 4 February 2015)		
Number/position	No. 1/ Left	No. 2/ Right
Manufacturer	PWC	PWC
Model	PW127M	PW127M
Serial number	ED0913	ED0814
Manufacture date	9 May 2014	19 November 2013
Installation date	16 August 2014	7 February 2014
Time since installation (hours: minutes)	829:31	1627:05
Cycle since installation	1240	2356
Last check, date	A4 CHECK, 26 January 2015	A4 CHECK, 26 January 2015
Time / cycles since last check	44:50 / 64	44:50 / 64

## 1.6.2 Aircraft Maintenance Records

A review of the aircraft’s maintenance records before the occurrence flight

<sup>19</sup> ATR72-212A: model as per type design; ATR72-500: marketing name for legacy ATR72-212A; ATR72-600: marketing name for ATR72-212A with new avionic suite.

indicated that there were no defects reported or inoperative items under the minimum equipment list (MEL<sup>20</sup>) for the occurrence flight when the aircraft was dispatched from Songshan Airport. A review of the aircraft's maintenance documentation was conducted and included an examination of the following:

- Technical log books (TLBs) from the date of aircraft delivery to the occurrence date;
- Pre-flight checks, daily checks, and transit check records for the last 6 months before the occurrence; and
- The last periodic check (A4 check).

That review indicated that no defects were reported regarding the ENG 2 autofeather system.

The deferred defect (DD) records, status of airworthiness directives (ADs) and service bulletins (SBs) for the occurrence aircraft were also reviewed. The control of the DD records for the occurrence aircraft was in compliance with CAA regulations and no DD items related to the ENG 2 autofeather system were found. The review also concluded that the aircraft was in compliance with all applicable ADs and SBs.

### **1.6.3 Propeller Systems**

The occurrence aircraft was equipped with HAMILTON STANDARD 568F-1 propellers. The propellers are the variable pitch type, hydro mechanically controlled, and can be placed in the reverse or feathering configurations. According to the aircraft maintenance manual, description / operation (AMM D/O) (revision number 38, revision date 1 December 2014), the propeller's operating modes include governing speed mode, synchrophasing, governing pitch mode, and feathering / unfeathering modes.

---

<sup>20</sup> A minimum equipment list (MEL) is a list of aircraft equipment and systems that may be inoperative for flight, subject to specified conditions. The MEL is approved by the State of the Operator and will enable the pilot-in-command to determine whether a flight may be commenced or continued from any intermediate stop should an instrument, equipment or systems become inoperative.

Feathering can be performed:

- Manually, by the condition lever in case of engine failure;
- Automatically, in case of torque decrease at takeoff on one engine;
- Manually, by the fire handle in case of engine fire; and
- Manually, during maintenance operations.

#### **1.6.4 Automatic Take off Power Control System**

The automatic take off power control system (ATPCS) is one of the sub-systems of the propulsion unit. The ATPCS is designed to automatically feather the propeller during takeoff and approach if the engine torque decreased below 18.5 percent rated torque. The auto-feather logic and control circuits with interlock features provided arming control and prevented auto-feather of the operating propeller, once the auto-feather sequence for one of the propellers was initiated. The system also provided for relaying a 'power uptrim' (engine power increase) signal to the operating engine.

ATPCS operates with an auto feather unit (AFU) on each engine. The AFU conditions torque signal and includes autofeather/uptrim logic functions, it delivers signal to MFC, which then delivers signals to the engine electronic control (EEC) to enable power increase from takeoff power to reserved take off power, to the feather solenoid mounted on the propeller valve module (PVM), and the feathering electric pump installed on the reduction gear box on each engine.

The associated controls in the cockpit included the ATPCS push button on the cockpit center panel (see Figure 1.6-1), the power lever (PL) position and a test selector located on the cockpit pedestal. Arming of the system was performed when all the following conditions were simultaneously met (Figure 1.6-2):

- Power management (PWR MGT) selector switch placed in TO (take off) position;
- ATPCS pushbutton switch pressed in;
- Engines 1 and 2 torque higher than 46.2%; and
- Both power lever angles above 49 degrees.

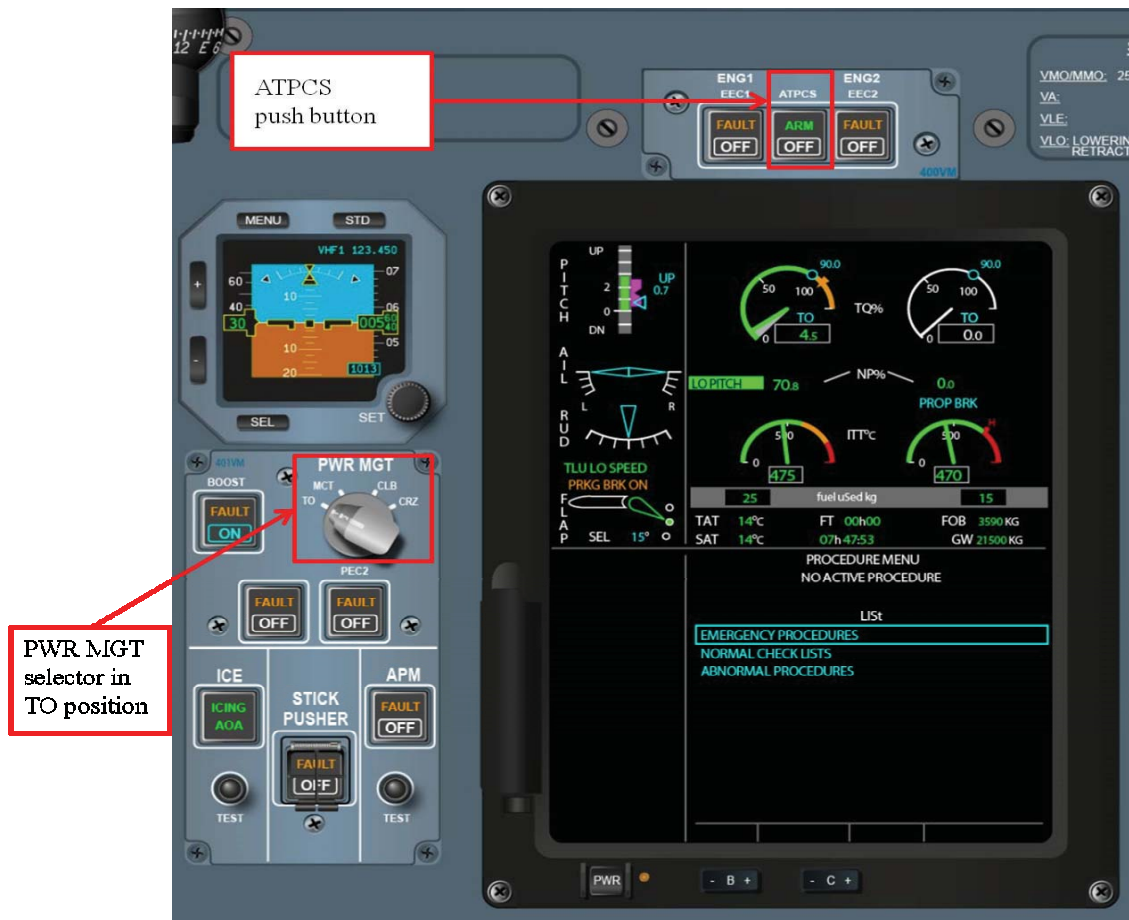

Figure 1.6-1 PWR MGT selector and ATPCS pushbutton

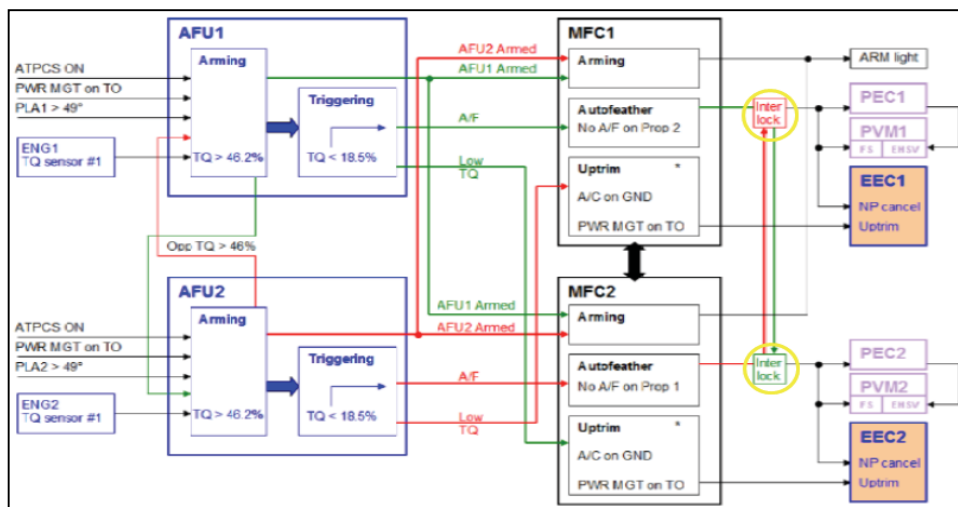

Figure 1.6-2 Functions of the ATPCS

The status of the ATPCS was indicated by the ATPCS ‘ARM’ indicator on the cockpit center panel. When armed, the ATPCS ‘ARM’ illuminated green. If one engine’s torque decreased below 18.5 percent, the ATPCS relayed an uptrim (engine power increase) command to the other engine. The uptrim resulted in increasing the remaining operating engine power from takeoff (TO) to reserve take off (RTO) power. After 2.15 seconds, the propeller of the faulty engine was automatically feathered by activation of the propeller valve module (PVM) feather solenoid and in parallel by the PVM electro hydraulic servo valve (EHSV) controlled by the propeller electronic control (PEC) unit. The interlock system then precluded automatic feathering of the operating engine to ensure that both engines were not feathered at the same time. The sequence of technical events when the ATPCS was triggered is shown in Figure 1.6-3.

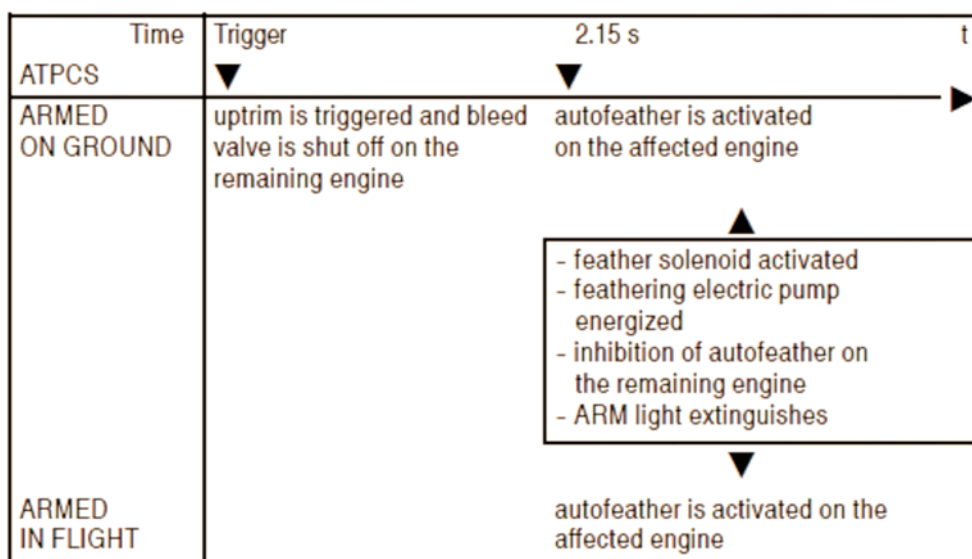

Figure 1.6-3 The ATPCS sequence after trigger

Once the ATPCS sequence has been triggered, it can only be cancelled by the following actions: PWR MGT selector not in TO position, ATPCS push button set to OFF position or retard both power levers (PL) below 49°. When the ATPCS is triggered, the engine and warning display (EWD) will indicate "UP TRIM" on the operating engine, "AUTO FTR" on the affected engine and the procedure for ENG 1(2)

FLAME OUT AT TAKE OFF. Figure 1.6-4 and Figure 1.6-5 illustrate simulated EWD displays for ENG 2 autofeathered and "ENG 2 FLAME OUT AT TAKE OFF" procedure.



Figure 1.6-4 Simulated EWD indications for ENG 2 autofeather at take off<sup>21</sup>

<sup>21</sup> According to ATR 72 FCOM, engine torque indication (TQ%) includes a digital counter and an analogic pointer. The digital counter displays actual digital torque indication and the readout is green if torque is in green sector, amber if in amber sector, and white in red reversed video if above amber sector limit. The analogic pointer stays green when torque is below 100% (green sector). It will become amber if torque is between 100 – 106% (amber sector), and red if torque is higher than 106%. During an engine flame out event, the operative engine will apply an additional 10% of torque (RESERVE TAKE OFF), to a level of 100%, comparing to normal take off torque of 90%. During RESERVE TAKE OFF, TQ indication may exceed 100% but not 106.3%.



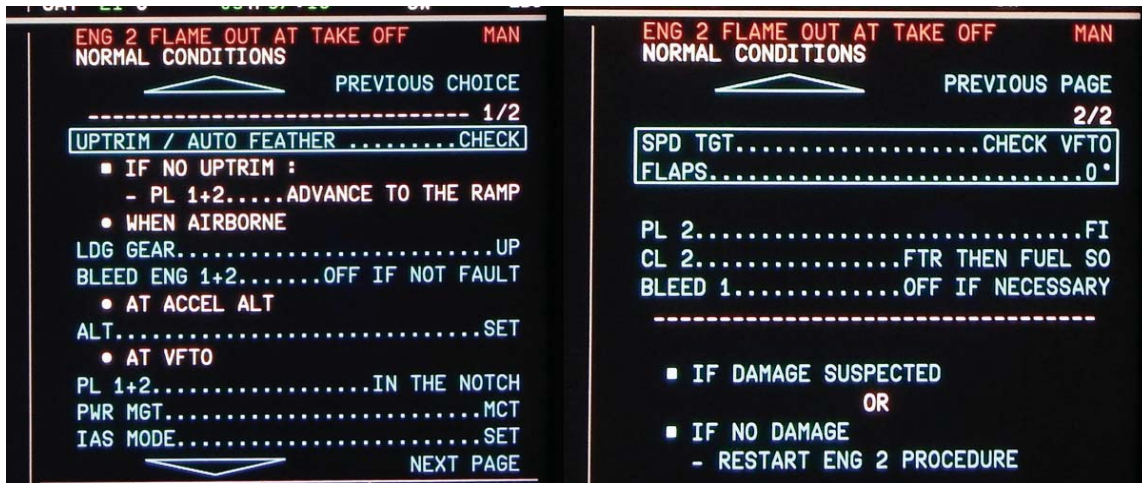

Figure 1.6-5 Simulated EWD indications for ENG 2 flame out at take off

### 1.6.5 Engine Torque Sensing and Indication

Engine torque was one of the indicators of engine power. Each engine contained two torque sensors which were located on the reduction gearbox casing. Torque sensors were used to measure the torque produced by the engine.

As shown in Figure 1.6-6, the signal sensed by the No. 1 and No. 2 sensors was transmitted to the AFU and EEC respectively, where it was converted into engine torque indications. The AFU and EEC transmitted the data to the core avionic cabinet 1 (CAC1) and CAC2. The CAC was supplied with a 5V DC reference voltage and the signal from the AFU, which were then routed to a display unit (DU) through ARINC 429<sup>22</sup> and displayed the torque value in analog form. The digital indication was produced by an ARINC 429 message from the EEC to the DU. The torque value in digital form was also transmitted to the multi-purpose computer (MPC), which enabled the solid state flight data recorder (SSFDR) to capture those indications through ARINC 429.

<sup>22</sup> Digital information transfer system (DITS), also known as aeronautical radio incorporated, is the technical standard for the predominant avionics data bus used on most higher-end commercial and transport aircraft. It defines the physical and electrical interfaces of a two-wire data bus and a data protocol to support an aircraft's avionics local area network.

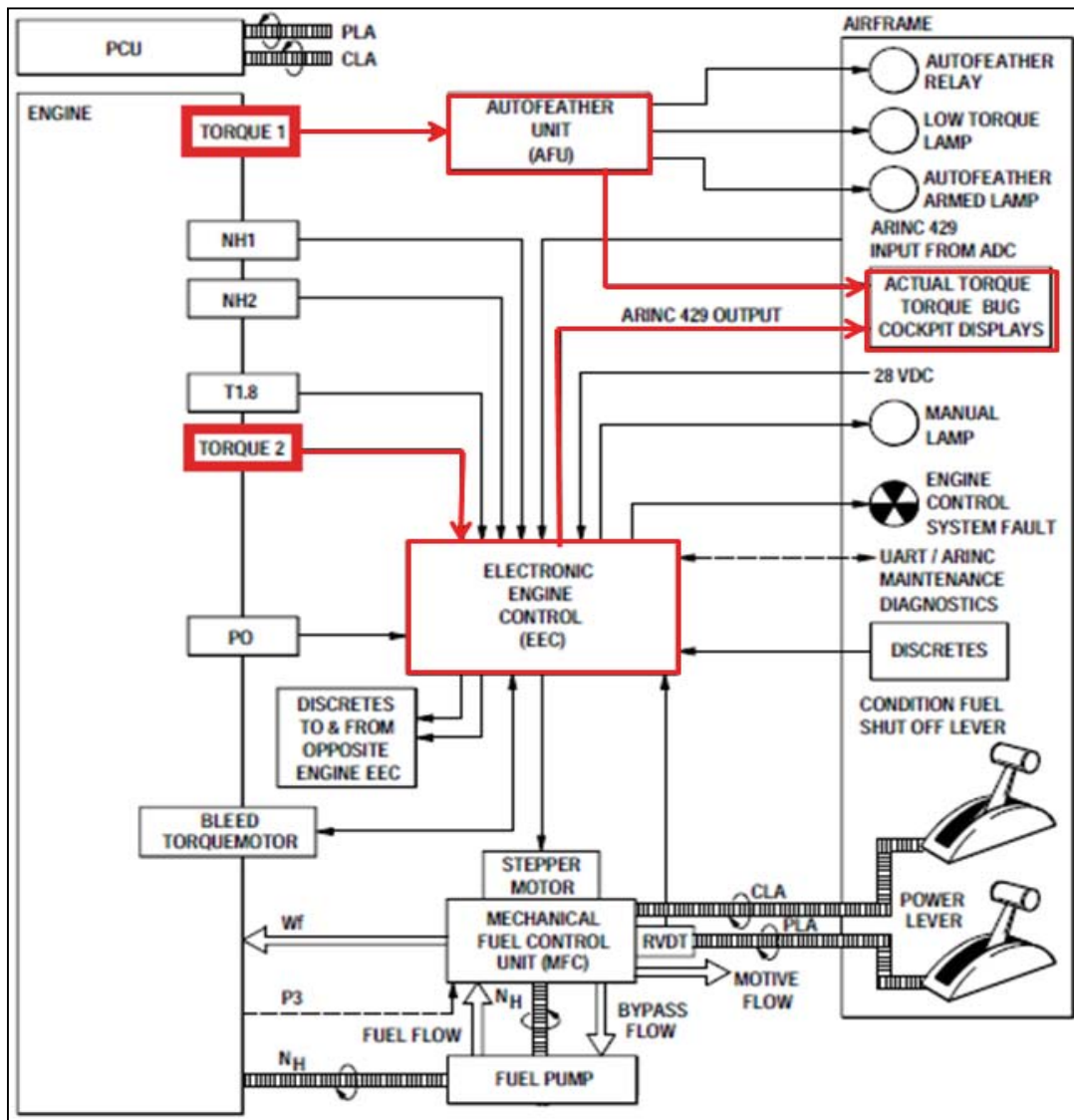

Figure 1.6-6 Engine torque sensing and indication

### 1.6.6 Weight and Balance Information

The actual takeoff weight of the aircraft was 44,890 lbs. The aircraft's center of gravity (CG) for takeoff was located at 27.6% mean aerodynamic chord (MAC), which was within the aircraft's certified CG limitations located between 20.8% and 37% MAC. The ATR72-600 CG envelope is depicted in Figure 1.6-7. Table 1.6-3 details the occurrence aircraft's weight and balance data. The aircraft's weight and balance was

within the specified limitations for the duration of the occurrence flight.

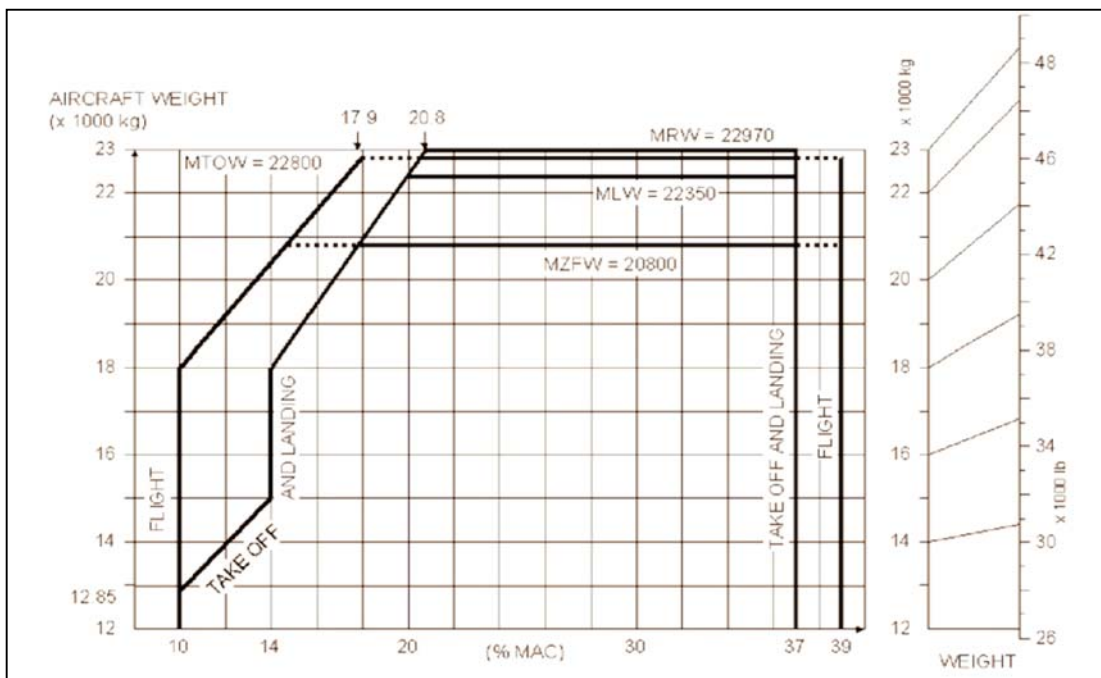

Figure 1.6-7 ATR72-600CG envelope

Table 1.6-3 Weight and balance data

Max. zero fuel weight	45,856 lbs.
Actual zero fuel weight	39,989 lbs.
Max. takeoff weight	50,265 lbs.
Actual takeoff weight	44,890 lbs.
Take off fuel	4,901 lbs.
Estimated trip fuel	1,720 lbs.
Max. landing weight	49,273 lbs.
Estimated landing weight	43,170 lbs.
Take off Center of Gravity	27.6% MAC

MAC: mean aerodynamic chord

## 1.7 Weather Information

The aerodrome routine meteorological report (METAR) for Songshan Airport around the time of the occurrence was:

METAR at 1100 hours, wind from 100 degrees at 10 knots, visibility greater than

10 kilometers, few<sup>23</sup> clouds at 1,500 feet, broken at 2,800 feet, broken at 4,000 feet, temperature 16°C; dew point temperature 13°C, altimeter setting 1024 hPa<sup>24</sup>, trend forecast-no significant change, Remarks: altimeter setting 30.25 in-Hg

Songshan Airport's automatic terminal information service (ATIS) current at the time of the occurrence was information Sierra<sup>25</sup> which indicated that the cloud coverage was 'Few' at 1,300 feet and 'Broken' at 2,800 feet and 4,000 feet. Runway 10 was in use and was reported as 'wet'<sup>26</sup>. Visibility was greater than 10 kilometers and the wind was from 100 degrees at 8 knots. The QNH was 1024 hPa. The temperature was 16°C and the dew point was 13°C. No significant change in the reported weather conditions was expected.

There was no low level wind shear detected around the time of the occurrence. visual meteorological conditions (VMC) prevailed for the take off and maneuvering phases of the occurrence flight.

## **1.8 Aids to Navigation**

There were no reported difficulties with navigational aids along the occurrence aircraft's flight path.

## **1.9 Communication**

Communication with air traffic control (ATC) was primarily through very high frequency (VHF) radio with both Songshan Ground and Tower using separate VHF frequencies of 121.9 and 118.1 MHz respectively.

The ATC radio and hotline communication transcripts are shown in Appendix 1.

### **1.9.1 Communication within the Passenger Cabin**

---

<sup>23</sup> Cloud amounts are reported in oktas. An okta is a unit of sky area equal to one-eighth of total sky visible to the celestial horizon. Few = 1 to 2 oktas, scattered = 3 to 4 oktas, broken = 5 to 7 oktas and overcast = 8 oktas.

<sup>24</sup> The altimeter setting (QNH) is a figure that represents the theoretical mean sea level air pressure at a point. The QNH figure is used to set an altimeter so that it indicates the altitude (height above mean sea level) at that point.

<sup>25</sup> The ATIS information Sierra was issued at time 1030 and still valid at time of occurrence (1054).

<sup>26</sup> The runway surface was soaked but there is no standing water.

Communication between the cabin crew and the flight crew and between the two cabin crew was via the interphone system or in person. There were no reports of any difficulty with the aircraft's interphone system. The senior flight attendant advised the PF (Captain A) that the cabin was ready before the flight crew requested a taxi clearance from Songshan Ground. There was no further communication between the flight crew and the cabin crew. The senior flight attendant advised the passengers to fasten their seatbelts shortly before takeoff. There was no further communication from the flight crew or the cabin crew to the passenger cabin during the short duration of the occurrence flight.

## 1.10 Aerodrome

Taipei Songshan Airport's<sup>27</sup> elevation was 18 feet. It had one runway that was oriented east-west. Runway 10/28 aligned 095/275° magnetic, was 2,605 meters long and 60 meters wide, and was constructed of asphalt and concrete. Runway 10 had a stopway<sup>28</sup> of 51 x 60 meters<sup>29</sup> and an engineered materials arresting system (EMAS)<sup>30</sup> of 122 x 69 meters installed 111 meters east of the Runway 28 threshold. Runway 28 had a runway end safety area (RESA)<sup>31</sup> of 51 x 150 meters.

High terrain, high density residential buildings, commercial buildings, military facilities, and a multitude of other obstacles<sup>32</sup> surrounded the airport and were prevalent along the aircraft's occurrence flight path.

---

<sup>27</sup> RCSS, also known as Taipei International Airport.

<sup>28</sup> The stopway is an area beyond the runway which can be used for deceleration in the event of an aborted takeoff.

<sup>29</sup> The AIP Taipei FIR AD 2-RCSS-37 Songshan aerodrome chart dated 9 Jul 15 included an additional area of 60 x 60 m between the end of the Runway 10 Stopway and the beginning of the EMAS.

<sup>30</sup> An EMAS uses a specially installed surface which quickly stops any aircraft that moves onto it. EMAS may be installed at the end of some runways to reduce the extent, and associated risks, of any overrun off the end of the runway compared to the equivalent soft ground distance. As such it may be an alternative to a runway end safety area (RESA) where the topography precludes the full recommended length of a RESA.

<sup>31</sup> RESA is an area symmetrical about the extended runway center line and adjacent to the end of the strip primarily intended to reduce the risk of damage to an airplane undershooting or overrunning the runway

<sup>32</sup> Other obstacles in the vicinity included water towers with lightning rods attached, various trees, transmission towers and other buildings up to 328 feet in height. Some of the buildings had scaffolding, antennae and/or lighting rods attached.

## 1.11 Flight Recorders

The flight data recorder (FDR) and the cockpit voice recorder (CVR) were recovered by the ASC investigators at 1605 on the occurrence day. Both recorders were immersed in water but exhibited no external damage. The recovered CVR and FDR are shown in Figure 1.11-1.

Both recorders were transported to the ASC Investigation Laboratory for disassembling and readout on 4 February. The crash survival memory units (CSMU) of both the CVR and FDR were in good condition. After cleaning and drying the CSMUs, data from both recorders were successfully downloaded.

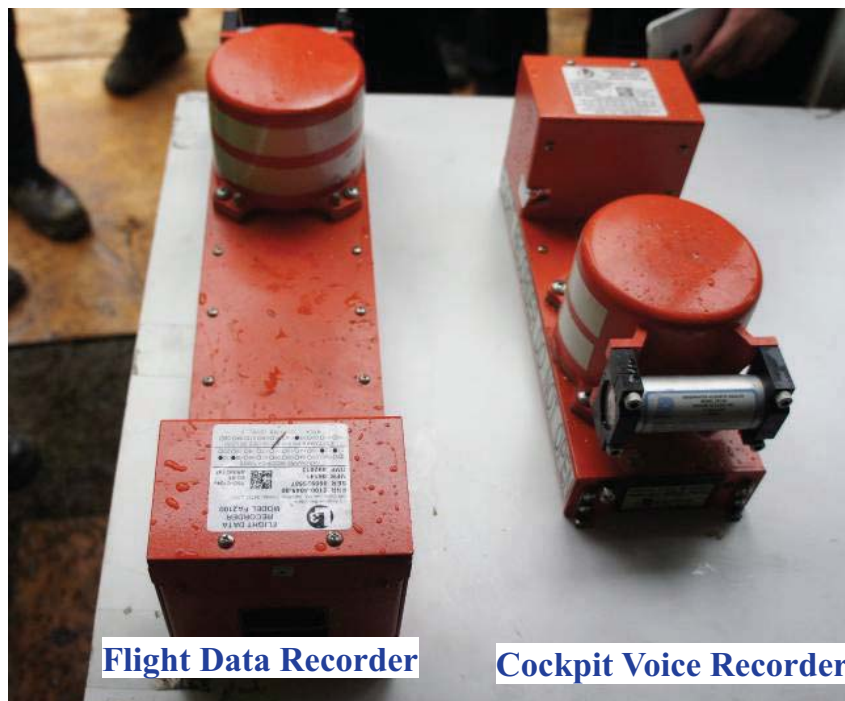

Figure 1.11-1 External view of the FDR and CVR

### 1.11.1 Cockpit Voice Recorder

#### CVR Description

The aircraft was equipped with an L-3 Communications solid-state CVR (SSCVR or CVR), model FA2100. The CVR was capable of recording 2 hours of 4-channel

high quality cockpit audio. The 4 channels of cockpit audio comprised two channels for each flight crew, one cockpit area microphone (CAM) channel, and a fourth channel for the public address (PA) system. The CVR's identifying information included:

- Manufacturer: L-3 Communications
- Model: FA2100
- Part number: 2100-1020-02
- Serial number: 000706983
- Hardware modification number: 13

### **CVR Download and Readout**

The CVR data download was conducted in accordance with the applicable CVR manufacturer's accident investigator's kit (AIK) (Figure 1.11-2). The CVR contained 124 minutes and 14.4 seconds of 4 channel audio data. The audio quality of each channel was either good or excellent. The recording included the occurrence flight and two previous flights, GE231 from Taipei to Kinmen and GE232 from Kinmen to Taipei. The occurrence flight GE 235 began at 1041:15.4 hrs. and ended at 1054:36.6 hrs. It covered from standing, pushback to the occurrence happened. The CVR transcript of the occurrence flight can be found in Appendix 2.

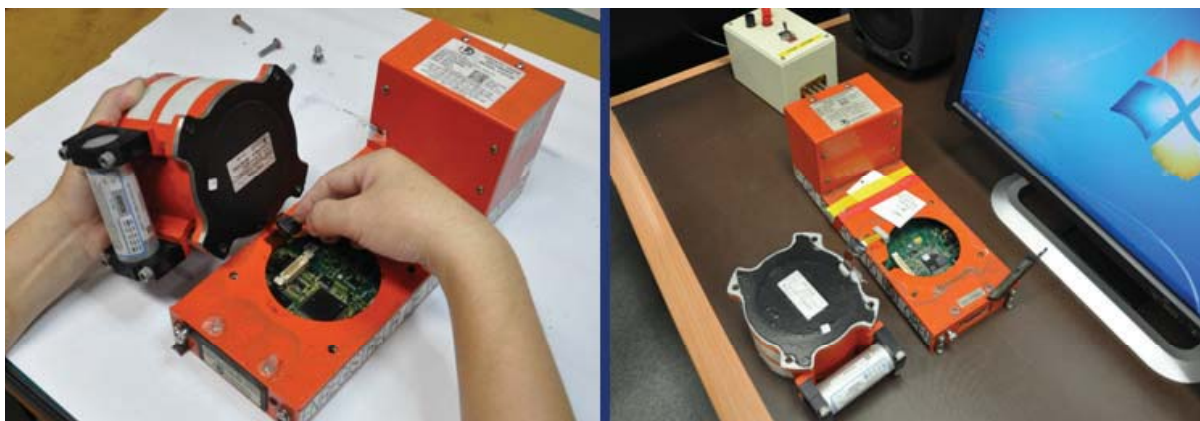

Figure 1.11-2 CVR CSMU connection to chassis

## 1.11.2 Flight Data Recorder

### FDR Description

The aircraft was equipped with an L-3 Communications solid-state flight data recorder (SSFDR or FDR). The FDR's identifying information included:

- Manufacturer: L-3 Communications
- Model : FA2100
- Part Number: 2100-4045-00
- Serial Number: 00925587
- Hardware Modification Number: 12

### FDR Download and Readout

The FDR data download was conducted in accordance with the applicable FDR manufacturer's AIK(Figure 1.11-3).



Figure1.11-3 FDR CSMU connection to chassis

The FDR recording contained 67 hours 22 minutes and 56 seconds of data. The occurrence flight was the last flight of the recording and its duration was 13 minutes and 18 seconds. According to ATR's FDR readout document<sup>33</sup>, the total number of recorded parameters was 750 and the raw data was converted into engineering units.

<sup>33</sup> ATR service letter no. ATR72-31-6010, Rev 10 referring to dataframe V4.



Data plots for the occurrence flight are available in Appendix 3.

GE235's FDR began recording at 1041:18 and continued recording until the end of the flight at 1054:35.9.

### 1.11.3 Other Flight Data and Radar Track Data

#### 1.11.3.1 Quick Access Recorder Data

The aircraft's quick access recorder (QAR) and its personal computer memory card international association (PCMCIA) card were recovered on 5 February. After drying the PCMCIA card, all data was downloaded successfully. The last flight segment data was consistent with the FDR readout data with the exception that the QAR stopped recording at 1054:34.

#### 1.11.3.2 Secondary Surveillance Radar Data

Figure 1.11-4 shows the GE235 ATC radar track superimposed on a satellite image of the area. The three red triangular marks were predicted aircraft positions derived from the radar system. The original radar data indicated that the aircraft's last valid radar data position was recorded at 1054:35.26.



Figure 1.11-4 GE235 ATC radar track

#### 1.11.4 Flight Path Reconstruction

The flight path was determined by three recorded parameters with sampling rate of 1 Hz: GPS latitude; GPS longitude; and baro-corrected altitude. Aircraft position

information was available until 1054:35. The aircraft's last recorded position was N25°03'46.576", E121°37'1.291". Figure 1.11-5 illustrates the aircraft's GPS flight path, ATC radar track, and key warnings in the cockpit superimposed on a satellite photo of the area. The GE235 flight path, satellite image and key events between 1053:07.7 and 1053:59.7 and the last 23 seconds of the flight are presented in Figures 1.11-6 and 1.11-7 respectively.

Table 1.11-1 presents the sequence of technical events for the occurrence based on the CVR and FDR information.



Figure 1.11-5 Superimposed GE235 GPS flight path, ATC radar track and key cockpit warnings



Figure 1.11-6 GE235 flight path and key events rendered on a fused satellite image and digital surface model between 1053:07.7 and 1053:59.7

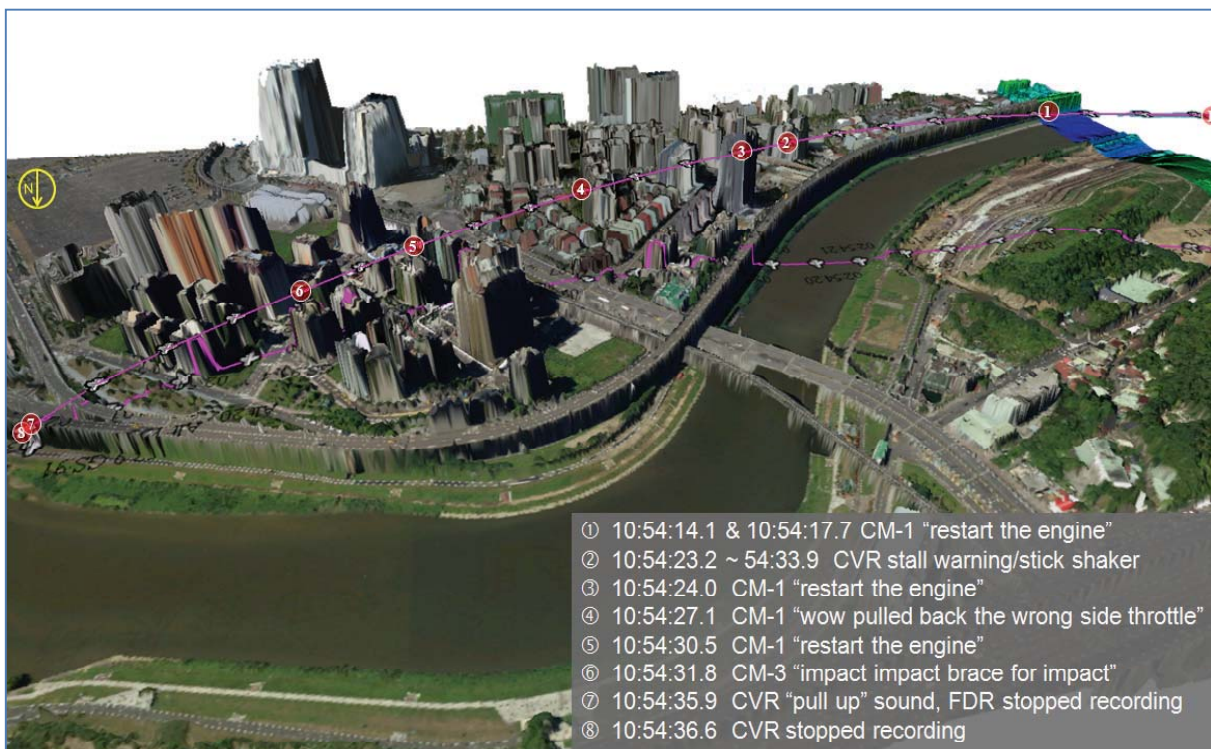

Figure 1.11-7 GE235 flight path and key events rendered on a fused satellite image and digital surface model for the final 23 seconds of flight

Table 1.11-1 GE235 CVR/FDR Sequence of Events

Local Time	Autopilot/Yaw Damper Status (AP/YD)	Radio Altitude (RALT)	Computed Airspeed (CAS)	Indicated Airspeed (IAS1)	Fact	EWD Procedure Message	Comment
					LNAV Armed – Selected speed 115 knots	Before Take Off	
10:51:34			-	-	increased PLA	No Procedure Displayed	TO sequence began
10:51:43			37	37	No ATPCS armed (CVR)		
10:51:52			84	84	ATPCS armed (CVR)		
10:51:59			114	114	V1 (CVR)		
10:52:00			116	116	Parameter discrete main gear=0 ALT armed – Selected altitude 5,000 feet		Airborne
10:52:03		6.4	123	127	highest CAS 134 knots	After Take off	
10:52:08	YD	91	133	135			
10:52:16	YD-AP LNAV IAS	361	129	130			
10:52:37	~	1,165	116	117	ENG 1 uprimed ENG bleed VLV LH closed		ATPCS sequence began (52:35 ~ 52:37)
10:52:38	~	1,193	117	119	Master warning ENG 2 flame out		
10:52:39	~	1,246	117	119	ENG 2 feathering began	ENG 2 Flame Out at Take Off	ATPCS sequence: 2.15 sec after trigger, feathering
10:52:40	YD LNAV IAS	1,283	117	117	AP disconnection		Manual disconnection

Local Time	Autopilot/Yaw Damper Status (AP/YD)	Radio Altitude (RALT)	Computed Airspeed (CAS)	Indicated Airspeed (IAS1)	Fact	EWD Procedure Message	Comment
10:52:42	~	1,352	114	114	ENG 2 propeller feathering (beta angle 78 deg)		ATPCS sequence ended
10:52:50	YD HDG SEL IAS	1,470	106	104			
10:53:07	YD HDG SEL PITCH HOLD	1,582	102	99			ALT not armed: Vertical Speed below 80ft/min
10:53:08	~	1,627	102	100	Two sec later, highest alt 1,661 feet (baro corrected)		
10:53:10		1,628	100	97	1 <sup>st</sup> stick shaker FO		
10:53:13	~	1,621	98	96	1 <sup>st</sup> stick shaker CAPT		CAS: 98knots
10:53:14	~	1,596	100	96	PLA2 moved forward (86 deg)		Expected to be before or at the ramp position (theoretically value is 88 deg)
10:53:17	~	1,535	101	97	1 <sup>st</sup> stick pusher		
10:53:21	HDG SEL PITCH HOLD	1,470	102	101			
10:53:24	~	1,344	107	106	CLA 1 fuel SO		ENG 1 propeller was feathered and ENG 1 was shut off
10:53:49	YD – AP HDG SEL PITCH HOLD	875	109	109			
10:53:57	YD HDG SEL PITCH HOLD	791	101	98	AP disconnection		Automatic disconnection

Local Time	Autopilot/Yaw Damper Status (AP/YD)	Radio Altitude (RALT)	Computed Airspeed (CAS)	Indicated Airspeed (IAS1)	Fact	EWD Procedure Message	Comment
10:54:08	HDG SEL PITCH HOLD	533	112	108			
10:54:14	~	544	105	98	DC essential BUS 1 voltage dropped from 28V down to 18V		ENG 1 restart request
10:54:20	~	575	96	91	CLA1 no more fuel SO		ENG 1 restart cont'd
10:54:25	~	401	106	96	NH1 reached 30% increasing		ENG 1 restart cont'd
10:54:30	~	107	110	97	PLA2 decreased down to 48 deg	After Take Off - 1EO	ATPCS disarming condition
10:54:31	~	101	108	97	ENG 2 left feather + MW ENG 2 flame out disappeared		
10:54:33							
10:54:34	~	83.5	108	100	NH1 reached 50%	ENG 1 Fire in Flight	
10:54:35.9	~	55.1	106	103	End of recording -CVR (0254:36.6 sec) ; FDR (0254:35.9 sec)		End of recorder data may contain invalid data

## 1.12 Wreckage and Impact Information

During the final stages of the occurrence flight, the aircraft's left wing collided with a motor vehicle on the Huan-Dong overpass but, with the exception of the left aileron, it remained attached to the aircraft. That wing then collided with a light pole and the overpass guard railing before the aircraft entered Keelung River in an inverted nose low attitude. The aircraft broke up on impact with the water. The aircraft wreckage was recovered and transported to the storage site for examination in 1.5 days. The salvage operation was made possible by the assistance of Central Disaster Emergency Operation, New Taipei City and Taipei City Emergency Response Centers.

### 1.12.1 Recovery of Aircraft Wreckage

The primary aircraft wreckage consisted of two major separated sections of the airframe: the cockpit section; and the middle/aft section of the fuselage. The nose of the aircraft was embedded in the mud of the riverbed. A floating bridge and three heavy lift vehicles were deployed by the Army Engineering Corps to facilitate the recovery of the deceased passengers and salvage of the aircraft wreckage. The salvage of the aircraft wreckage commenced after the search and rescue operation had recovered all surviving passengers and crew. Figure 1.12-1 depicts the initial salvage of the two major portions of the aircraft wreckage. The major portions of aircraft wreckage, including the remnants of the engines and propellers, were successfully recovered by the late afternoon of the second day of the salvage operation.



Figure 1.12-1 Wreckage recovery operations

Figures 1.12-2 and 1.12-3 identify and map the major sections and components of the aircraft that were recovered. The recovered wreckage represented approximately 85% of the whole aircraft. The remaining unrecovered 15% of the aircraft was primarily in the area aft of the cargo area and forward of the ice shield area.

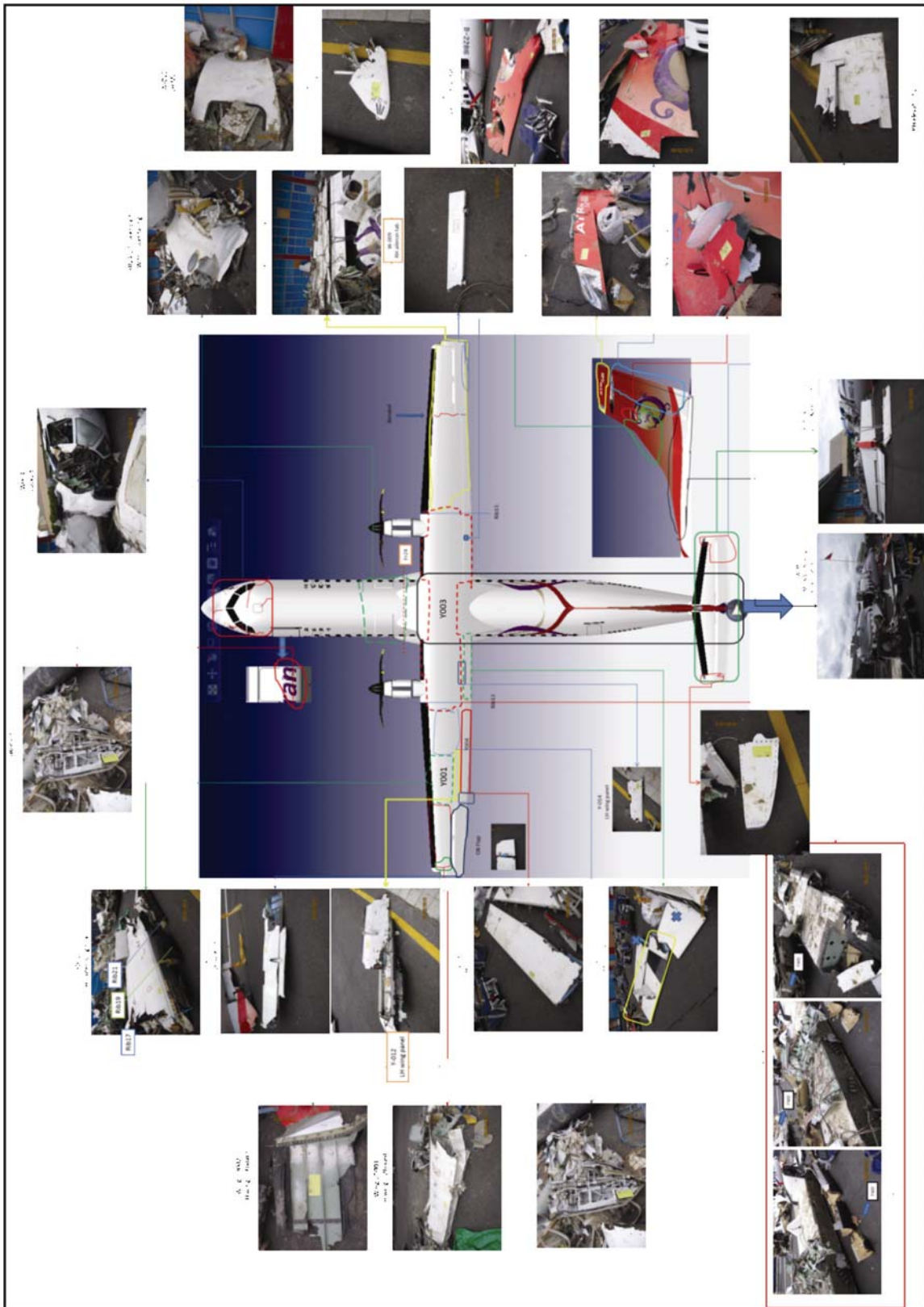

Figure 1.12-2 Recovered aircraft wreckage (1)





### 1.12.2 Wreckage Transfer and Storage

With the support of the Ministry of National Defense (MND), the recovered wreckage was transported to the Songshan Air Force Base (SAFB) for storage and subsequent examination on the evening of 5 February.

Figure 1.12-4 shows the aircraft cockpit portion being lifted and moved to the wreckage storage site. The aircraft wreckage was arranged to represent as much as possible a reconstruction of the aircraft.

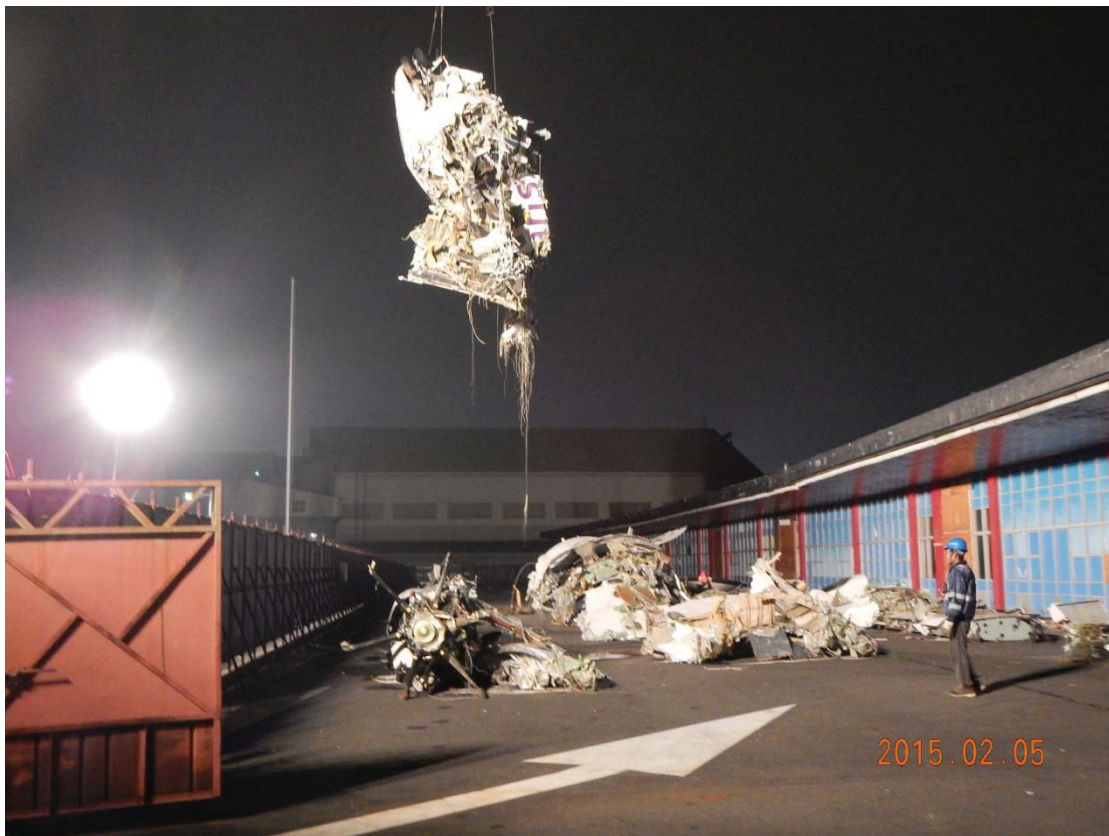

Figure 1.12-4 Wreckage storage site

### 1.12.3 Video Footage and Impact Information

Video footage and aircraft impact marks indicated that the aircraft had collided with a taxi, light pole and guard railing or barrier on the Huan-Dong overpass before impacting the Keelung River. Figure 1.12-5 presents an aerial photograph of the

accident site. Keelung River is to the north side of the overpass. The depth of the river in this location is between one to two meters.

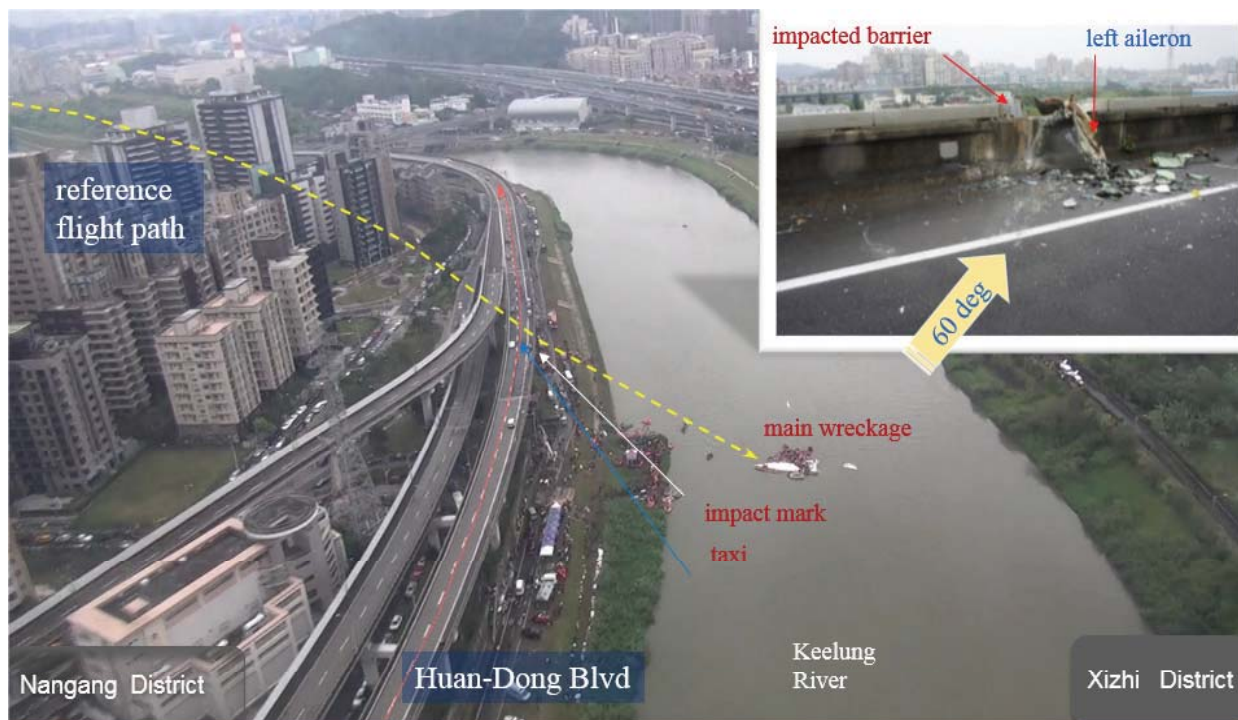

Figure 1.12-5 Aerial Photo of the GE235 crash site

The height above ground level of the Huan-Dong overpass was about 21 meters. The width of the overpass was 10 meters. An impact scar on a heading of about 060 degrees magnetic and approximately 2.5 meters long was located on the road surface. Some aircraft debris was also found near the impact point on the overpass guardrail or barrier. The aircraft also collided with a light pole, which was very close to the damaged barrier (see upper right corner of Figure 1.12-5). The distance from the impacted taxi to the damaged overpass barrier was about 9 meters and the distance from that barrier to the main wreckage in the river was about 90 meters.

The main wreckage was near inverted in the middle of the Keelung River on a heading of about 025 degrees magnetic. The primary wreckage site's reference position was N25°3'48.54", E 121°37'3.13".

Figure 1.12-6 illustrates the aircraft's final trajectory and impact location. The

image utilized the FDR derived flight path superimposed on related satellite imagery and ground building models generated from the digital terrain data and aerial photos provided by Taipei City Government's Department of Urban Development. Figure 1.12-7 presents an aerial photo of the accident site taken from a rescue helicopter.

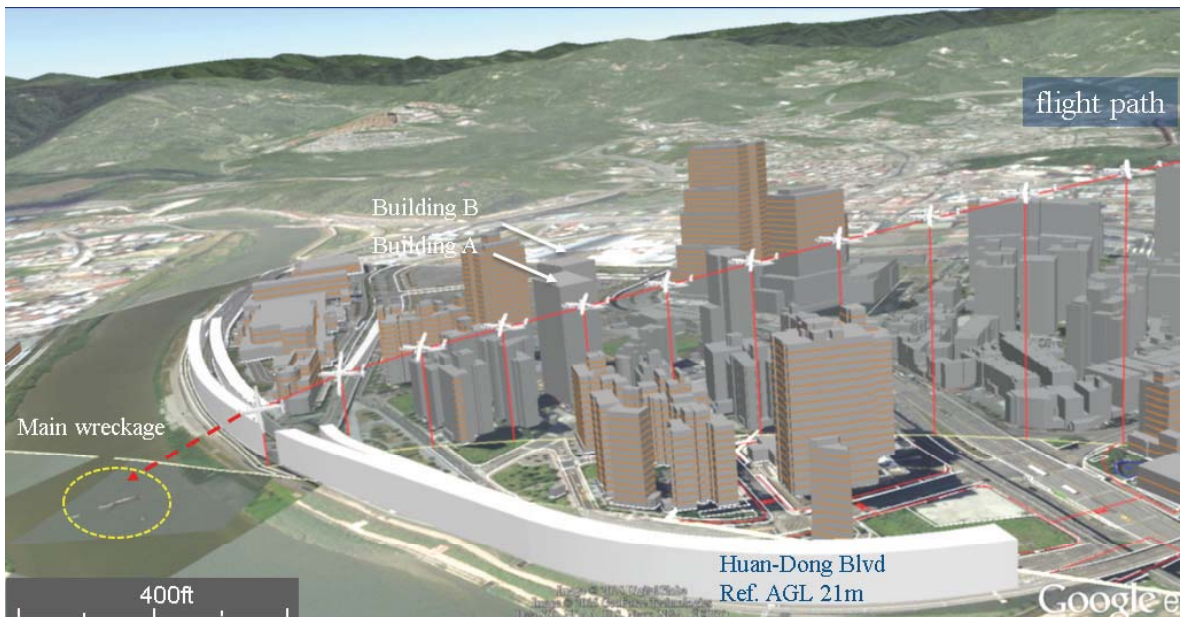

Figure 1.12-6 Aircraft's final trajectory and impact location

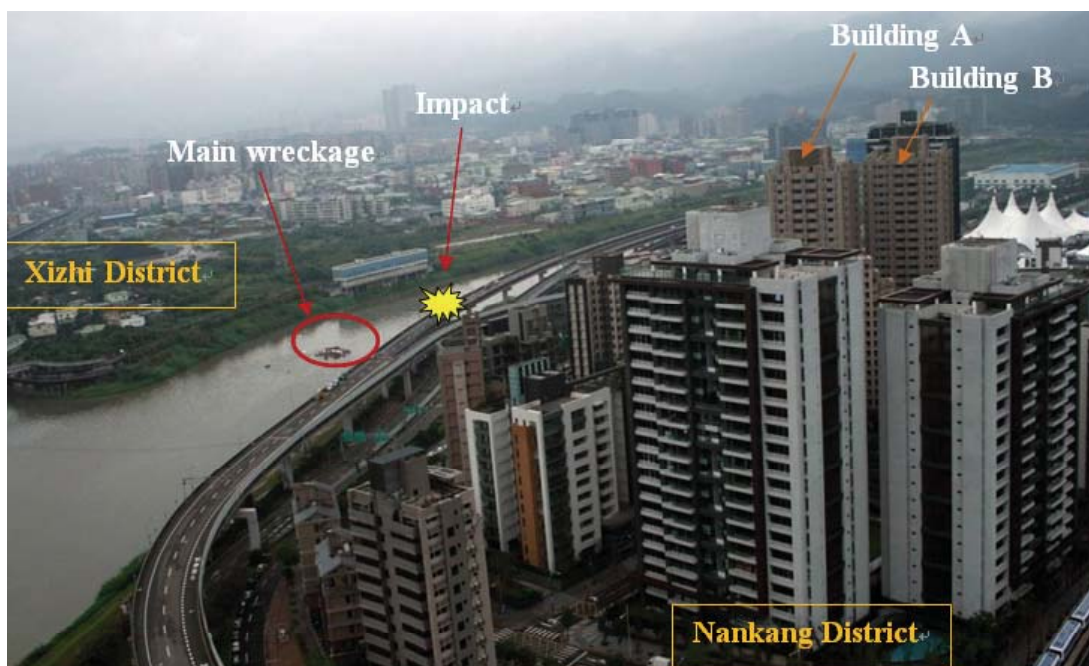

Figure 1.12-7 Aerial photo of occurrence site taken from a rescue helicopter

### **1.12.3.1 Video Footage of the Occurrence**

The aircraft's flight path was filmed by various sources including motor vehicle dashboard video and building security cameras. A motor vehicle traveling westbound on Huan-Dong overpass captured clear footage of the occurrence. The video footage and data from the onboard recorders were synchronized using the probable sound of impact with the taxi and overpass heard on the CVR and captured by the motor vehicle's dashboard camera at 1054:34.8. Relevant video snapshots of the aircraft from the car's dashboard camera have been annotated with CVR times and are shown in Figure 1.12-8<sup>34</sup>.

The video frame rate of the vehicles dashboard camera was 25 frames per second, which meant that a frame was equal to 0.04 seconds. Figures 1.12-9 to Figure 1.12-11 present the dashboard camera video images of the aircraft's the final trajectory. In conjunction with the site survey data, the aircraft banked to the left at about 90 degrees as it collided with the taxi on the overpass. The estimated distance between the taxi and the overpass barrier was about 9 meters. Figure 1.12-11 indicated that the aircraft impacted the northern barrier of the Huan-Dong overpass at 1107:07 on the video, which corresponded to a CVR time of 1054:34.76.

---

<sup>34</sup> Use of the video was authorized by the TVBS.



Figure 1.12-8 Snapshots extracted from the motor vehicle's dashboard camera



Figure 1.12-9 14<sup>th</sup> frame of dashboard camera video



Figure 1.12-10 17<sup>th</sup> frame of dashboard camera video



Figure 1.12-11 19<sup>th</sup> frame of dashboard camera video

## 1.13 Medical and Pathological Information

### 1.13.1 Medical Treatment of Surviving Passengers

Thirteen of the 14 passengers and one cabin crew who survived the accident sustained serious injuries as a result of impact forces. The injuries included head trauma, fractures, bruising, abrasions and lacerations. One passenger sustained minor injuries. The surviving passengers were initially transported to six local hospitals around Taipei City and New Taipei City for treatment.

### **1.13.2 Flight Crew Toxicology Information**

The Institute of Forensic Medicine (IFM), Ministry of Justice, conducted toxicology examinations of the three flight crew members. The test items included alcohol content, poisons, sedatives, hypnotics, carbon monoxide hemoglobin and the basic drugs screen (about one thousand items).

Captain A's toxicology report of indicated no evidence of drugs or toxins.

Captain B's toxicology report indicated doxycycline<sup>35</sup> in the blood and urine. No other drugs or toxins were found.

The First Officer's toxicology report indicated amlodipine<sup>36</sup> in the blood and urine. No other drugs or toxins were found.

### **1.13.3 Flight Crew Autopsies**

The forensic pathologists from the IFM performed the autopsies of the three flight crew members. The autopsy reports indicated that the cause of death for the three flight crew was the same. They had suffered multiple fatal head injuries.

### **1.13.4 Victim Inspections**

The inspections conducted by the IFM indicated that the primary causes of death were multiple traumatic injuries and drowning.

---

<sup>35</sup> Doxycycline is used to treat bacterial infections. It is in a class of medications called tetracycline antibiotics. It works by preventing the growth and spread of bacteria. (U.S. National Library of Medicine <https://www.nlm.nih.gov/medlineplus/druginfo/meds/a682063.html>)

<sup>36</sup> Amlodipine: A calcium channel blocker heart medication used in the treatment of hypertension. (U.S. Federal Aeronautical Administration <http://jag.cami.jcabi.gov/toxicology/DrugDetail.asp?did=128>)



## 1.14 Fire

Not applicable.

## 1.15 Survival Aspects

TransAsia's ATR72-600 was configured with 72 economy class passenger seats. There were two pilot seats and one observer seat in the cockpit and two cabin crew seats at the front and rear of the cabin

Figure 1.15-1 illustrates the cabin configuration with the passenger and crew injury and fatality distribution. The passenger seating positions were based on the airline seating plan and interviews with the surviving passengers.

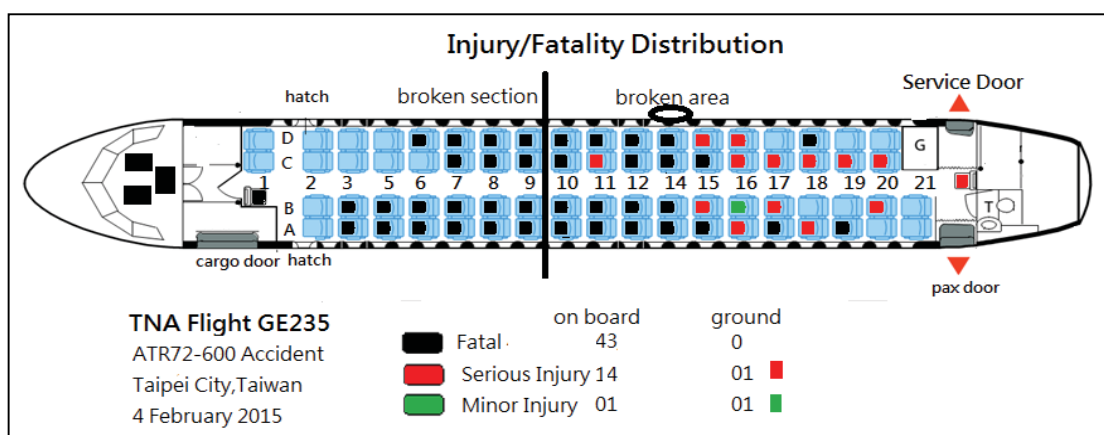

Figure 1.15-1 Injury and fatality distribution

### 1.15.1 Emergency Escape

All of the 15 survivors were seated after row 10. The surviving passengers and crew reported that after the aircraft impacted the water, the middle-aft section of the fuselage separated from the aircraft and rotated counterclockwise in an inverted position. The cabin environment became dark and was inundated by fuel odor. Some of passengers were rendered unconscious immediately after impact and were upside down in the cabin restrained by their seatbelts. It was reported that the unconscious passengers then regained consciousness as they began to choke on the water that was engulfing the cabin. Most survivors were still in their seats and unbuckled their seat

belts by themselves or were assisted by other passengers.

There was a break or breach in the right side of the aircraft's fuselage around rows 14 to 15. The survivors reported that they saw light from outside through this opening and they then decided to egress the aircraft via that opening. There were some objects obstructing the survivors' escape path including seats, luggage, and other debris. One survivor who had escaped through that opening reported that her watch showed 1105 at that time. She tried to bang on the service door but failed during her escaped process. A total of 10 survivors escaped from this break in the fuselage and then stood on the aircraft wing awaiting rescue.

There were five survivors seated closest to aft-cabin escaped from the service door. One of the five survivors tried to comfort and took care of other 4 survivors when waiting for rescue and he tried to knock on the window for help. The rescuers opened the service door and rescued these five passengers at around 1135 through the service door.

### **1.15.2 Rescue**

According to interviews with the rescuers and the official rescue report, the first nine rescue vehicles, with about 15 fire fighters from Taipei City and New Taipei City, rushed to the crash site from about 1105 to 1115 after receiving notification from the firefighting command centers. Three of the fire fighters tried to swim to the aircraft main wreckage in the river. Two of them failed to reach the aircraft because of the strong current. Two powered rubber boats finally reached the aircraft main wreckage area at 1130 and began to rescue the group of 10 survivors who were standing on a wing section. The other rescuers then opened the service door near the aircraft's tail section and rescued the five survivors trapped in that area.

The cabin was dark and inundated with fuel odor when the rescuers entered the cabin. They used explosion-proof lights and hydraulic cutters to help rescue the survivors. TransAsia maintenance staff and the fire fighters from Taipei's Songshan

Airport provided information regarding the location of the aircraft's exits, door operation, fuel tank position, cutting areas, hanging points and so on. Most of the deceased persons in the cabin were sitting in their seats with their seat belts fastened suspended upside down immersed in water.

## **1.16 Tests and Research**

### **1.16.1 TNA Simulator Training Observation**

The investigation team conducted an observation of TNA's ATR72-600 annual proficiency training and proficiency checking (PT/PC) in May 2015 at Bangkok Airways training center. Six simulator sessions were observed. Of the six sessions, four comprised PT and two comprised PC. The crew pairing included a captain and FO as the PF and PM respectively for each session. The training was conducted by an instructor/check pilot (IP/CP).

The investigators noted the following: the ATPCS test was not performed during the sessions (including the PC sessions); the take off briefing covered single engine procedures and the acceleration altitude; and the flight crew conducted the ATPCS callout "ARM" during the aircraft's take off roll. The PF was responsible for the power levers (PL) and the PM was responsible for the condition levers (CL) during the single engine flameout sequence; however, the PF operated both the PL and CL for a simulated engine fire during takeoff and an emergency descent sequence.

### **1.16.2 Simulation Testing**

To further understand the technical and pilot performance issues in the occurrence, two ATR72-600 simulator sessions were conducted at the ATR full flight simulator<sup>37</sup> (FFS) facility in Toulouse, France from 27 to 28 July 2015.

The simulated flights replicated the time of day, weather conditions, and aircraft

---

<sup>37</sup> The FFS are designed and certified for training purposes based on mandatory items defined by the respective certification authorities.

weight and balance at the time of the occurrence.

The two simulator sessions comprised a total of four hours of testing. Two of the aircraft manufacturer's current and experienced ATR72-600 type-rated pilots, which included a test pilot and an instructor/training examiner pilot, conducted the simulated test flights. The simulated test flights were observed by members of the investigations flight operations group and included representatives from the ASC, BEA and ATR.

The findings from the simulated test flights included:

- The occurrence profile was successfully reproduced.
- While flying the occurrence profile, the pilot workload was considered light<sup>38</sup> before the stall warning (audio stall warning and stick shaker). The workload was medium to high after the stall warning.
- The ATR flight crew conducting the test had no difficulties handling the single engine flameout situation as long as they followed the abnormal procedures published in the ATR flight crew operating manual. The tests were conducted with and without the autopilot (AP) engaged, with the same results in both cases.
- The execution of the single engine flameout after takeoff with the ATPCS armed demonstrated that the AP did not automatically disengage. The simulated aircraft maintained wings level flight as expected and continued the climb at around 600 feet per minute (fpm) at an indicated airspeed of 115 knots<sup>39</sup>.

---

<sup>38</sup> The simulated session was prepared to be as much representative as possible of the occurrence flight so that the simulation test flight crew performed the same actions as the occurrence flight crew. The evaluation of the workload was conducted by the simulation test flight crew (composed by one ATR training captain and one ATR test pilot) who have respectively 20 and 19 years of experience in evaluating flight performance in simulated flights.

<sup>39</sup> V2 or the take off safety speed in normal conditions at MTOW is 115 knots. V2 is the minimum speed that needs to be maintained up to the acceleration altitude, in the event of an engine failure after V1. Flight at V2 ensures that the minimum climb gradient required is achieved, and that the aircraft is controllable ( $V2 \geq 1.13$  VSR and  $V2 \geq 1.1$  VMCA). Note. V1 is the decision speed, the maximum speed at which a rejected take off can be initiated by the pilot, and the minimum speed at which the take off can be continued in the event of an engine failure. If an engine failure does occur after V1 the take off should be continued. VSR is the reference stall speed. VMCA is the calibrated airspeed at which, when an engine fails or is inoperative, it is possible to maintain straight flight only, provided a small bank angle of 5° is maintained away from the inoperative engine with RTO power set on the operative engine (take off flaps setting and gear retracted).

- The execution of the single engine flameout after takeoff with the ATPCS selected ‘OFF’ demonstrated a reduction in aircraft performance because there was no uptrim (engine power increase) on the operative engine or autofeather of the failed engine. The simulated aircraft maintained wings level flight and continued the climb between 100 to 300 FPM at an indicated airspeed of 115 knots. This exercise was performed without applying the full ATPCS OFF dispatch conditions according to MMEL.
- The AP was effective in controlling the aircraft during a single engine flameout. It ensured that the aircraft maintained the required profile. A series of autopilot disconnection tests were conducted to assess the behavior of the aircraft. The first autopilot disconnection test was performed with a rudder input of more than 30daN<sup>40</sup> which was the force required to disconnect the yaw damper (YD) and AP. After the disconnection of the YD and the AP, the test flight crew did not apply any control inputs for a few seconds to enable the observers the time to view the aircraft’s behavior without pilot inputs. The aircraft’s behavior was consistent with a twin-engine aircraft type flying with asymmetric thrust and no pilot control inputs: it yawed and rolled towards the failed engine obtaining approximately 20 degrees of roll in a few seconds. It took the flight crew four seconds to revert to wings level. During the other AP disconnection test, the AP was disengaged using the disconnect push button but the YD remained engaged. The bank angle change was about 8 degrees. The yaw auto trim function compensated for the yaw deviation.
- There were no manual aircraft control difficulties experienced in the single engine condition with airspeeds between 95 and 118 knots. The simulated aircraft response was a little sluggish and the stall warning activated intermittently during low speed flight.

---

<sup>40</sup> A decanewton (daN) is a unit of force equal to 10 newtons. One newton is the force needed to accelerate one kilogram of mass at the rate of one metre per second squared.

- The stall test results showed that the stick shaker and stick pusher worked as designed. It took approximately 10 seconds and 400 feet of altitude to recover the simulated aircraft from stick pusher activation at 93 knots until the aircraft acquired 118 knots. If the stall recovery maneuver was conducted immediately after stick shaker activation at 99 knots, it took the test crew approximately 6 seconds and less than 100 feet of altitude to recover the aircraft and increase the airspeed to 118 knots. There is another phenomenon has been observed in the stall test; as the FMA vertical mode had previously reverted to “PITCH HOLD” mode, the flight director (FD) bars provided guidance to maintain a pitch target of 8°. When the stick shaker and subsequently the stick pusher activated the aircraft pitch was consequently decreased to approximately 10° nose-down while the FD bars were still showing a nose-up guidance on the primary flight display (PFD) according to the “PITCH HOLD” mode.(Ref Fig. 1.16-1)
- The occurrence flight crew unsuccessfully attempted to restart the operative engine late in the descent. A simulated engine air restart test was conducted to determine the parameters for success. The air restart was initiated at an altitude of 1,400 feet above ground level. The time required to successfully restart the engine was approximately 25 to 30 seconds after the start procedure was initiated. Several simulated air restart tests were performed and the aircraft lost between 400 to 900 feet of altitude, which indicated that it was highly unlikely that the occurrence flight crew would have been able to successfully restart the operative engine with the altitude they had remaining.



Figure 1.16-1 PFD display while the stick pusher activated

### 1.16.3 Aircraft Structure Examination

The examination of the aircraft structure was conducted on 10 February 2015 at the SAFB wreckage storage site. The examination was conducted by ASC, CAA, and TNA structural engineers. Seven major aircraft structural components were examined. The fracture surfaces of the structural components were consistent with overload and post impact damage.

### 1.16.4 Engine Examination

The examination of the aircraft engines was conducted from 7 February to 9 February 2015 at the SAFB wreckage storage site. Representatives from the

Transportation Safety Board (TSB) Canada, Transport Canada (TC), ATR, P&WC, CAA, TNA and ASC participated in the examination.

#### **1.16.4.1 Engine Number 1**

The ENG 1 was examined in the airframe nacelle as recovered. The external case inspection revealed that all quick engine change items and airframe nacelle to engine connections appeared to be intact, with water immersion damage. The propeller blade remained attached to the hub with the blade outer spans separated.

The engine turbo machine was borescope inspected in accordance with the PW127 engine maintenance manual. The turbine section components, combustion section components, compressor section components and reduction gearbox components all displayed no indications of any anomalies affecting normal operation, and all components observed showed normal running wear. All components showed immersion damage.

Some control and accessory components of ENG 1 were removed and shipped to TSB Canada for dispatch to their respective vendors for investigation and analysis under the oversight of the U.S. National Transportation Safety Board (NTSB), Transport Canada (TC), BEA, P&WC, ATR, UTC Aerospace Systems (UTAS) and ASC. The removed components included the following: propeller electronic control (PEC), engine electronic control (EEC), auto feather unit (AFU), data collection unit (DCU), torque sensor No. 1 and No. 2, upper and lower high rotor speed (Nh) sensors, low rotor speed (Nl) sensor and propeller speed (Np) sensor.

#### **1.16.4.2 Engine Number 2**

The ENG 2 was examined in the airframe nacelle as recovered. The external case inspection revealed that all quick engine change items and airframe nacelle to engine connections appeared to be intact, with water immersion damage. The propeller blade remained attached to the hub with the blade outer spans separated. The nacelle aft section and exhaust duct were separated.



The engine turbo machine was borescope inspected in accordance with the PW127 engine maintenance manual. The turbine section components, combustion section components, compressor section components and reduction gearbox components all displayed no indications of any anomalies affecting normal operation, and all components observed showed normal running wear. All components showed immersion damage.

To troubleshoot the technical factors that contributed to the uncommanded autofeather, a continuity check of the AFU harness, which connected the AFU and No.1 torque sensor, was undertaken. According to the PW127 engine maintenance manual, all the results were within limits (see Table 1.16-1 and Figure 1.16-2). Upon removal of the harness plugs for the continuity check, both the torque probe and AFU plugs showed slight water ingress to the plug retaining collar. The connector pin seats appeared to be dry.

Table 1.16-1 Continuity check of AFU No. 2 electrical circuit

Point-A	Point-B	Expected	Result
J6 pin A	J6 pin B	553-589 ohms	575 ohms
P16 pin H	P6 pin A	0-0.5 ohms	0 ohm
P16 pin J	P6 pin B	0-0.5 ohms	0 ohm
Insulation resistance (with reference to ground) of torque sensor No. 1 > 2 Mohms			

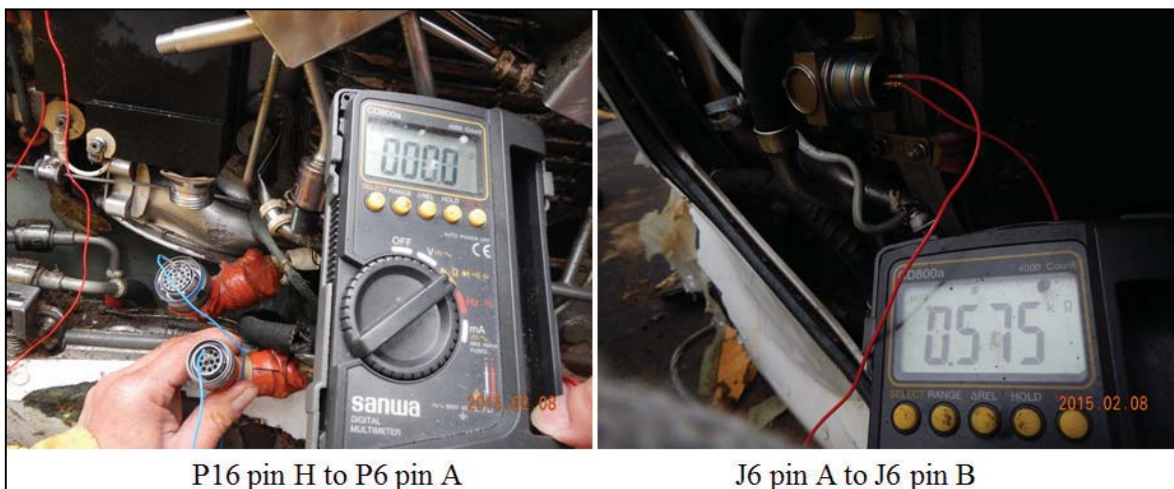

Figure 1.16-2 Continuity check of AFU No. 2 electrical circuit

Some ENG 2 control and accessory components were removed and shipped to TSB Canada for dispatch to their respective vendors for investigation and analysis under the oversight of the NTSB, TC, BEA, P&WC, ATR, UTAS and ASC. The removed components included the following: PEC, EEC, AFU, DCU, Torque Sensor No. 1 and No. 2, upper and lower Nh Sensors, Nl sensor and Np sensor.

## **1.16.5 Components Test and Examination<sup>41</sup>**

### **1.16.5.1 Auto Feather Units Testing**

The occurrence aircraft's two auto feather units (AFUs) were removed and sent to the manufacturer (UTAS) in the USA for examination and testing. In addition, another AFU from another ATR72 aircraft that had experienced an uncommanded autofeather event<sup>42</sup> after the GE235 occurrence was also sent to the manufacturer for examination and testing.

The testing was performed at the UTAS facility in Eagan/Burnsville, Minnesota, USA, from 8 to 11 April 2015. Representatives from the involved safety investigation boards (NTSB, BEA and ASC), state of engine manufacturer's civil aviation regulatory authority (Transport Canada), aircraft and engine technical advisors (UTAS, PWC and ATR) and observers from TransAsia Airways attended the AFU examination and testing. The testing included standard functional testing (shop test) and detailed laboratory examination. The NTSB representative documented key findings and group decisions during the shop test with a field notes. The BEA also prepared a Meeting Report of the AFUs testing (Document no. BEA2015-0039\_tec10). The Meeting Report detailed the shop test process and results but did not include the laboratory examination. After the completion of the AFUs examination and test, the NTSB provided ASC a comprehensive AFU Investigation Report prepared by UTAS on 11

---



<sup>41</sup> All the tests were conducted on components post-impact.

<sup>42</sup> A TransAsia flight GE507, ATR72-500, B-22806, encountered an uncommanded autofeather event on 21 February 2015.

June 2015. The following information presents relevant excerpts from these technical reports regarding the status of the three AFUs.

**Basic information:** Basic information for the three AFUs is shown in Table 1.16-2.

Table 1.16-2 AFUs basic information

	AFU No.1	AFU No.2	AFU No.3
			
<b>Manufacturer</b>	UTAS	UTAS	UTAS
<b>Part Number</b>	30048-0000-28	30048-0000-28	30048-0000-28
<b>Serial Number</b>	RT3077	RT2362	RT2354
<b>J2 Connector Reference *</b>	1301	1315	1315
<b>Position</b>	Engine number 1	Engine number 2	Engine number 1
<b>Aircraft ID</b>	B-22816	B-22816	B-22806
<b>Flight ID</b>	GE 235	GE 235	GE 507
<b>TSN<sup>43</sup></b>	826	1,624	1,206
<b>CSN<sup>44</sup></b>	1,236	2,352	1,723
* Format is year week (YYWW)			

**Terms of reference for AFU testing**

The following testing protocol for each AFU was agreed to all the units before the meeting:

<sup>43</sup> Time since new.  
<sup>44</sup> Cycle since new.

- Visual inspection;
- Perform a continuity check;<sup>45</sup>
- Perform the functional tests manually;
- Perform the functional tests automatically;<sup>46</sup>
- Perform the thermal cycle tests; and
- Perform the vibrations tests.

If a device failed a test, then the testing protocol would be modified or adapted to facilitate alternative instructive testing.

### **AFU No. 1**

AFU No. 1 passed the continuity test, manual functional tests, automatic functional tests, thermal tests and vibration tests.

### **Findings for AFU No. 1**

- AFU No. 1 passed all the tests in accordance with the component maintenance manual (CMM).

### **AFU No. 2**

AFU No. 2 failed to pass the continuity test. The measured resistance values for connector pins J and H<sup>47</sup> fluctuated from 1 to 20 ohms when the ribbon was moved by hand. The resistance was higher than the CMM<sup>48</sup> values threshold of 0.35 ohms for pins J and H. These two pins connected to the torque sensor. An X-ray examination of AFU No. 2 was performed and no defect was found. In order to identify the source of the increased resistance between J2 connector pins J/H and the A2 board strip contact

---

<sup>45</sup> 73-20-03 Rev11, Component Maintenance Manual, Part Number 30048-0000-\* Part Testing and Fault Isolation. More details on the continuity, functional, thermal cycle and vibration testing process can be found in the Component Maintenance Manual pp.101-129.

<sup>46</sup> D06409502 Rev C, acceptance test procedure.

<sup>47</sup> The J2 connector pins J and H are part of the AFU connector that connects the AFU to the torque sensor through the ribbon wire. Continuity of the signal is required to ensure the functionality of ATPCS. A disrupted signal may result in an uncommanded autofeather).

<sup>48</sup> Component maintenance manual with Illustrated Parts List, 73-20-03, Rev. 11, 1 Oct 2014.

(contact points No. 34/33), a new test procedure for assessing AFU No. 2 was proposed and agreed to by all attendees.

Three test points were defined to isolate the source of high resistance:

- X1 – The insulation was removed at the end of the flex circuit to create a testing point.
- X2 – The flange on the pin that was soldered between the flex circuit and the circuit card.
- X3 – A testing point on the circuit card, instead of the strip contact point defined in the CMM.

With reference to Figure 1.16-3, the test results found that:

- The resistance ( $R_{X1}$ ) measured between pin J and point X1 provided a value consistent with the maximum resistance value provided by the CMM. Moving the ribbon did not affect this value.
- The resistance ( $R_{X2}$ ) measured between pin J and point X2 provided a value greater than  $R_{X1}$ , which was unstable and changed while the ribbon was moved.
- The resistance ( $R_{X3}$ ) measured between pin J and point X3 provided a value greater than  $R_{X1}$ , which was unstable and changed while the ribbon was moved.

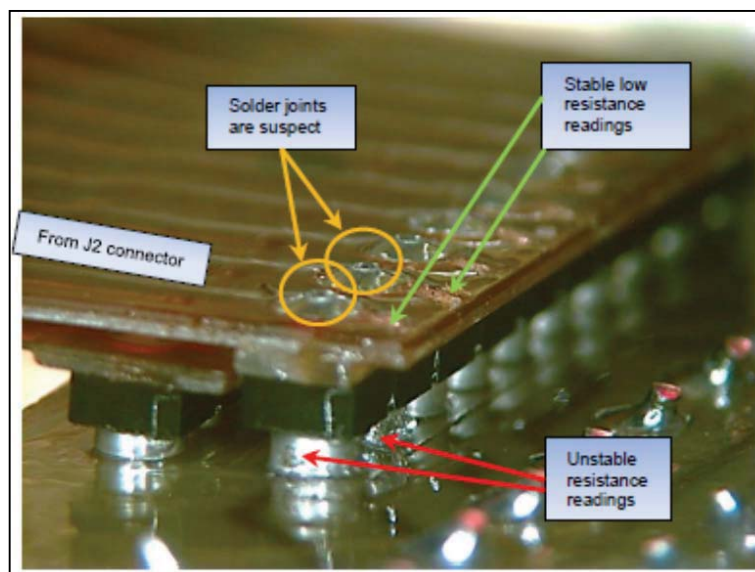

Figure 1.16-3 Continuity check of pin J and A2 board

It was noted that the first time  $R_{J2}$  and  $R_{H2}$  were measured, both were unstable. Repeated resistance testing of pins J and H resulted in only one stable result for  $R_{J2}$  and/or  $R_{H2}$ . The continuity failures detected on pins H and J were located inside the header strip connector (end of the ribbon, opposite the J2 socket). The discontinuity was observed to be intermittent. The test results with the new test procedure are summarized in Table 1.16-3.

Table 1.16-3 AFU No. 2 J2 connector pins J and H resistance test results

AFU No. 2	Resistance		
J2 Connector Pin	X1	X2	X3
Pin J	Stable	Unstable	Unstable
Pin H	Stable	Unstable	Unstable

The AFU No. 2 functional test was not completed because of a short circuit during the gain test. An X-ray examination was conducted and a possible cause was identified as bonding No. 16 of component U5 on the A2 board. As component replacement could be seen as a destructive choice, it was decided to stop the test of this unit.

A CT-Scan (computed tomography) of the J2 solder joints was subsequently performed and potential solder cracking was identified. A destructive test was performed to find the possible root cause of continuity failures inside the J2 flex circuit 90 connector. The J2 flex circuit was cut out of the circuit card assembly (CCA) and housing. J2 flex circuit pins 33-42 were examined using an optical microscope and a scanning electron microscope (SEM). Figure 1.16-4 shows the microscope (40X magnification) and SEM images for Pins 33 and 34. The J2 flex circuit connector pins 33-42 were cross sectioned to the component centerline and examined. Figures 1.16-5 and 1.16-6 show the cross sectioned pin to flex solder joints of pins 33 and 34. In the optical cross-section images the lead-rich area was indicated by the grey particles dispersed within the white tin-rich area. In the SEM images the lead area is represented by white and tin by grey. The pin-flex solder joints displayed a coursing of the solder

micro structure near the pin on each of the 10 pins in the strip. The condition was most advanced on pins near the end of the strip. The solder microstructure was consistent with enlargement, coarsening and cracking in a stress zone adjacent to the pin/solder interface. Away from this “stress zone” the solder microstructure was very fine.

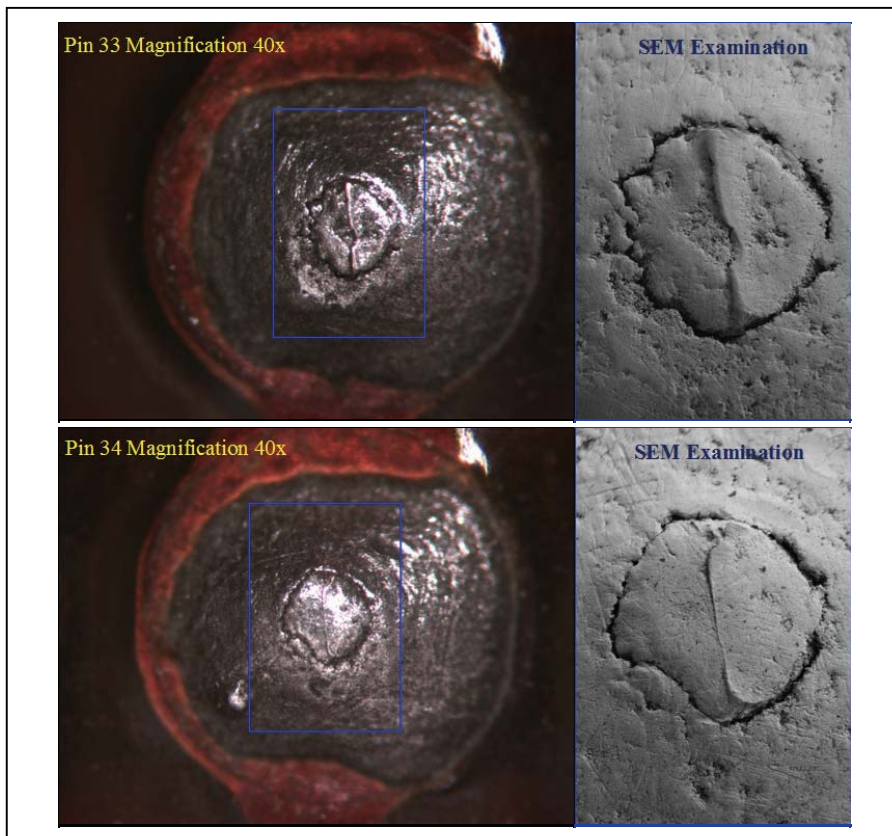

Figure 1.16-4 Microscope (40X magnification) and SEM images for Pins 33 and 34.

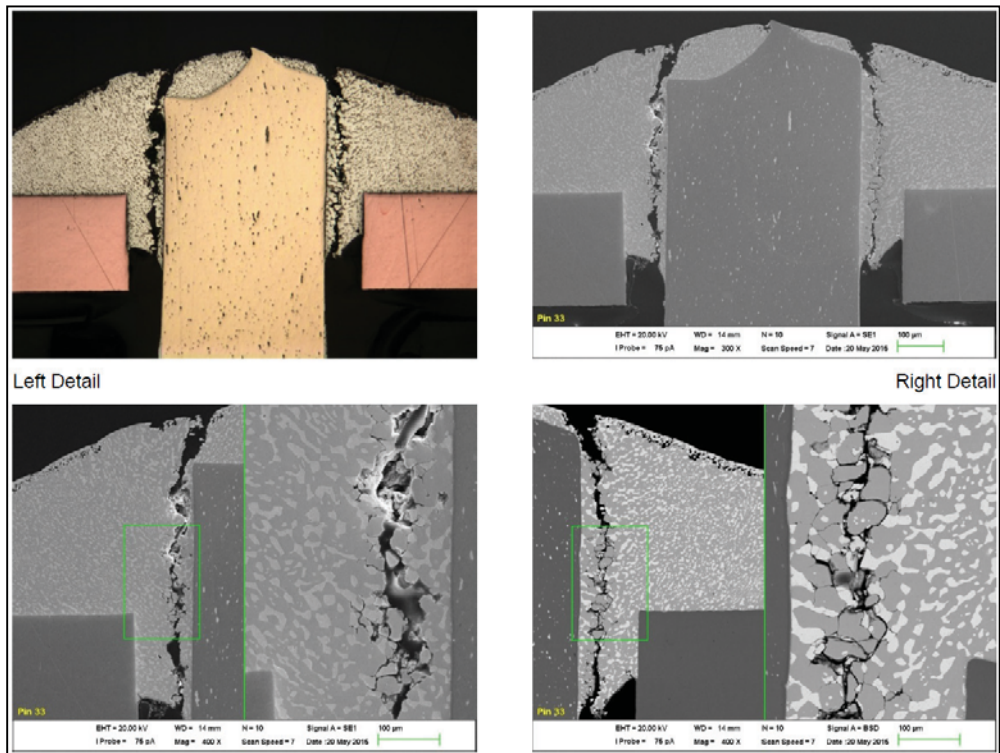

Figure 1.16-5 Cross sectioned pin to flex solder joints of pins 33

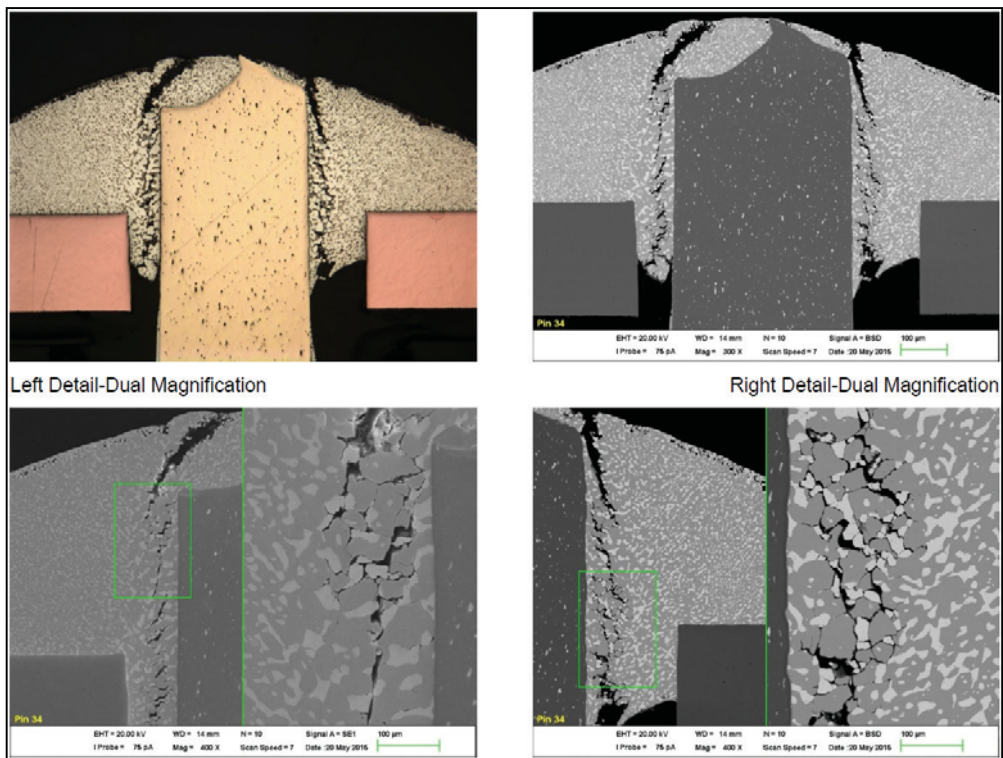

Figure 1.16-6 Cross sectioned pin to flex solder joints of pins 34



## **Summary of Findings for AFU No. 2**

- Continuity failures (resistance values above the CMM threshold) existed between J2 connector pin H and the circuit board, and between pin J and the circuit board;
- Continuity failures (resistance values above the CMM threshold) were located at the solder joint interface between the J2 flex circuit and the header pin;
- Continuity failures (resistance values above the CMM threshold) were intermittent; and
- The solder microstructure was consistent with enlargement, coarsening and cracking in a stress zone adjacent to the solder joint interface between the flex circuit and the header pin.

## **AFU No. 3**

Only J2 connector pin J failed the AFU No. 3 continuity test. The measured resistance value for connector pin J fluctuated between 1 and 10 ohms when the ribbon was moved by hand. The resistance was higher than the CMM value threshold of 0.35 ohms for pin J. An X-ray examination of AFU No. 3 identified no defects. In order to identify the source of the continuity failure between J2 connector pin J and the A2 board strip contact (contact point No. 34), the same new test procedure that was developed for AFU No. 2 was applied to AFU No. 3. The definitions of test points X1, X2 and X3, were the same as those for AFU No. 2.

The tested resistance values ( $R_{X1}$ ,  $R_{X2}$ ,  $R_{X3}$ ) for AFU No. 3 were similar to those of AFU No. 2 except that the resistance values  $R_{X2}$  were all repeatedly unstable during the testing. The continuity failure detected on pin J was located inside the header strip connector (end of the ribbon, opposite the J2 socket). The test results with the new test procedure are summarized in Table 1.16-4.

Table 1.16-4 AFU No. 3 J2 connector pin J resistance test results

AFU No. 3	Resistance		
J2 Connector Pin	X1	X2	X3
Pin J	Stable	Unstable	Unstable

A CT-Scan of the J2 solder joints was subsequently performed and potential solder cracking was identified. A destructive test was to find the possible root cause of continuity failures inside the J2 flex circuit 90 connector. The J2 flex circuit was cut out of the CCA and housing. J2 flex circuit pins 33-42 were examined using an optical microscope and a SEM. The J2 flex circuit connector pins 33-42 were cross sectioned to a shallow depth (20%) and examined. The process was repeated to the component centerline. The pin-flex solder joints displayed a coarsening of the solder micro structure near the pin on each of the 10 pins in the strip. The condition was most advanced on pins near the end of the strip. The solder microstructure was consistent with enlargement, coarsening and cracking in a stress zone adjacent to the pin/solder interface. Away from this “stress zone” the solder microstructure was very fine.

### **Summary of Findings for AFU No. 3**

- Continuity failures (resistance values above the CMM threshold) existed between J2 connector pin J and the circuit board;
- Continuity failures (resistance values above the CMM threshold) were located at the solder joint interface between the J2 flex circuit and the header pin;
- The solder microstructure was consistent with enlargement, coarsening and cracking in a stress zone adjacent the solder joint interface between the flex circuit and the header pin;
- Functional tests were passed despite the continuity failure (resistance values above the CMM threshold); and
- Thermal cycles’ tests were passed despite the continuity failure (resistance values above the CMM threshold).

### **Further simulation of AFU performance with increased inline resistance**

In an effort to understand the potential impact of increased resistance between the torque sensor and the AFU the system was modeled and simulated. UTAS performed the simulation with the information required to model the torque probe provided by P&WC. The AFU model was reduced to the zero crossing circuit which is the 1st signal conditioning circuit block used to convert the torque probe signal to voltage level. Between the models a resistance was added to represent the resistance between the torque probe and the AFU circuit card. The findings of this simulation are:

- The simulation and bench testing indicated that AFU performance would be impacted at 10k to 25k ohms.
- The AFU was not able to receive adequate signal levels when the resistance reached 35k to 50k ohms.

#### **1.16.5.2 MFCs NVM Data Download**

Twenty two circuit boards from the occurrence aircraft's two multi function computers (MFC 1, 2) were removed and dispatched to the BEA for non-volatile memory (NVM) data download and readout.

Four memory chips were extracted from the central processing units (CPUs) of MFC 1 and MFC 2. The chips were dried and electrically checked before the data download and readout commenced. The data were readout twice to confirm the accuracy of the downloaded binary files. The binary data files were decoded by the BEA and Airbus. The results were the same. Information stored in the memory chips was divided into three groups: Basic BITE<sup>49</sup>; Advanced BITE; and Super advanced BITE.

The results of the readout indicated a code 02 failure (flight controls) was recorded in the Basic BITE. No other failure had been detected since the last MFC

---

<sup>49</sup> BITE: built-in test equipment. BITE provides an integrated ground maintenance/in-flight maintenance monitoring system that is available to maintenance personnel whenever power is applied to the aircraft. The system design objectives are to minimize on-aircraft maintenance time, reduce unconfirmed line replaceable unit (LRU) removal rates, and facilitate identification of failed LRUs and associated interfaces.

maintenance action<sup>50</sup>.

Advanced BITE provided technical information on the aircraft's last 8 flights before the occurrence, with the exception of the two flights immediately preceding the occurrence flight. Six of the most recent flights contained the code 02 failure. The definition of a code 02 failure and the associated corrective actions were:

- TORQUE 2 FAULT (confirmation delay: 30 s)
- This code appears with the following conditions:
  - Right power lever in TO position AND torque below 25%
  - OR Right power lever not in TO position AND torque upper 50%
  - AND Right ECU not fault
  - AND Right engine oil not in low pressure
  - AND MFC1B or 2B valid
- Maintenance Actions:
  - Check AFU, Torque indicator, microswitch on right power lever and associated wiring.

When a code 02 failure occurs, the origin of the failure may be in any of the signal from: TQ sensor #1<sup>51</sup> of ENG 2, the harness or AFU No. 2 (S/N: RT2362). This failure will affect the torque indication on EWD, flight crew may see the ENG 2 torque analog indication fluctuated.

The last two flights prior to the occurrence flight were performed on the same day of the occurrence flight (4 February 2015). There was no failure code for those flights recorded in the memory chips.

---

<sup>50</sup> TNA information: TNA checks MFC memory every Wednesday night during the aircraft's weekly check. If the only failure code presented was WOW (weight on wheels), the memory was erased. If there were failure codes other than WOW, the associated corrective actions were documented in the technical log book (TLB). The airline's maintenance records indicated that the occurrence aircraft's most recent weekly check was performed on 28 January 2015 with no faults found.

<sup>51</sup> The TQ sensor #1 supplies the analog torque indication displayed on the EWD. If the analog torque indication had failed before the occurrence, the failure would probably have had an influence on the information displayed to the crew; The TQ sensor #2 supplies the digital torque indication displayed on the EWD. The DFDR records the torque value supplied by the TQ sensor #2.

During the occurrence flight, MFC #2 recorded an autofeather request inside the super advanced BITE, with a signal coming from AFU No. 2. Both module 2A and 2B recorded the same context:

- A single record
- Code E1: Activation signal for feathering pump 2 status
- Code E3: Auto feathering signal from AFU No. 2

This recording was consistent with the code 02 failure (flight controls), recorded inside the basic BITE during the occurrence flight (all the MFC modules). As the right power lever was recorded in the take off position by the FDR, the torque indication value was then detected to be below 25%.

#### **Summary of NVM findings**

- No error other than the invalid TQ needle indication was detected by the MFC since the last deletion of the MFC memory (maintenance action);
- AFU #2 reported TQ values of ENG 2 lower than 25% to the MFC for more than 30 seconds; and
- The autofeather system was triggered during the occurrence flight.

#### **1.16.5.3 PECs and EECs Data Download**

Two engine electronic controls (EECs) and two propeller electronic controls (PECs) were removed from the occurrence aircraft and sent to the manufacturer, Hamilton Sundstrand at Windsor Locks, Connecticut, USA, for NVM data download. The data download was performed by the manufacturer under the supervision of representatives from the NTSB, TC and P&WC between 20 and 22 April 2015. The subsequent technical report was submitted to the ASC on 20 May 2015. Table 1.16-5 contains the EEC and PEC identifying information.

Table 1.16-5 Basic EEC and PEC information

	P/N	S/N	Position
EEC	1012974-4-002	14040035	No.1 / left
EEC	1012974-4-002	13100020	No.2 / right
PEC	816332-5-401	13070018	No.1 / left
PEC	816332-5-401	13080013	No.2 / right

The data download and technical report indicated that both PECs had no induced failures and no fault codes for the occurrence flight. Both EECs passed the power up test and contained some stored fault codes. Each of those fault codes occurred on the flight prior to the occurrence and was most probably caused by the power-up sequence of the EEC, DCU, AFU, and air data computer (ADC).

#### 1.16.5.4 Wiring Harnesses

The wiring harnesses connecting the No. 1 torque sensors to the AFUs of both engines were removed from the occurrence aircraft and dispatched to BEA for further examination. A visual or macroscopic inspection and X-ray examination were conducted. The connection between the torque sensor and the AFU was achieved through (see Figure 1.16-7):

- Pin H and pin J on the AFU connector; and
- Pin No. 1 and pin No. 2 on the torque sensor connector.

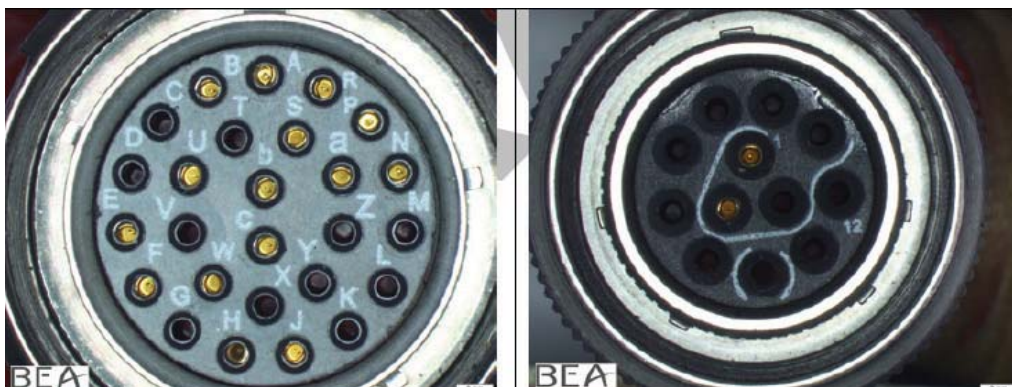

Figure 1.16-7 Connectors of AFU (left) and torque sensor (right)

The X-ray examination of both harnesses showed no anomaly. The X-ray pictures of the connectors which connect AFU and the torque sensor of ENG 2 are shown in Figure 1.16-8.

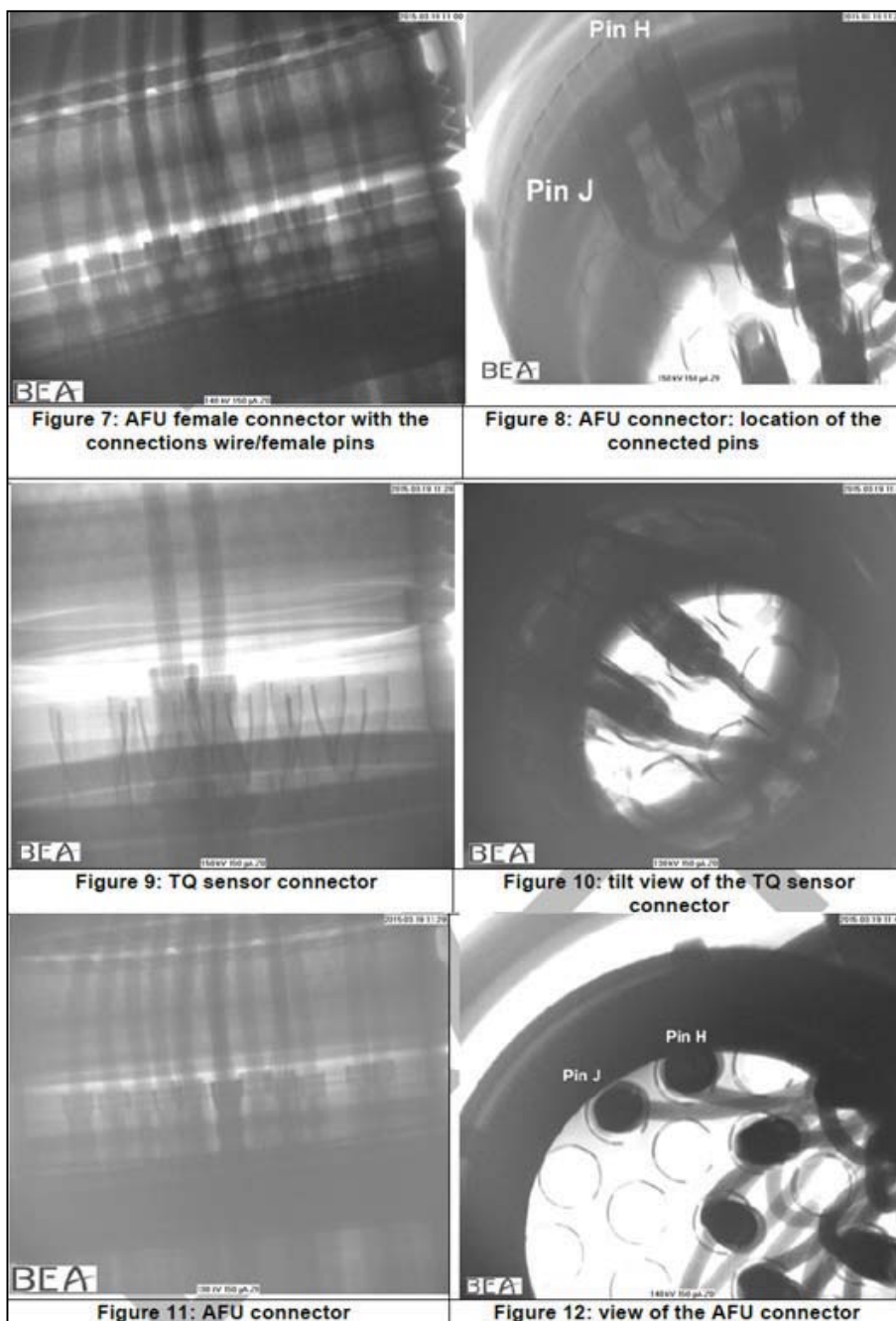

Figure 1.16-8 X-ray examination of AFU and torque sensor connectors

The macroscopic examination identified a difference between pin H on ENG 2 AFU connector and the other pins on that connector. Figure 1.16-9 shows AFU No.2 connector pins H and J.

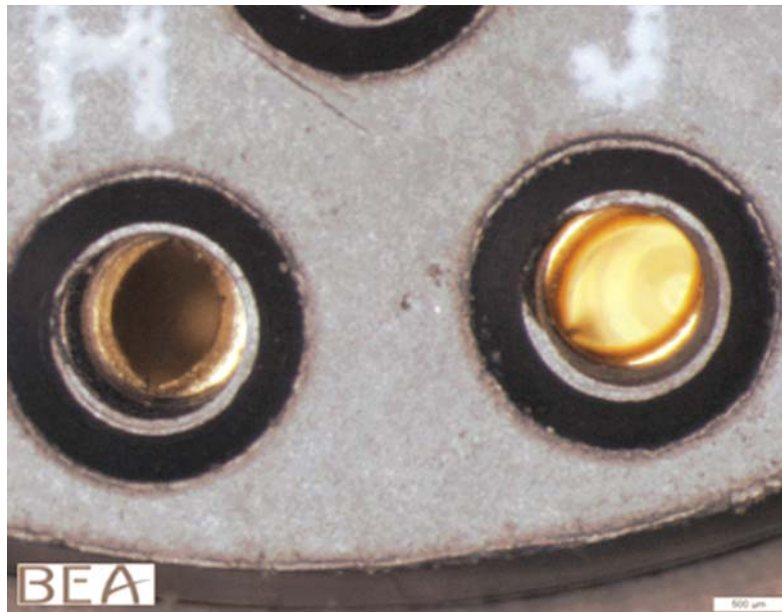

Figure 1.16-9 Connector pins H (left) and J (right) of AFU No. 2

The wiring harness was brought to UTAS Rosemount Aerospace for a continuity check. The continuity check of pins J and H indicated that the resistances were 0.20 ohms and 0.21 ohms respectively.

### 1.16.5.5 Engine Sensors

Twelve engine sensors including right torque, left torque, Np speed, lower Nh speed, upper Nh speed and Nl speed sensors of ENG 1 and ENG 2 which removed from the occurrence aircraft were sent to P&WC via TSB for testing. After all necessary tests finished, P&WC provided ASC a report on June 22, 2015, document number RFA No 15ECN00082 SI File No: 15-006. According to the report, observations recorded from testing of the speed and torque sensors were indicative of immersion in water and impact. Test results are summarized in Appendix 4. The detailed examination and test of torque sensors of ENG 2 as follows,



### **ENG 2 torque sensor left S/N CH1468**

This sensor was on the engine at initial engine delivery. The shop examination results of this sensor as follows,

Dark residue was present on the torque sensor probe-tip. The magnet was recessed into the probe tip. The interior of the electrical connector was clean and dry. The body of the probe was bent (see Figure 1.16-10). The packing was present on the tip and appeared to be damaged. Following removal of the wiring harness a small amount of white residue was observed in the sensor electrical connector. Oil and crystal residue was present in the packing groove. Chemical analysis of the residue identified fiber-like material composed of silicon with oxygen and sodium (possibly glass-fiber). Silicon and iron with oxygen, aluminum and potassium was also present. This was suggestive of environmental debris and magnesium-oxide.

The sensor was tested in accordance with test record sheet TR0736 Rev. 04 (P&WC ACMM 3075736 Rev. 1). The following observations were recorded:

- Test point 4.2 Coil winding resistance: with the sensor at room temperature there was an open circuit between pins 3 and 4.
- Test point 6.2 Dynamic test: with the gap between the sensor tip and the phonic wheel set at 0.035in, and the phonic-wheel speed set at 639RPM the peak to peak voltage between pin 1 and 2 was 0.85volts. This was below the test point minimum limit of 1.5volts.
- Test point 6.3 Dynamic test: with the gap between the sensor tip and the phonic wheel set at 0.035in, and the phonic-wheel speed set at 4263RPM the peak to peak voltage between pin 1 and 2 was 5.21volts. This was below the test point minimum limit of 8.9volts.
- Test point 6.6 Dynamic test: with the gap between the sensor tip and the phonic wheel set at 0.035in, and the phonic-wheel speed set at 4263RPM the peak to peak voltage between pin 3 and 4 was 5.94volts. This was below the test point

minimum limit of 8.9volts.

- Test point 6.2 to 6.6 Dynamic test: The peak-to peak voltage was erratic throughout this series of tests.

Note: The reference values quoted for each test point represent values for these parameters extracted from the appropriate component maintenance manual or overhaul manual test procedures. The component maintenance manual or overhaul manual ranges of values are those used to re-certify an accessory and are provided here for reference purposes only.

3D X-ray analysis (see Figure 1.16-11) of the sensor indicated that the coil wires had broken at the outside of the bend due to the impact.



Figure 1.16-10 External view of ENG 2 torque sensor left S/N CH1468

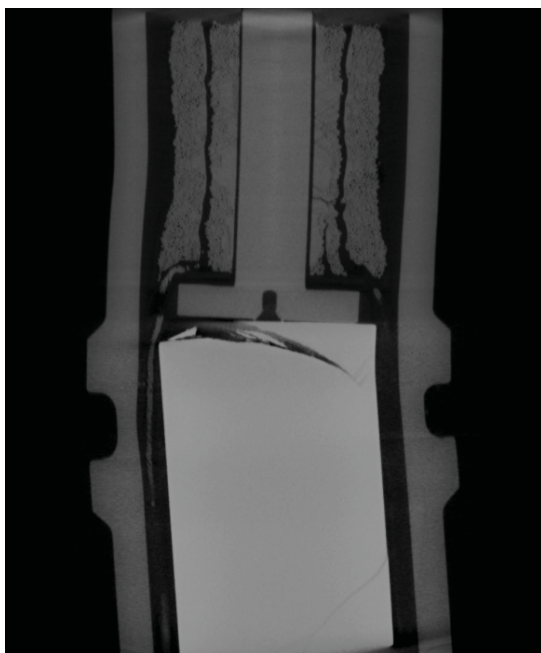

Figure 1.16-11 3D X-ray view of ENG 2 torque sensor left S/N CH1468

**ENG 2 Torque sensor right S/N CH1457**

This sensor was not on the engine at initial engine delivery. The shop examination results of this sensor as follows,

Dark residue was present on the torque sensor junction-box. There was a small amount of dark residue and contact marks on the probe tip. The end of the wiring harness was attached to the electrical connector and secured with a heat-shrink sleeve. The packing was present on the tip and appeared to be intact. Following removal of the wiring harness a small amount of clear liquid was observed inside the sensor electrical connector. Iron-oxide with traces of silicon and aluminum were identified on the probe tip.

The sensor was tested in accordance with test record sheet TR0736 Rev. 04 (P&WC ACMM 3075736 Rev. 1). The following observation was recorded:

- Test point 6.2 Dynamic test: with the sensor installed with an air gap of 0.035in from the phonic-wheel, and the wheel speed set at 639RPM the voltage between pin 1 and 2 was 1.49 volts peak-to peak. This was slightly below the test point

minimum limit of 1.5 volts peak-to peak.

- Test point 6.3 Dynamic test: with the sensor installed with an air gap of 0.035in from the phonic-wheel, and the wheel speed set at 4263 RPM the voltage between pin 1 and 2 was 8.5 volts peak-to peak. This was slightly below the test point minimum limit of 8.9 volts peak-to peak.

Note: The reference values quoted for each test point represent values for these parameters extracted from the appropriate component maintenance manual or overhaul manual test procedures. The component maintenance manual or overhaul manual ranges of values are those used to re-certify an accessory and are provided here for reference purposes only.



Figure 1.16-12 External view of ENG 2 torque sensor right S/N CH1457

## 1.17 Organizational and Management Information

### 1.17.1 Flight Operations Division

The head of TNA's Flight Operations Division (FOD) was designated an assistant vice president (AVP). The FOD comprised an Administration and Scheduling Department, Fleet Management Department and Standard, Training and Development Department. The FOD organization chart is shown in Figure 1.17-1.

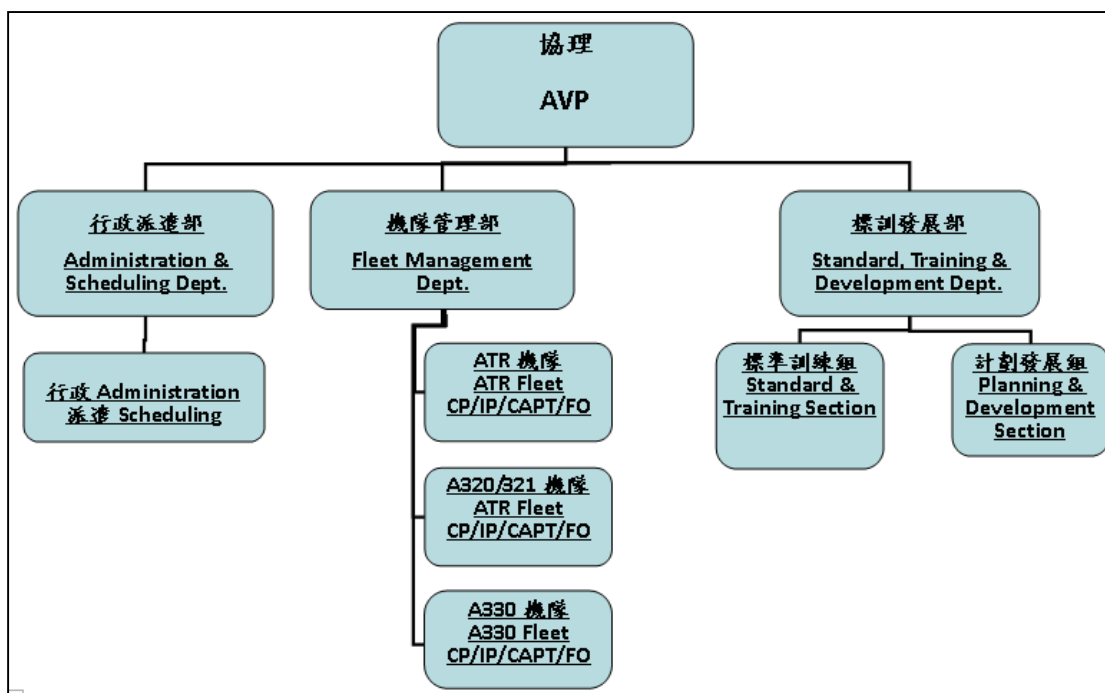

Figure 1.17-1 TNA Flight Operations Division Organization chart

The Standard, Training & Development Department (STDD) included two sections: standards and training; and planning and development. The department was responsible for the training and checking of all TNA pilots. The STDD provided the following flight crew training and checks for all aircraft, including the ATR fleet:

- (a) Aircraft type training;
- (b) Ground school;
- (c) Initial training;
- (d) Recurrent training;
- (e) Transition training;
- (f) Upgrade training;
- (g) Instructor and examiner training;
- (h) Ab-initio training;
- (i) Re-qualification training; and

(j) Cross crew qualifications(for Airbus fleet) or differences training (for ATR fleet).

In addition, the STDD also provided dangerous goods training and special operations training, such as reduced vertical separation minimum (RVSM), performance based navigation (PBN), extended range two engine operations (ETOPS), low visibility operations (LVO), cold weather operations, high elevation airport operations, and fatigue management.

The CAA had authorized STDD to nominate suitably qualified and experienced training captains as designated examiners (DE) to conduct aircraft type rating training and checks. Between 2011 and 2013, only one pilot had failed a proficiency check on the ATR72 fleet. All other pilots on the fleet had passed the type rating, proficiency and line checks during that period. However, as a result of the GE235 accident, the CAA required that TNA's ATR72 pilots be required to undertake supplementary proficiency tests with higher standard for risk control. A total of 55 pilots took the supplementary proficiency tests.

The evaluations were conducted by the CAA and designated examiners. Ten pilots failed the oral test and a further 19 pilots did not undertake the test because of sickness or they were not in Taiwan at the time. Twenty nine pilots were suspended for a month pending a re-test. One captain was subsequently demoted and several pilots left the airline. The remaining suspended pilots subsequently passed the re-test.

#### **1.17.1.1 Initial ATR72 Training**

TNA ATR72 initial pilot training comprised the following:

- (a) Ground school: was conducted by either e-learning or in the class room for teaching aircraft systems, aircraft performance, related regulations, and safety and emergency procedures;
- (b) Line observation: total of 8 flights; four flights to be completed before commencing simulator training and the remaining four flights to be undertaken before commencing initial operating experience (IOE);

- (c) Simulator training: total of 18 sessions covering normal, abnormal and emergency procedures, including windshear, controlled flight into terrain (CFIT), traffic alert and collision avoidance system (TCAS), and unusual attitude recovery (UAR). Seven sessions were conducted in a fixed-based simulator and 11 sessions were conducted in a full flight simulator;
- (d) Local training: local training included two training flights in the actual aircraft and one check flight;
- (e) Initial operating experience (IOE): comprised three different phases. Phase 1 focused on PM duties; phase 2 focused on PF duties; and the last phase emphasized total crew performance; and
- (f) Trainees were required to pass a final line check prior to being designated a fully qualified line pilot.

### **1.17.1.2 Recurrent Training**

The Standard, Training & Development Department also provided a recurrent training program for pilots every 6 months. Two recurrent training sessions and their associated checks were to be conducted within a twelve calendar month period. The training was to be completed before each of the checks. The interval between the two checks was within four to eight calendar months. The recurrent training program comprised ground school and simulator sessions. The ground school component was a minimum of 20 hours per year.

## **1.17.2 First Officer to Captain Upgrade Process and Training**

### **1.17.2.1 Captain Upgrade Selection Process**

The airline's command upgrade (promotion from first officer to captain) procedures were documented in section 5-3 of the flight operations department operations manual (FODOM). The first stage of the command upgrade selection process involved FOD compiling a list of FOs who met the qualifications and

experience requirements for upgrade specified in Chapter 10 of the FOM. Potential upgrade candidates were then recommended by instructor pilots (IPs). Those potential candidates who were not recommended by IPs for upgrade were to undertake additional remedial training to rectify the areas requiring improvement. The FOD also submitted a report to the airline President detailing the number of pilots required for upgrade training. On approval of the numbers specified, designated upgrade candidates were required to undertake technical and other tests within a specified period and score 90 points or higher. The performance of candidates who met the criteria for that stage were reviewed by a panel of at least two-thirds of the fleet instructor and check pilots (IPs/CPs) who then conducted oral tests of the candidates. The selection panel then calculated final scores and ranked the candidates for upgrade training. A candidate whose oral test score was below 60 points as determined by at least one-third of the panel was not recommended for upgrade training.

Three ATR72 First Officers, including GE235's Captain A, attempted the above oral test on 7 April 2014. The selection panel assessing the candidates oral test performance comprised six ATR72 IPs/CPs. The airline's ATR72 fleet had a total of 12 IPs/CPs at that time. One of the assessors scored all those candidates below 60 points. Another assessor scored all the candidates 60 points. The remaining assessors scored all the candidates above 60 points.

### **1.17.2.2 Upgrade Ground Training**

Section 2.4 of TNA's flight training management manual (FTMM) outlined the components of upgrade training: ground training; flight simulator training; and line training. FTMM section 2.4.2 "Ground Training" stated that the ground test was to be conducted after the completion of all ground courses.

Four ATR72 first officers attended the upgrade training in 2014. Three of the candidates, including Captain A, did not complete all the ground courses until after the ground test on 12 May 2014. That was not in accordance with the airline's documented



upgrade training procedures. According to the interview note, the justification for not following the documented process was that they were assigned flying duties during the ground training periods.

### **1.17.3 ATR72-500 to ATR72-600 Differences Training**

#### **1.17.3.1 EASA Operational Evaluation Board Report**

TNA's ATR72-500 to ATR72-600 differences (hereinafter "ATR72-600 differences") training program was developed in accordance with the European Aviation Safety Agency (EASA) ATR42/72 Flight Crew Qualifications Operations Evaluation Board (OEB) report<sup>52</sup>. There were various types of ATR72-600 differences training programs depending on the pilot's total flight time, type experience, and the configuration and onboard equipment of previous ATR72 aircraft flown. The two standard ATR72-600 differences training programs recommended by the OEB report included 5-day and 10-day programs. The pre-requisites for the 5-day program required pilots to be current and qualified on the ATR72-500 and have a minimum experience on ATR aircraft of 500 hours in total or 100 hours in the last twelve months. Pilots not meeting those pre-requisites should undertake the 10-day program.

Section 6.7.1 of the OEB report listed a series of items<sup>53</sup> that should receive special emphasis at the appropriate point during the ground and flight differences training, and included in part:

- Engine malfunctions during take off;
- Use of avionics in normal and abnormal / emergency operations, including flight mode annunciation (FMA) annunciations, caution and warning messages on the engine & warning display (EWD), and associated human factors issues;
- Use of flight management system (FMS);

---

<sup>52</sup> European Aviation Safety Agency operational evaluation board report, ATR 42/72 Flight Crew Qualifications Revision 3, 23 August 2013.

<sup>53</sup> TASE: training areas of special emphasis.

- Use of electronic checklist (ECL); and
- Crew resource management (CRM) with regard to the new functionalities.

The recommended requirements for familiarization flights following ATR72-600 differences training were listed in section 9.3.2 of the OEB report. Pilots who met the pre-requisites for the 5-day differences training program should undertake familiarization flights ranging from 6 to 10 sectors flown as PF or PM, taking into account overall ATR and/or glass cockpit experience. The pilots who did not meet the experience pre-requisites and required the 10-day differences training program should be recommended to undertake familiarization flights ranging from 25 to 30 sectors as PF or PM.

### **1.17.3.2 TNA ATR72-600 Differences Training Program**

Before operating the ATR-600, current TNA ATR72-500 pilots completed ATR72-600 differences training. TNA's ATR72-600 differences training was conducted by ATR in accordance with section 2.18 of the flight training management manual (FTMM). The differences training syllabus is presented in Appendix 5. An additional simulator check was to be conducted by the designated examiner (DE) or CAA inspector following the ground and simulator training.

After passing that simulator check, the flight crews were required to complete at least eight sectors of line training followed by a two sector line check as part of the ATR72-600 initial operating experience.

### **1.17.4 Crew Resources Management Training**

The ASC's GE222<sup>54</sup> investigation report detailed the non-technical skills

---

<sup>54</sup> On July 23, 2014, TransAsia Airways passenger flight GE 222, an ATR-72 airplane, registration number B-22810, took off from Kaohsiung International Airport for Penghu Magong Airport. There were 58 people on board, including 2 flight crewmembers, 2 cabin crewmembers and 54 passengers. The aircraft crashed in Xixi Village near Magong Airport at 19:06L when conducting the RWY 20 VOR approach, caused 48 fatalities and 10 serious injuries. Five residents on ground suffered minor injuries.

(NOTECHS)<sup>55</sup> recurrent training conducted at TNA. Any applicable updated TNA NOTECHS information since that occurrence is presented in this section. Section 1.18.2.1 of this report presents extracts from TNA's flight operations manual pertaining to NOTECHS.

#### **1.17.4.1 Training Policy**

The flight training management manual (FTMM) documented TNA's crew resource management (CRM) training policy for flight crew. The publication of the most recent edition<sup>56</sup>, of the FTMM was within one month of the GE235 occurrence. The CRM training received by the GE235 flight crew was based on the previous edition of the FTMM.

CRM training for flight crew as documented in the most recent and previous edition of the FTMM included:

##### **CRM training current at the time of occurrence**

- A four hour LOFT<sup>57</sup> course conducted in a FFS for each of the following phases of training: initial; command upgrade; and transition training;
- A four hour CRM ground course delivered as part of initial training. The course content included: definition of CRM, automation, logic of CRM application, CRM policy, CRM development, CRM skills, error avoidance, decision making process, threat and error management (TEM), communication, and case introduction;
- After the completion of initial training, all flight crew completed a recurrent CRM ground course every 24 months. The FTMM did not stipulate minimum training

---

<sup>55</sup> The distinction between technical and non-technical skills (NOTECHS) has been widely used in the aviation domain to differentiate between a pilot's psychomotor and technical abilities and the interpersonal skills and other behaviors required to function effectively as a pilot, particularly in a multi-crew environment. It has been epitomized by crew resource management (CRM) and threat and error management (TEM) skills. NOTECHS includes skills pertaining to leadership, communication, decision-making, and situation awareness.

<sup>56</sup> 33<sup>rd</sup> edition of the FTMM dated 8 January 2015.

<sup>57</sup> Line-oriented flight training.

hour requirements for recurrent CRM ground courses; and

- The philosophy and practice of CRM skills shall be an integral part of training courses in the simulator and aircraft, and formed part of both the initial and annual recurrent training.

### **CRM training received by occurrence flight crew**

- Four hour CRM ground course as part of initial training on joining the airline. The FTMM did not contain any CRM ground course content. After completion of initial training, all flight crew received a recurrent CRM ground course at least every 3 years. The recurrent CRM ground course was included in the safety recurrent training conducted by the Safety and Security Office. While the FTMM did not stipulate minimum training hour requirements for recurrent CRM ground courses, CRM training records and the Safety Management Manual indicated that the duration of recurrent CRM training was one hour every two years.
- CRM training was to be incorporated into recurrent simulator training at least once a year; and
- LOFT concepts were to be integral to recurrent simulator training (4 hours) once a year. Such training was to be administered real-time in a line environment setting and involved an uninterrupted planned scenario with specific CRM objectives where such skills were observed and debriefed upon completion.

The TNA flight crew training supervisor and assistant manager advised that prior to the GE235 occurrence, the CRM instructional methods used in the simulator varied in accordance with the IP's experience. That is, it was not standardized. TNA did not provide CRM instructional methods training or guidance to its IPs so they could effectively incorporate and assess the practice of CRM skills in simulator training, including the development of detailed LOFT scenarios with specific CRM objectives. In addition, IPs rarely used videos of simulator training to discuss CRM performance with the crews during training debriefing.

#### **1.17.4.2 CRM and Human Factors Ground Course Material**

The TNA flight crew CRM courses focused on CRM development history. Each CRM instructor had their own training materials. Therefore, the CRM training was not standardized. TNA safety staff advised that the CRM training materials essentially included information on topics listed in Chapter 5 of the FOM, which included: CRM skills; error avoidance; threat management; error management; and decision making.

#### **1.17.5 Training Records Management**

The CAA required an operator to establish a system to retain all training records for inspection in accordance with Article 21 of the Aircraft Flight Operation Regulations.

The management of TNA flight operations records and data was prescribed in the FODOM section 11-9. The following flight operations records and data were to be preserved for a specified time interval: flight and duty time records (for at least one year); flight documents (at least 3 months); pilot rosters (at least 2 years); personal data and training records, including successful and unsuccessful flight crew evaluations (for the duration of the employment period). After the required retention periods, the records may be disposed of. Furthermore, the records were to be legible, maintained and locked in proper storage devices (such as metal cabinets) with protection/security functions, and were to be accessed by authorized personnel only.

Before the GE 235 occurrence, crew ATR72-600 differences training records were not well maintained by the Flight Operations Division. However, the TNA ATR72-600 differences training records were retained by ATR, who delivered the training.

#### **1.17.6 ATPCS Check Associated Policy and Procedures**

The ATPCS is a subsystem of the powerplant unit. The ATPCS provides, in case of an engine failure during takeoff, uptrimming of take off power for the remaining engine combined with the automatic feathering of the failed engine.

### **TNA ATPCS Check Policies**

The TNA Flight Operations Division had issued two technical circulars to ATR pilots<sup>58</sup>, in order to reduce the aborted takeoff rates due to the ATPCS not indicating 'armed' during the take off roll in 2011 and 2012.

On 30 November 2011, TNA issued the first technical circular:

- Technical circular No.1001130p in 2011,

The circular required flight crew to add an extra item in the take off briefing as follows: flight crew shall check the regulated take off weight (RTOW) limitation during the take off briefing. If the actual take off weight was below the RTOW limitation, flight crew can continue to take off even if the ATPCS was not indicating 'armed' during the take off roll. Otherwise, the flight crew shall abort take off.

In February 2012, TNA consulted ATR that whether the pilots could continue take off when the takeoff power set and the pilots found the ATPCS "ARM" light not illuminated during takeoff while the aircraft weight is not heavy (ATOW lower than RTOW with ATPCS off). The ATR commented that if the ATPCS light does not illuminate and the aircraft speed was below V1 at a very low speed, the safest solution is to abort take off and see what's going on with the aircraft.

On 26 April 2012, TNA had an IP/CP meeting to discuss the ATPCS issue. The meeting minutes indicated that the TNA ATR-500 pilot could continue take off when ATPCS ARM indicator did not lit during take off roll while the weight was within limit.

On 4 June 2012, TNA issued the second technical circular:

- Technical circular No. m1010604x in 2012

The circular included detailed procedures and attachments (airplane flight manual (AFM) Supplement 7\_02.10) regarding the ATPCS not arming as follows:

1. Before engines start, flight crew shall check the RTOW chart according to weather

---

<sup>58</sup> The TNA only had ATR72-500 aircraft at that time.

conditions to acquire take off weight limitation and performance data;

2. If the ATPCS is not armed, pilot flying shall apply reserve take off (RTO) power by pushing both power levers to the RAMP position, and order pilot monitoring to select ATPCS“OFF” and bleed valves “OFF”; and
3. After take off, set both power levers into Notches position, and then select both bleed valves to “ON” while conducting an after take off checklist.

The TNA flight crew training supervisor stated at interview: the above technical circulars only applied to ATR72-500 operations. ATR72-600 pilots were trained to abort the take off if the ATPCS was not armed during the take off roll.

The related TNA ATPCS operational procedures were as follows:

- Dispatch with ATPCS OFF procedure

This procedure (Appendix 6) was described in the airplane flight manual (AFM) Supplement 7\_02.10. While the ATPCS may be inoperative, flight crew can follow this procedure to dispatch the aircraft.

- ATPCS Static Test procedure

This procedure was described in the ATR72-600 SOPs ‘Preliminary Cockpit Preparation’ section (page 5-17).The flight crew shall conduct this test procedure to check the function of the ATPCS during preliminary cockpit preparation.

- ATR72-600 Normal checklist

The flight crew shall check “ATPCS Off (inoperative) Take Off Weight” while conducting take off briefing. See Appendix 7.

- Take off procedure

This procedure was described in the ATR72-600 SOPs ‘Take off’ section (page 12-1) CM1 shall check if the ATPCS is armed or not and then announce the result (see section 1.18.2.2).

- ATPCS Dynamic Test procedure

This procedure was described in the ATR72-600 SOPs ‘Daily Checks’ section (page 23-1). The flight crew shall conduct this procedure to check the

function of the ATPCS at the end of final flight sector of a day.

The TNA flight crew training supervisor at interview stated: it was emphasized during flight crew training that ATR72-600 pilots should abort the take off if the ATPCS is not armed during the take off roll. Several procedures shall be conducted while the ATPCS was not armed, but it was inappropriate to perform those procedures during the take off roll. This was why crews were required to abort the take off. However, the above policy was not clearly documented in any of the company manuals or communicated in notices to flight crew.

### **ATR ATPCS Check Policies**

After the occurrence, the ATR provided a statement of the SOP policy regarding the checks performed during takeoff and focus on ATPCS checks (see Appendix 8), excerpts from the statement as follows,

*The purpose of the Standard Operating Procedures (SOP) is to ensure the aircraft is in the appropriate configuration for all phase of flight, including take-off. By definition, any check not completed halts the procedure and take off cannot proceed.*

*This is the industry norm.*

*As per ATR SOP, Refer to FCOM 2.03.14, the above policy applies to all the below actions related to checks during the take off roll before V1:*

- *Check of the FMA*
- *Check of the ATPCS*
- *Check of the Engine Parameters*
- *Check of the Power Setting*
- *Check of the 70kt speed indication and associated checks (availability of both flight crew members for take off, transfer of controls)*

*The objective of the action line, “ATPCS ARM...CHECK then ANNOUNCE”, is to confirm the availability of the ATPCS for the take off in the actual conditions.*

*At take off power initiation, PL1+2 set in the notch, if the check of ATPCS armed*



*condition is negative, ARM light not lit, means that the ATPCS is not available.*

*To emphasize this point, ATR issued the OEB No. 27<sup>59</sup> which states: “The ATPCS must be checked armed and announced (FCOM 2.03.14). If it is not armed while both power levers are in the notch, or in the case of intermittent arming / disarming of the ATPCS, the take off has to be interrupted, as for any other anomaly intervening during the take off run.”*

### **1.17.7 Civil Aeronautics Administration Regulatory Safety Surveillance/Inspection Program**

Civil aviation regulatory surveillance programs are undertaken in a systematic manner to provide an assessment of the aviation industry’s safety level and to implement appropriate responses. The quality assurance approach strongly supports an appropriately developed regulatory surveillance program that should continuously strive to achieve the quality characteristics of:

- Effectiveness;
- Consistency; and
- Efficiency.

Any regulatory body sets its standards by its promulgated regulatory requirements. CAA is a regulatory body and sets the standards for Taiwan aviation by its regulatory framework and subordinate legislative documentation.

Compliance with those regulatory requirements achieves a minimum level of aviation safety. There are non-regulatory factors assessed as risk indicators which in themselves, either individually or collectively, can affect aviation safety.

CAA’s surveillance and inspection programs enable compliance activities to be conducted to determine the level of industry compliance with the regulatory requirements and to record observations on safety risk indicators. The information obtained from surveillance activities provides a basis to follow up with appropriate

---

<sup>59</sup> The OEB was issued in March 2015.

corrective actions that can range from compliance guidance, education and counselling to enforcement.

The role of regulatory inspections is to:

- identify the current practices;
- establish that the practices were appropriate;
- establish that the documentation matched the practices;
- review the system for regulatory compliance;
- determine if the operators' staff were appropriately qualified and trained; and
- identify any immediate safety-significant problems.

CAA's operator surveillance and inspection program included in-depth and cockpit enroute inspections at specified intervals, special inspections, and industry meetings. The inspection procedures were outlined in the CAA Operations Inspector's Handbook. The airline's designated principal operations inspector (POI) was the primary interface between the operator and CAA. The GE222 investigation had identified specific areas for enhancement in CAA's regulatory surveillance activities and they will not be discussed further in this report.

However, of note is that the CAA conducted an in-depth inspection of TNA's Flight Operations Division (FOD), System Operations Control (SOC) and the Safety and Security Office (SSO) after the GE222 accident in August 2014 and identified multiple safety deficiencies which included but were not limited to:

- Lack of standardization in flight crew training and checking activities;
- Crew resource management problems;
- Flight crew non-compliance with procedures.

In addition, the GE222 and previous ASC safety investigations had identified systemic flight crew non-compliance with procedures on the line and during training at TNA. These safety issues were still being addressed by the airline at the time of the GE235 occurrence.

## **1.18 Additional Information**

### **1.18.1 Factors Affecting Flight with One Engine Inoperative**

Safe flight with one-engine inoperative required an understanding of the basic aerodynamics involved and proficiency in one-engine inoperative procedures. Loss of power from one engine affected both climb performance and controllability of multi-engine aircraft. An important consideration for multi-engine aircraft performance is to minimize aerodynamic drag in the event of an engine failure in flight. Drag can be caused by a windmilling propeller, extended landing gear and wing flaps, control surface deflection or aircraft attitude. In wings level one-engine inoperative flight, an aircraft will sideslip while maintaining heading, thus increasing drag. Banking up to 5 degrees toward the operating engine reduces drag, by reducing the sideslip, as well as the amount of rudder required to counteract yaw. Drag from a windmilling propeller will cause an aircraft to yaw towards the failed or failing engine.

Many multi-engine turboprop aircraft, including the ATR72, are equipped with auto feathering propellers. Auto feathering feathers the propellers without pilot input in response to a powerplant malfunction where the engine torque value reduces below the pre-defined threshold. Feathering results in the propeller blades being streamlined to the direction of aircraft travel and the propeller blade ceasing to rotate, which minimizes drag and therefore the yawing tendency in the event of an engine failure or shutdown in flight.

The occurrence aircraft had surplus performance available after the uncommanded autofeather and was able to continue climbing without difficulty on one engine under the full control of the flight crew.

#### **1.18.1.1 Critical Speeds for a Powerplant Malfunction or Shutdown after Take off**

##### **Air Minimum Control Speed ( $V_{MCA}$ )**

A multi-engine aircraft equipped with wing-mounted engines will experience asymmetric thrust if one engine suffers a total or partial loss of power. Consequently, the aircraft will yaw towards the failed engine, and the pilot must counteract that asymmetric thrust moment by applying rudder towards the operative engine. The rudder's effectiveness will depend on the velocity of airflow across it. If the aircraft decelerates, the airspeed will eventually reach a speed below which the rudder moment can no longer balance the asymmetric thrust moment. Directional control will then be lost.

$V_{MCA}$  is the minimum speed at which it is possible to maintain directional control of the aircraft with the critical engine inoperative. When flown at  $V_{MCA}$ , and with a bank angle of approximately five degrees towards the operating engine, the pilot should be able to maintain directional control of the aircraft. The aircraft certification process includes demonstration of  $V_{MCA}$ . JAR 25.107 require that the take off safety speed ( $V_2$ ) must not be less than  $1.1 V_{MCA}$ . Therefore, if an aircraft is flown at  $V_{MCA}$  rather than the  $V_2$  speed following an engine failure, climb performance will not be achieved. By banking the aircraft towards the operative engine, the wings develop a lateral force that results in the aircraft sideslipping towards the operative engine. The sideslip creates a positive angle of attack of the airflow over the rudder. The resulting moment around the aircraft CG counters the moment produced by operating with one engine inoperative, and the other engine producing thrust.

$V_{MCA}$  for the occurrence aircraft was approximately 99 knots indicated airspeed (KIAS).

### **Minimum Flight Speed ( $V_{MCL}$ )**

The manufacturer defined a minimum flight speed ( $V_{MCL}$ ) at which the aircraft can be controlled with five degrees of bank in case of failure of the critical engine, the other set at go-around power (landing flaps setting, gear extended) and which provides rolling capability specified by regulations.

$V_{MCL}$  for the occurrence aircraft was approximately 98 KIAS.

### **Reference Stall speed ( $V_{SR}$ )**

An aircraft's stall<sup>60</sup> speed is the minimum steady flight speed at which the aircraft is controllable in a given configuration. The manufacturer defined  $V_{SR}$  as the 1 g stalling speed for a specified configuration. It is a function of the aircraft's weight.

$V_{SR}$  for the aircraft at the time of the occurrence was 97 KIAS.

### **Take off safety speed ( $V_2$ )**

The take off safety speed ( $V_2$ ) may be defined as the speed selected to ensure that adequate aerodynamic control will exist under all conditions (including sudden, complete engine failure) during the climb after take off.  $V_2$  is never less than 1.1  $V_{MCA}$ , or 1.2  $V_{SR}$ . The manufacturer defined  $V_2$  as take off safety speed reached before 35 feet height with one engine failed and providing second segment climb gradient not less than the minimum (2.4%).  $V_2$  for the occurrence flight was 110 KIAS.

### **Final take off speed ( $V_{FTO}$ )**

The final take off speed ( $V_{FTO}$ ) for the occurrence aircraft was 134 KIAS.  $V_{FTO}$  is the speed of the aircraft that exists at the end of the take off path in the en-route configuration with one engine inoperative.

## **1.18.2 Manual Information**

TNA provided flight operations related policies, requirements, procedures, and guidance to flight crews in several documents, the detailed are shown as below:

### **1.18.2.1 Flight Operations Manual**

The current TNA flight operations manual (FOM) revision 42, published on 1 February 2015, establishes general procedures and provides instructions and guidance

---

<sup>60</sup> *Jane's Aerospace Dictionary*, 1988, describes a stall as a 'Gross change in fluid flow around [an] aerofoil ... [at an angle of attack] just beyond [the] limit for attached flow, ... characterised by [a] complete separation of [the] boundary layer from [the] upper surface and [a] large reduction in lift.'

for use by flight operations personnel in the performance of their duties.

### **PF/PM Task Sharing**

The Chapter 3 "duties and responsibilities" contains the following information regarding pilots' task sharing:

#### ***3.8 PF/PM Task Sharing***

1. *Whenever irregularities occur during flight that have effect on aircraft operation or result in serious failure, the Captain shall immediately take over the control from FO and serve as PF. If the PF/CM2 is a Captain, the other Captain (CM1) shall exercise CRM principle and take over the control if necessary for safety concerns.*
2. *For task sharing between PF/PM for normal operations, see relevant SOPs.*
3. *The general task sharing shown below applies to both emergency and abnormal procedures.*
  - a. *The pilot flying remains pilot flying throughout the procedure.*
  - b. *For Airbus 320/321/330:*

.....

- c. *For ATR72:*

*PF is responsible for:*

- *power lever*
- *flight path and airspeed control*
- *aircraft configuration*
- *navigation*
- *communications*

*PM is responsible for:*

- *Monitoring and check list reading*
- *execution of required actions*
- *actions on overhead panel*
- *condition lever*

*Note: The Automatic Flight Control System (AFCS) is always coupled to the PF side (Couple selection).*

## **CRM Policy**

The Chapter 5 "crew resource management" contains the following information regarding TNA CRM policy:

### ***5.4 TNA CRM Policy***

*TNA believes that optimally safe and efficient flight operations are best achieved when crewmembers work together as a coordinated team, fully utilizing all resources available to them –human resources, hardware and information.*

*To achieve this optimal level of performance, TNA further believes that all flight crewmembers must embrace CRM principles and techniques and apply them consistently in all aspects of flight operations.*

*Accordingly, the company has established the following CRM policy:*

- 1. CRM ability and a facility for teamwork will be criteria for flight crewmember selection.*
- 2. CRM principles and practices will be fully integrated into all aspects of flight operations training.*
- 3. All crewmembers will share the responsibility for establishing an environment of trust and mutual commitment prior to each flight, encouraging his fellow crewmember(s) to speak out and to accept mutual responsibility for the safety and well-being of the passengers and equipment entrusted to them. "What's right, not who's right" will be the motto of TNA crews.*
- 4. Each flight crewmember will be responsible for notifying the pilot in command if any condition or circumstance exists that could endanger the aircraft or impair the performance of any crewmember.*

### 5.7 Error Avoidance

- *Maintaining your health.*
- *High levels of training and proficient.*
- *Following SOP's.*
- *Proper use of checklists.*
- *Minimizing distractions.*
- *Planning ahead.*
- *Open two-way communication.*
- *Maintaining situational awareness.*

### 5.9 Error Management

- *Reasons for making errors: lack of experience; rushed; distractions; stress.*
- *Crews make mistakes several times during each flight, most of which are unimportant. However it can be beneficial to recognize and learn from errors, since it will help crewmembers manage resources better during the next flight.*
- *Types of Error:*
  - ***Intentional Noncompliance - Violations. Ex) Checklist from memory.***
  - ***Procedural - followed procedures with incorrect execution Ex) Wrong altitude setting dialed.***
  - ***Communication - Missing information or misinterpretation. Ex) Miscommunication with ATC.***
  - ***Proficiency - Lack of knowledge or skill. Ex) Lack of knowledge with automation.***
  - ***Decision - Crew decision unbounded by procedures that unnecessarily increased risk. Ex) Unnecessary navigation through adverse weather.***
- *Managing Errors:*
  - ***Once an error is committed, it is difficult for a crewmember to catch (trap) his/her own error. Other people are more likely to catch his/her error. Therefore, redundancy is one strong defense against error.***
  - ***Execution: Monitor/crosscheck; workload management; vigilance; automation management.***
  - ***Guidelines and techniques for effective challenging: timely; with***



*respect; constructive intent; specific; use questions.*

### **5.10 Decision Making Processes**

#### **5.10.1 General**

*The company has chosen a standard mnemonic – S A F E – to help remember the steps for effective decision-making. SAFE means:*

- S State the problem*
- A Analyze the options*
- F Fix the problem*
- E Evaluate the result*

#### **5.10.2 Priorities of Flight**

*Always take into account the following priorities when invoking the decision-making process:*

- a. Safety*
- b. Punctuality*
- c. Passenger Comfort*
- d. Economy*

## **Callouts and Sterile Cockpit Environment**

The Chapter 7 "flight operations procedure" contains the following paragraph regarding callouts and sterile cockpit environment:

### **7.3 Callouts**

- 1. Call Outs shall not interfere with ATC communications.*
- 2. To establish CRM, the communications between flight crewmembers shall be based on verbal standard callouts, rather than using looks.*
- 3. Except for the flight controls, power levers and deceleration systems, all switches and push buttons have to be changed or executed by PM under PF command (except as otherwise noted in specific aircraft type's SOP), who is responsible to cross check these positions are in the right position while the aircraft is in manual flight.*
- 4. All switches and push buttons are set by PF and cross – checked by PM when it is in auto pilot operation.*
- 5. Either auto pilot flight or manual flight; all the appeared flight mode*

*indications (ATR) and FMA (Airbus) have to be called out and crosschecked by PF or PM according to respective SOPs. Any deviation or movement of CDI shall be reported by PM and verified by PF.*

6. *To hand over the aircraft controls, the PF has to call:
 
  - a. *“YOU HAVE CONTROL”. As soon as positive control has been taken, PM must call: “I HAVE CONTROL”.*
  - b. *The PIC shall make a go-around immediately and call out “I have control” if the aircraft not stabilized during approach.*
  - c. *For seamless radio communications, when PM is busing in dictating metrological information or liaison with other units, he or she shall tell PF "YOU HAVE RADIO", then takes action after PF responses.**
7. *Use of Checklist:
 
  - a. *The PIC shall ensure that the flight crew utilizes checklists to comply with standard operating procedures and provisions of the certificate of airworthiness, which may include safety check, originating/receiving, before start, after start, before taxi, before take off, after take off, climb, enroute, before landing, landing, after landing, parking, emergency, non-normal, abnormal procedures checklists.*
  - b. *Normal Operation Checklist (placed in the cockpit)**

*Checklist Job Description:*

<b>Commander</b>	<b>Checklist Holder</b>
<i>Give command to checklist holder to execute the check, regularly, check the regulation and main procedure first, after completing the check, and inform checklist holder to read checklist.</i>	<i>Apply the check procedure as per one’s habit flow pattern.</i>
<i>Visually check the item being called and report its current position or function.</i>	<i>Check the prescribed checklist item with the response and execute the next checklist item. (Visually check the item, its position or its function if workload permits.)</i>

	<p><i>If the response is different from the checklist, a correction shall be made before proceeding to the next item.</i></p> <p><i>The checklist will not be completed if any item is standby unless the item is accomplished.</i></p> <p><i>Example: Checklist will be completed by _____.</i></p> <p><i>When _____ has been done, then call <b>"CHECKLIST COMPLETED"</b>.</i></p> <p><i>Example: During approach, if the seat belt light is not on, the Approach Checklist will be completed by Seat Belt on, when the seat belt light is on the Approach Checklist is complete.</i></p>
--	---

*c. Abnormal/Emergency Checklist (also QRHs, placed in the cockpit)*

- (i) During an abnormal or emergency condition, PF gives command to check and checklist is executed by PM with "Read and Do". PF is responsible for confirmation on the operations of switches and push buttons while maintaining aircraft in safe attitude.*
- (ii) All failing switches must be confirmed before turned off.*

**7.5.8 Sterile Cockpit Environment**

- 1. The company prohibits all activities in the cockpit not required for the safe operation of*

*the aircraft during critical phases of flight. These prohibited activities include non-safety related company calls, PA's, logbook entries, and non-essential conversations. Critical phases of flight include all ground operations involving taxi, take off, and landing, and all other flight operations conducted below 10,000 ft (for Airbus) or 5,000 ft (for ATR), except cruise flight.*

2.....

#### **7.5.10 Crew Monitoring And Cross-Checking**

1. *The PF will monitor/control the aircraft, regardless of the level of automation employed.*
2. *The PM will monitor the aircraft and actions of the PF.*
- .....
- .....
- .....
8. *Pilots shall make a cross-check by dual response before actuation of critical controls, including: i) thrust lever reduction of failed engine; ii) fuel Master/Control switch; iii) fire handle and extinguisher switch; iv) IDG Disconnect Switch.*

### **1.18.2.2 TNA Standard Operating Procedure**

The current TNA standard operating procedure (SOP) is revision 1, published on 20 January 2015 which established ATR72-600 operating procedures and provided specific procedures and techniques for flight crew.

#### **Sterile Cockpit**

The Chapter 1 "general information" states the following information regarding sterile cockpit environment:

- *The company prohibits all activities in the cockpit not required for the safe operation of the aircraft during critical phases of flight. These prohibited activities include non-safety related company calls, PA's, logbook entries, and non-essential conversations. Critical phases of flight include all ground operations involving taxi, take off, and landing, and all other flight operations conducted below 5,000 ft, except cruise flight.*
- *During the periods mentioned below, calls from the cabin to the cockpit shall, except in case of an emergency, not be made:*
  - a. *After take off: Until the turning off of seat belt sign.*
  - b. *Before landing: After being notified by the cockpit of reaching 5,000 ft. In case the period mentioned above is anticipated to become longer than usual, proper information shall be given from the cockpit.*

### **Crew Monitoring and Cross Checking**

The Chapter 1 "general information" contains the following information regarding crew monitoring and cross-checking:

- *If an indication is not in compliance with a performed action, crew members must check that involved system is correctly set and/or take any necessary action to correct the applicable discrepancy. PM can be temporarily busy (ATC message, listening to weather, reading operating manuals, performing related procedure action, etc). Any significant status change (AFCS, FMA, systems...) must be reported to PM when his attention is restored.*
- *When making auto flight systems inputs, comply with following items in the acronym CAMI:*
  - Confirm FMS inputs or performance calculations with the other pilot when airborne.*
  - Activate the input.*
  - Monitor Flight Mode Annunciator (FMA) to ensure the auto pilot system performs as desired.*
  - Intervene if necessary.*

*During high workload periods FMS inputs will be made by the PM, upon the request of PF. Examples of high workload include when flying below 10 000 ft and when within 1000 ft of level off or Transition Altitude.*

*Flight crewmembers shall include scanning of the Flight Mode Annunciator as part of their normal instrument scan, especially when automation changes occur (e.g., course changes, altitude level off, etc.). Changes to the Automated Flight System (AFS)/Flight Management System (FMS) and radio navigation aids during the departure and or approach phases of flight shall be monitored and crosschecked.*

### Take off Briefing during Taxi

The Chapter 10 "taxi" SOP states the following procedure regarding take off briefing during taxi phase:

**PF - TO BRIEFING ..... PERFORM**

- Take off briefing should usually be a brief confirmation of the departure briefing made at the parking bay, and should include any change (RWY, SID...)

- Standard calls

- For significant failure before V1, CAPTAIN will call "STOP" and will take any necessary stop actions.

- Above V1 take off will be continued and no action will be taken except on CAPTAIN command;

- Single Engine procedure is.....

- Acceleration Altitude is.....

- Departure clearance is.....

**CM1 - CABIN REPORT.....OBTAIN FROM CABIN ATTENDANT**

**ALL TAXI C/L .....COMPLETED**

### Take off Checks during Take Off

The Chapter 12 "take off" SOP contains the following procedure before airborne during take off phase:

**CM1 - "TAKE OFF AT XX: XX, V1XXX" ..... ANNOUNCE**

**CM1 - BRAKES ..... RELEASED**

**CM1 - PL 1 + 2 ..... SET IN THE NOTCH**

**CM1 - FMA ..... ANNOUNCE**

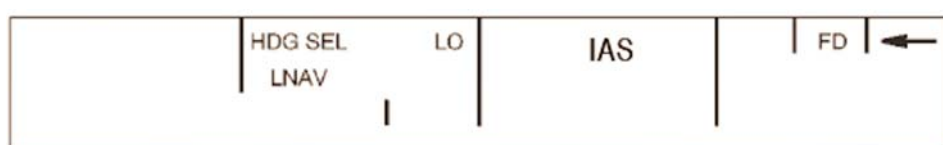

**CM1 - FMA.....CHECK**

**CM2 - “ATPCS ARM” ..... CHECK then ANNOUNCE**

**CM2 - ENGINE PARAMETERS.....CHECK**

*Note: Parameters should be obtained at around 60 Kt*

**ACTUAL TQ ..... MATCH T.O BUG**

*Note: If necessary, adjust PLs to obtain TO TQ (bugs )*

**RTO BUG.....CHECK**

**NP ..... ~ 100 %**

*Note: NP =100 % -- 0.6%I+0.8%*

**ITT .....CHECK**

**CM2 - TO INHIB .....CHECK**

**CM2 - “POWER SET” ..... ANNOUNCE**

**When reaching 70 Kt**

**CM2 - “SEVENTY KNOTS” ..... ANNOUNCE**

**CM1 - SPEED..... CROSS CHECK on PFD**

*And cross check speeds with IESI*

**ALL - “I HAVE CONTROL” / “YOU HAVE CONTROL” ..... ANNOUNCE**

*- If CM1 becomes PF, CM1 announce only “I HAVE CONTROL”*

*- If CM2 becomes PF, CM1 announce “YOU HAVE CONTROL” & CM2 answer “I HAVE CONTROL”*

**PM - “V1” ..... ANNOUNCE**

**When reaching VR:**

**PM - “ROTATE” ..... ANNOUNCE**

**PF - ROTATION .....PERFORM**

*Note: Pitch rotates smoothly and follow FD bar.*

**Communications and Standard Terms**

The Chapter 24 "standard callouts" SOP states the following information regarding communications and terms:

***COMMUNICATIONS AND STANDARD TERMS***

*Standard phraseology is essential to ensure effective crew communication. The phraseology should be concise and exact. The following Chapter lists the callouts that should be used as standard. They supplement the callouts identified in the SOP. These standard ATR callouts are also designed to promote situational awareness, and to ensure crew understanding of systems and their use in line operation.*

**SOP Engine 1(2) Flame Out At Take Off**

The Chapter 25 "memory items" SOP states the following procedure regarding engine 1(2) flame out at take off:

<b><i>ENG 1(2) FLAME OUT AT TAKE OFF</i></b>	
<i>UPTRIM</i> .....	<i>CHECK</i>
<i>AUTOFEATHER</i> .....	<i>CHECK</i>
● <b><i>If no UPTRIM</i></b>	
<i>PL 1 + 2</i> .....	<i>ADVANCE TO THE RAMP</i>
● <b><i>When airborne</i></b>	
<i>LDG GEAR</i> .....	<i>UP</i>
<i>BLEED 1 + 2</i> .....	<i>OFF, IF NOT FAULT</i>
● <b><i>At Acceleration Altitude</i></b>	
<i>ALT</i> .....	<i>SET</i>
● <b><i>At VFTO</i></b>	
<i>PL 1 + 2</i> .....	<i>IN THE NOTCH</i>
<i>PWR MGT</i> .....	<i>MCT</i>
<i>IAS</i> .....	<i>SET</i>



- ***If normal condition***
    - SPD TGT..... CHECK VFTO*
    - FLAPS ..... 0°*
  - ***If icing condition***
    - SPD TGT ..... CHECK VFTO ICING FLAPS 15°*
    - FLAPS ..... MAINTAIN 15°*
- PL affected side..... FI*
- CL affected side..... FTR THEN FUEL SO*
- BLEED engine alive..... OFF if necessary*

**Crew Coordination**

The Chapter 26 "abnormal & emergency proc" SOP states the following information regarding general and crew coordination:

***GENERAL***

*Flight crewmembers shall cope with abnormalities/emergencies by adapting the following principle:*

- *Prioritization: Aviate-Navigate-Communicate*
- *Task Sharing*
- *Division of PF/PM Duties*
- *Crew Coordination*

***IMPORTANT:*** *Never rush up, take all necessary time to analyze situation before acting. No actions (except memo items), no checklists to be performed before acceleration altitude is reached.*

*Continuing to fly the airplane is the single most important consideration in almost every situation.*

**CREW COORDINATION**

*Whenever irregularities occur during flight that have effects on aircraft operation or result in serious failure, the Captain shall immediately take over the control from FOs and serve as PF.*

*PF is responsible for:*

- *power lever*
- *flight path and airspeed control*
- *aircraft configuration*
- *navigation*
- *communications*

*PM is responsible for:*

- *Monitoring and check list reading*
- *execution of required actions*
- *actions on overhead panel*
- *condition lever*

**Rules of Fly**

The Chapter 26 "abnormal & emergency proc." SOP states the following information regarding rules of fly the airplane:

*When an emergency or abnormal situation occurs:*

***FLY THE AIRPLANE.***

*One pilot will devote his/her attention to flying the airplane. When a non-normal situation occurs, the pilot flying (PF) will continue to fly the airplane until properly relieved of that responsibility. It is the captain's (PIC) responsibility to determine who will be the PF for the purposes of situation stabilization and clean-up, and will ensure that both pilots understand who is flying the airplane at all times. The PF will also handle ATC communications as aircraft control permits. Unless the emergency or abnormal procedure directs the pilot to disconnect the auto flight system, It is*

*recommended that it be used as much as possible during these situations.*

**Rules of Failure Identification**

The Chapter 26 "abnormal & emergency proc" SOP states the following information regarding rules of failure identification:

***Failure identification***

*In case of system failure, information is provided to the crew:*

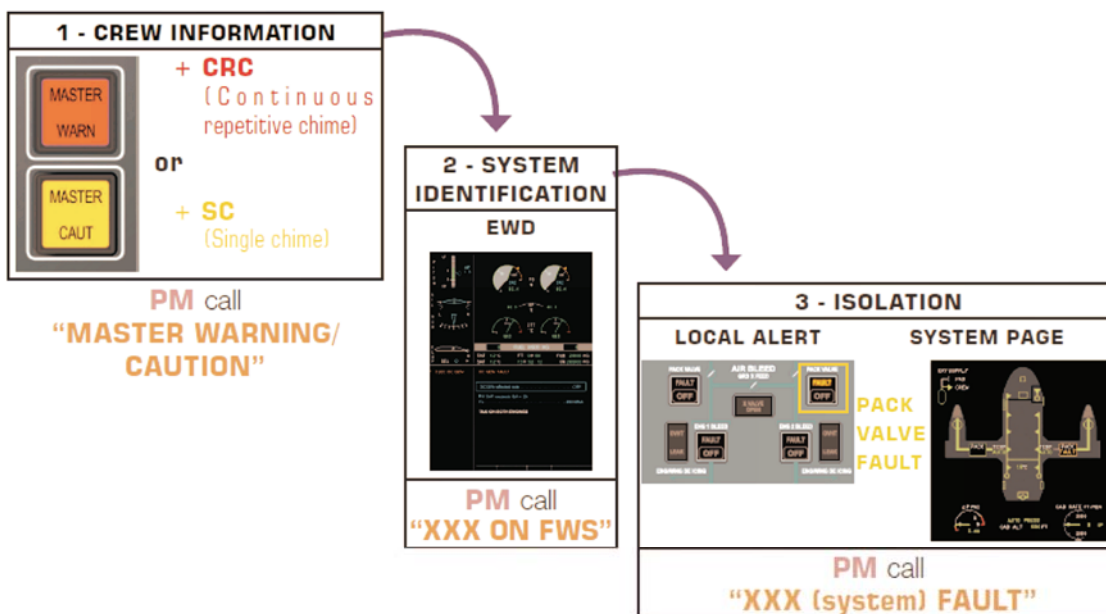

<i>PF</i>	<i>PM</i>
	<p><i>Checks involved flasher and label flashing on EWD</i></p> <p><b>"MASTER WARNING/CAUTION"</b></p> <p><b>"XXX ON FWS"</b></p>
	<p><i> Cancels flashing warning/caution, then checks relevant SD page and lit local alert</i></p> <p><b>"XXX FAULT( OR TYPE OF EVENT)"</b></p>

<p><b>“CHECK”</b></p> <p><i>Acknowledges failure or event identification and when able</i></p> <p><b>“SYSTEM CHECK”</b></p>	
---	--

### **Rejected Take off**

The Chapter 28 "rejected take off" SOP states the following information regarding general and decision management:

#### ***General***

*The decision to reject the take off and the stop action is made by the Captain. It is therefore recommended that the Captain keeps his hand on the power levers until the aircraft reaches V1, whether he/she is Pilot Flying (PF) or Pilot Monitoring (PM). As soon as he/she decides to abort, he/she calls “stop”, takes over control of the aircraft and performs the stop actions. It is not possible to list all the factors that could lead to the decision to reject the take off. However, in order to help the Captain to make a decision, the EWD (CCAS) inhibits the warnings that are not essential from 70kt to 1 500 ft (or 2 min after lift-off, whichever occurs first). Experience has shown that rejected take offs can be hazardous even if the performance is correctly calculated, based on flight tests.*

*This may be due to the following factors:*

- Delay in Performing the stopping procedure*
- Damaged tires*
- Brakes worn, brakes not working correctly, or higher than normal initial brakes temperature*
- The brakes not being fully applied*
- A runway friction coefficient lower than assumed in computations*
- An error in gross weight calculation*

*- Runway line up not considered*

*When the aircraft speed is at or above 70kt, it may become hazardous to reject a take off. Therefore, when the aircraft speed approaches V1, the Captain should be “Go-minded” if none of the main failures quoted below (“Above 70kt and below V1”) have occurred.*

### ***Decision management***

#### ***Below 70kt:***

*The decision to reject the take off may be taken at the Captain’s discretion, depending on the circumstances. Although we cannot list all of the causes, the Captain should seriously consider discontinuing the take off, if any EWD (CCAS) warning/caution is activated.*

*Note: The speed of 70kt is not critical, and was chosen in order to help the Captain make his/her decision and avoid unnecessary stops from high speed.*

#### ***Above 70kt, and below V1:***

*Rejecting the take off at these speeds is a more serious matter, particularly on slippery runways. It could lead to a hazardous situation, if the speed is approaching V1. At these speeds, the Captain should be “go-minded” and very few situations should lead to the decision to reject the take off:*

- 1. Fire warning, or severe damage*
- 2. Sudden loss of engine thrust*
- 3. Malfunctions or conditions that give unambiguous indications that the aircraft will not fly safely*
- 4. Any red warning*

*Exceeding the nose gear vibration should not result in the decision to reject take off above 70kt.*

*In case of tire failure between V1 minus 20 kt and V1:*

*Unless debris from the tires has caused serious engine anomalies, it is far better to get*

*airborne, reduce the fuel load, and land with a full runway length available.*

*The V1 call has precedence over any other call.*

***Above V1:***

*Take off must be continued, because it may not be possible to stop the aircraft on the remaining runway.*

### **1.18.2.3 ATR72-600 Flight Crew Operations Manual**

The current ATR72-600 flight crew operations manual (FCOM) is revision 3, published on 19 January 2015 and accepted by CAA, the contents of FCOM are similar to SOP but more detailed. In addition, this SOP also contains the features of flight operation in TNA. If there is any conflict between the FCOM and the SOP, operators should follow the SOP that plays as the primary indicator of TNA policies. The related paragraphs are shown as below:

#### **Purpose and Engagement of Autopilot**

The part 1, description, "AFCS" contains the following information regarding purpose and auto pilot engagement:

##### **PURPOSE**

*The YAW DAMPER (YD) provides yaw damping, turn coordination and rudder trim function. To achieve these functions, AFCS computers (CAC1/2) and AP yaw actuator are used.*

*The AUTO PILOT (AP) allows the following :*

- *stabilizing the aircraft around its center of gravity while holding pitch attitude and heading, wing level or bank angle (AP in basic modes).*
- *flying automatically any upper or basic mode or anymode except GO AROUND mode which must be flown manually only.*

##### **AUTO PILOT ENGAGEMENT**

*When the AP is engaged, the pitch, roll and yaw actuators are connected to the flight controls, the pitch autotrim and yaw auto trim function are activated.*

- *Engagement with no vertical upper mode selected: The AP flies current pitch attitude. This is the basic vertical mode ("PITCH HOLD", displayed in green). Pitch wheel and TCS can be used to modify the pitch attitude.*
- *Engagement with no lateral upper mode selected: Depending of the conditions at engagement, the AP will level wings and then maintain wing level ("WING LVL", displayed in green) or will maintain the current heading ("HDG HOLD", displayed in green) or will maintain the current bank angle ("ROLL HOLD", displayed in green). These are the basic lateral modes. TCS pb may be used (see 1.04.10).*
- *Engagement with a lateral or vertical armed upper mode selected : the AP flies basic mode until the armed mode becomes active.*
- *Engagement with a lateral and/or vertical active upper mode selected: the AP maneuvers to fly to zero the FD command bars.*
- *If AP is engaged while the vertical FD orders are not followed, the reversion is done in pitch hold mode. (AP basic mode)*

### **General information of AFCS**

The part 2, limitations and procedures, "procedure and techniques" contains the following general information regarding AFCS:

#### **GENERAL**

*The ATR 72 with Mod 5948 is equipped with a Thales AutoPilot/Flight Director.*

*Systematic use of AP/FD is recommended in order to :*

- *Increase the accuracy of guidance and tracking in all weather conditions, from early climb after take off down to landing minima.*
- *Provide increased passenger comfort through SMOOTH AND REPEATABLE altitude and heading changes in all atmospheric conditions.*
- *Reduce crew workload and increase safety.*

### **Flight Characteristics of Stall**

The part 2, limitations and procedures, "procedure and techniques" contains the following stall flight characteristics regarding stall without ice accretion:

### **STALLS**

#### *STALL WITHOUT ICE ACCRETION*

*In all configurations, when approaching the stall, the aircraft does not exhibit any noticeable change in flight characteristics: control effectiveness and stability remains good and there is no significant buffet down to  $CL_{max}$ <sup>61</sup>; this is the reason why both the stall alert (audio "cricket" and shaker) and stall identification (stick pusher) are "artificial" devices based on angle of attack measurement.<sup>62</sup>*

*Recovery of stall approaches should normally be started as soon as stall alert is perceived: a gentle pilot push (togetherwith power increase if applicable) will then allow instantaneous recovery. If the stall penetration attempt is maintained after stall alert has been activated, the STICK PUSHER may be activated: this is clearly unmistakable as the control column is suddenly and abruptly pushed forward, which in itself initiates recovery.*

*Note : The "pushing action" is equivalent to 40daN/88 lbs applied in 0.1 second and it lasts as long as angle of attack exceeds the critical value.*

### **Procedure initiation following failure**

The part 2, limitations and procedures, "procedure following failure" contains the following information regarding procedures initiation:

#### ***Procedures initiation***

*- No action will be taken (apart from depressing MW pb):*

- Until flight path is stabilized.*

---

<sup>61</sup>  $C_L$  max: maximum value of the coefficient of lift. The angle at which maximum lift coefficient occurs is the stall angle of the airfoil.

<sup>62</sup> The angle of attack specifies the angle between the chord line of the wing of a fixed-wing aircraft and the vector representing the relative motion between the aircraft and the atmosphere.



- Under 400 feet above runway (except for propeller feathering after engine failure during approach at reduced power if go around is considered).
- Before performing a procedure, the crew must assess the situation as a whole taking into consideration the failures, when fully identified and the constraints imposed.

**Procedures of Engine 1(2) Flame Out At Take Off**

The part 2, limitations and procedures, "emergency procedures" contains the following procedure regarding engine 1(2) flame out at take off:

**ENG 1(2) FLAME OUT AT TAKE OFF**

**ALERT**

An engine flame out may be recognized by:

- Sudden dissymmetry
- TQ decrease
- Rapid ITT decrease

CONDITION	VISUAL	AURAL
Engine flame out or ATPCS sequence	- MW light flashing red - Associated ENG 1(2) OUT red message on EWD + AUTO FTR and UPTRIM labels on EWD	CRC

**PROCEDURE**

<b>ENG 1(2) FLAME OUT AT TAKE OFF</b>	
UPTRIM .....	CHECK
AUTOFEATHER .....	CHECK
● <b>If no UPTRIM</b>	
PL 1 + 2 .....	ADVANCE TO THE RAMP
● <b>When airborne</b>	
LDG GEAR .....	UP
BLEED 1 + 2 .....	OFF, IF NOT FAULT
● <b>At Acceleration Altitude</b>	

<i>ALT</i> .....	<i>SET</i>
● <b><i>At VFTO</i></b>	
<i>PL 1 + 2</i> .....	<i>IN THE NOTCH</i>
<i>PWR MGT</i> .....	<i>MCT</i>
<i>IAS</i> .....	<i>SET</i>
● <b><i>If normal condition</i></b>	
<i>SPD TGT</i> .....	<i>CHECK VFTO</i>
<i>FLAPS</i> .....	<i>0°</i>
● <b><i>If icing condition</i></b>	
<i>SPD TGT</i> .....	<i>CHECK VFTO ICING FLAPS 15°</i>
<i>FLAPS</i> .....	<i>MAINTAIN 15°</i>
<i>PL affected side</i> .....	<i>FI</i>
<i>CL affected side</i> .....	<i>FTR THEN FUEL SO</i>
<i>BLEED engine alive</i> .....	<i>OFF if necessary</i>

### **Procedures of Recovery after stall**

The part 2, limitations and procedures, "emergency procedures" contains the following procedure regarding recovery after stall or abnormal roll control:

<b><i>RECOVERY AFTER STALL OR ABNORMAL ROLL CONTROL</i></b>	
<i>CONTROL WHEEL</i> .....	<i>PUSH FIRMLY</i>
● <b><i>If flaps 0° configuration</i></b>	
<i>FLAP</i> .....	<i>15°</i>
<i>PWR MGT</i> .....	<i>MCT</i>
<i>CL 1 + 2</i> .....	<i>100% OVRD</i>
<i>PL 1 + 2</i> .....	<i>NOTCH</i>
<i>ATC</i> .....	<i>NOTIFY</i>

● ***If flaps are extended***

<i>PWR MGT</i> .....	<i>MCT</i>
<i>CL 1 + 2</i> .....	<i>100% OVRD</i>
<i>PL 1 + 2</i> .....	<i>NOTCH</i>
<i>ATC</i> .....	<i>NOTIFY</i>

*Note: This procedure is applicable regardless the LDG GEAR position is (DOWN or UP).*

**1.18.2.4 ATR Flight Crew Training Manual**

The flight crew training manual (FCTM) provided by ATR is an essential tool to learn the ATR standard operating procedures. It has been conceived as the standard baseline for all ATR flight crew training. The manual was published in February 2014.

The "emergency procedures" contains the following procedure regarding engine 1(2) flame out at take off:

In the following, PF is seated on the right side. The procedure below starts at the controls transfer.

Flight events	PM	PF
		<p>► <b>CALL</b></p> <p><b>"MY CONTROL"</b></p> <p>Control through rudder pedals and control wheel &amp; column.</p>
<p><b>REACHING V1</b></p>	<p>► <b>CALL</b></p> <p><b>"V1"</b></p> <div style="border: 1px solid black; padding: 2px; width: fit-content; margin: 5px auto;"> <p><b>CM1</b></p> </div> <p>► <b>DO</b></p> <p>PL 1 &amp; 2 ..... RELEASE</p>	
<p><b>REACHING VR</b></p>	<p>► <b>CALL</b></p> <p><b>"ROTATE"</b></p>	<p>► <b>DO</b></p> <p>PITCH ..... ROTATE TO 8°</p> <p>FD BARS ..... FOLLOW</p>
<p><b>ENGINE FLAME OUT</b></p>	<p>First CM who detects the engine failure calls loudly <b>"ENGINE FAILURE"</b></p> <p>The detection clues are:</p> <p><b>PF:</b> Unexpected roll and dissymmetric handling</p> <p><b>PM:</b> abnormal engine parameters (TQ decrease, rapid ITT decrease)</p> <p>And the other CM acknowledges with <b>"CHECK"</b></p>	
<p><b>POSITIVE RATE</b></p>	<p>► <b>CALL</b></p> <p><b>"POSITIVE RATE"</b></p> <p>► <b>DO &amp; CALL</b></p> <p>UPTRIM ENG 2 (or 1) ..... CHECK</p> <p>AUTOFEATHER ENG 1 (or 2) ..... CHECK</p> <p>LANDING GEAR ..... UP</p> <p>YAW DAMPER ..... ENGAGE</p> <p>TAXI &amp; T.O. LIGHTS ..... OFF</p> <p>BLEEDS FAULT ..... CHECK</p> <p>ILLUMINATED</p> <p><b>"UPTRIM, AUTOFEATHER, GEAR UP, BLEEDS FAULT LIT"</b></p>	<p>► <b>ORDER</b></p> <p><b>"ENGINE FLAME OUT AT TAKE-OFF MEMO ITEMS"</b></p> <p>► <b>COMMAND</b></p> <p><b>"GEAR UP"</b></p> <p>If no UPTRIM, PF orders PL 1 &amp; 2 to the ramp.</p> <p>If bleed fault not illuminated, order BLEED 1 (or 2) OFF.</p> <p>If YD can not be engaged, use rudder trim first and then engage YD</p> <p>► <b>CALL</b></p> <p><b>"RADIO RIGHT SIDE"</b></p> <p>► <b>TRANSMIT</b></p> <p><b>"MAYDAY, MAYDAY, MAYDAY, (CALL SIGN), ENGINE FLAME OUT, I'LL CALL YOU BACK"</b></p> <p><b>"SPEED VFTO MAGENTA"</b></p>
<p><b>PASSING ACCELERATION ALTITUDE</b> (mini 400 ft AAL or higher if requested)</p>	<p>► <b>CALL</b></p> <p><b>"ACCELERATION ALTITUDE"</b></p> <p>► <b>DO &amp; CALL</b></p> <p>FGCP: ALT ..... SET</p> <p><b>"ALT GREEN"</b></p> <p>► <b>DO</b></p> <p>FMA MODE ..... CHECK</p>	<p>► <b>COMMAND</b></p> <p><b>"SET ALT"</b></p> <p>► <b>CALL</b></p> <p><b>"CHECK"</b></p> <p>► <b>DO &amp; CALL</b></p> <p>FMA MODE ..... CHECK</p> <p><b>"SPEED VFTO MAGENTA"</b></p>

Flight events	PM	PF
<p><b>REACHING VFTO</b></p>	<p>▶ <b>CALL</b></p> <p style="text-align: center;"><b>"VFTO"</b></p> <p>▶ <b>DO &amp; CALL</b>                      PL 1 &amp; 2 ..... CHECK IN THE NOTCH                      PWR MGT ..... MCT                      TQ / NP ..... CHECK / ADJUST  <b>"MCT SET"</b></p> <p>▶ <b>DO &amp; CALL</b>                      FGCP: IAS MODE ..... ENGAGE  <b>"IAS SET"</b></p> <p>▶ <b>DO</b>                      FLAPS ..... AS RQRD</p>	<p>▶ <b>DO, CALL &amp; COMMAND</b>                      PL 1 &amp; 2 ..... CHECK IN THE NOTCH  <b>"PL IN THE NOTCH, SET MCT"</b></p> <p>▶ <b>COMMAND</b></p> <p style="text-align: center;"><b>"SET IAS"</b></p> <p>▶ <b>COMMAND</b></p> <p style="text-align: center;"><b>"NORMAL CONDITIONS, FLAPS 0"</b>                      or  <b>"ICING CONDITIONS, MAINTAIN FLAPS 15"</b></p>
<p><b>FLAPS 0/15° ON INDICATOR</b></p>	<p>▶ <b>CALL</b></p> <p style="text-align: center;"><b>"FLAPS 0"</b> Normal conditions  <b>"MAINTAIN FLAPS 15"</b> Icing conditions</p>	
<p><b>FLIGHT PATH STABILIZED</b></p>	<p>▶ <b>DO &amp; CALL</b>                      PL POINTED AT BY PF ..... CHECK  <b>"CONFIRM"</b></p> <p>▶ <b>DO &amp; CALL</b>                      CL 1 (or 2) ..... POINT  <b>"CL 1 (OR 2)?"</b></p> <p>▶ <b>DO &amp; CALL</b>                      CL 1 (or 2) ..... FTR then FUEL S.O.  <b>"FEATHER, FUEL SHUT-OFF"</b>                      Shut-off step by step. Stay 1 sec in FTR position before setting CL to Fuel S.O.</p> <p>▶ <b>DO &amp; CALL</b>                      BLEED 1 (or 2) ..... POINT  <b>"BLEED ENGINE ALIVE OFF, YES OR NO?"</b>                      If necessary, remaining BLEED can be deselected to increase climb performance.</p> <p>▶ <b>CALL</b></p> <p style="text-align: center;"><b>"MEMO ITEMS COMPLETE"</b></p> <p>▶ <b>CALL &amp; READ</b>  <b>"ENGINE FLAME OUT AT TAKE-OFF CHECKLIST?"</b>                      Refer to EWD C/L</p> <p>▶ <b>CALL</b>  <b>"ENG FLAME OUT AT TAKE-OFF CHECKLIST COMPLETE"</b></p>	<p>▶ <b>DO &amp; CALL</b>                      PL 1 (or 2) ..... POINT  <b>"PL 1 (OR 2)?"</b></p> <p>▶ <b>DO &amp; CALL</b>                      PL 1 (or 2) ..... RETARD GENTLY TO FI  <b>"FLIGHT IDLE"</b></p> <p>▶ <b>DO &amp; CALL</b>                      CL POINTED AT BY PM ..... CHECK  <b>"CONFIRM"</b></p> <p>▶ <b>DO &amp; CALL</b>                      BLEED POINTED AT BY PM ..... CHECK  <b>"NO" (or "YES")</b></p> <p>▶ <b>REQUIRE</b>  <b>"ENGINE FLAME OUT AT TAKE-OFF CHECKLIST"</b></p>
<p><b>ENGINE FLAME OUT AT TAKE-OFF CHECKLIST COMPLETE</b></p>	<p>▶ <b>CALL &amp; READ</b></p> <p style="text-align: center;"><b>"AFTER TAKE-OFF 1 EO CHECKLIST"</b>                      Refer to EWD C/L  <b>"AFTER TAKE-OFF 1 EO CHECKLIST COMPLETE"</b></p>	<p>▶ <b>REQUIRE</b></p> <p style="text-align: center;"><b>"AFTER TAKE-OFF 1 EO CHECKLIST"</b></p> <p>▶ <b>REQUIRE</b></p> <p style="text-align: center;"><b>"SINGLE ENG OPERATION CHECKLIST"</b>                      Continue with Single Engine operation.</p>

### **1.18.2.5 ATR72-600 Minimum Equipment List and Configuration Difference List**

The current ATR72-600 minimum equipment list and configuration difference list (MEL/CDL) is revision 1 and was published on 10 February 2014. It is developed from the ATR Master MEL revision 05 and ATR72-212A AFM revision 15, and then be tailored to TNA specific operational requirements. It was approved by CAA. The MEL paragraphs related to propellers are shown in Appendix 9.

### **1.18.2.6 Songshan Airport Departure Aeronautical Chart**

The aeronautical information publication (AIP) Taipei FIR is published by the CAA. The Songshan Airport RCSS MUCHA TWO departure chart is shown in Figure 1.18-1.

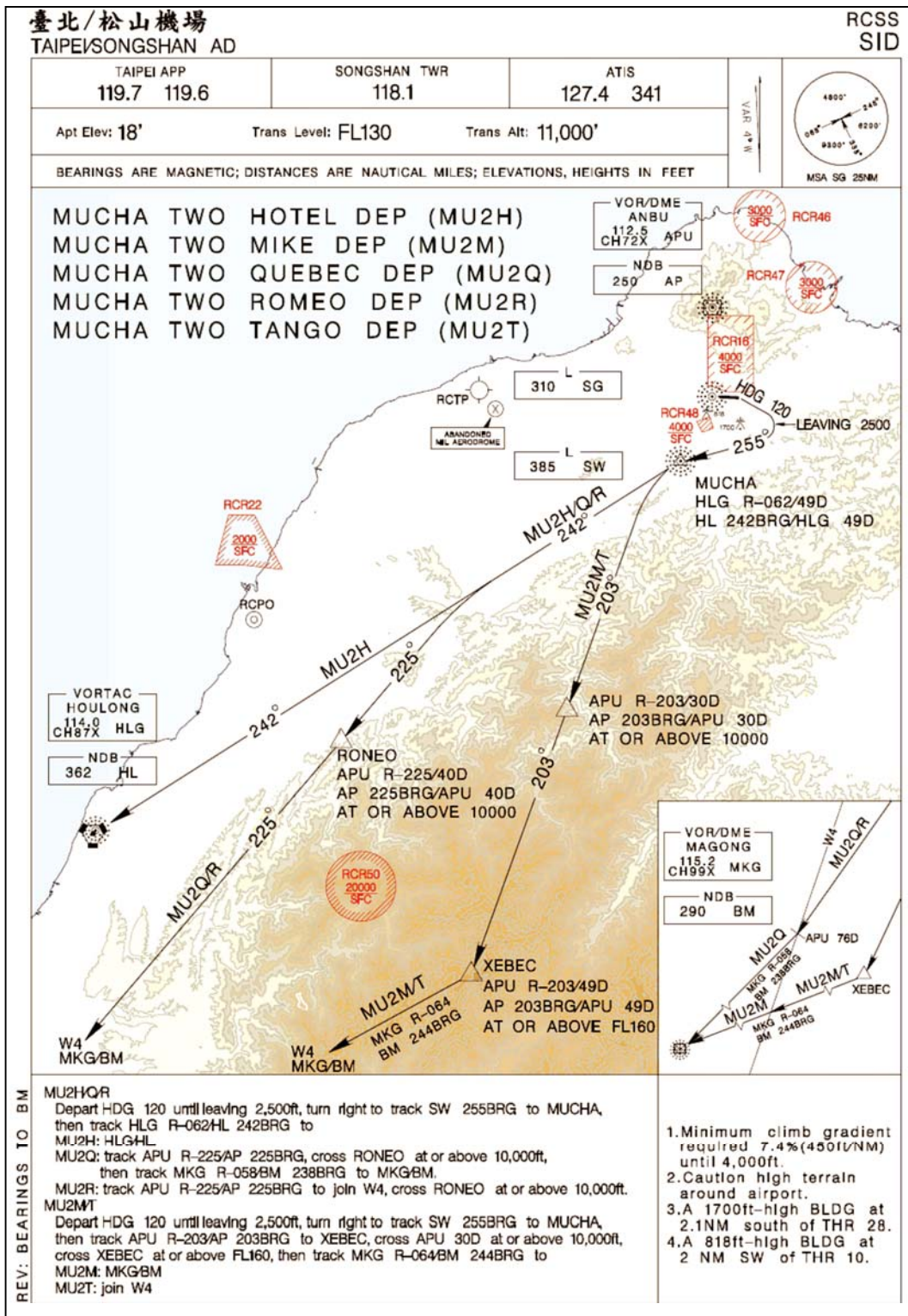

Figure 1.18-1 RCSS MUCHA TWO departure chart

### **1.18.3 Interview Summaries**

#### **1.18.3.1 TNA Flight Crew Interviews**

The investigation's flight operations group interviewed 12 TNA ATR flight crew after the GE235 occurrence. The interviewees included:

- Four ATR72-500 IPs/CPs;
- Two ATR72-600 IPs/CPs;
- Two ATR72-600 Captains;
- Four ATR72-600 First Officers.

The interview notes were divided into 9 topics and summarized as follows:

#### **Abort take off policy while ATPCS not armed during take off roll**

Most of the interviewees stated that ATR72-600 flight crew should abort the take off if the ATPCS was not armed during the take off roll. In the same situation, ATR72-500 flight crew can continue the take off if the calculated ATPCS take off weight was below the RTOW limitation. However, some ATR72-500 interviewees preferred to disregard the above company policy and abort the take off regardless of the take off weight.

#### **ATPCS dynamic test**

Only a few interviewees were able to correctly recall that the ATPCS dynamic test should be conducted at the end of the last flight of each day. Some ATR72-500 interviewees stated that the ATPCS dynamic test was unnecessary for an ATR72-500 aircraft. Most interviewees agreed that the dynamic test was rarely conducted by flight crew. One interviewee stated that he learned about the ATPCS dynamic test from the ATR72-600 differences training course and tried to conduct it in line operations. However, some captains refused to do it because they preferred to finish duty early.

#### **Crew coordination for control of power levers and condition levers**

With regard to ATR72-600 operations, most interviewees stated that they followed



the instructions provided at the ATR72-600 differences training. The PF was responsible for the power levers and the PM was responsible for the condition levers in abnormal or emergency situations. One ATR72-600 interviewee stated that both the power and condition levers should be controlled by pilot flying in line operations.

With regard to ATR72-500 operations, there are several different statements for this issue.

### **Crew resource management (CRM)**

Most of the interviewees were unable to share what they had learned from CRM training. There were some introductory cases used in CRM recurrent training but the instructor did not design scenarios to facilitate discussion of a specific situation by crews.

Some senior captains did not consider that the use of standard call-outs were important and preferred to use gestures instead of call-outs. Some first officers would attempt to challenge a captain's SOP non-compliance behavior but would not insist in correcting it. In addition, several interviewees did not want to report SOP non-compliance behavior via the company's safety reporting system because they do not trust the system.

### **ATR72-600 differences training**

A few ATR72-600 interviewees who had flown other glass cockpit aircraft stated that the 5-days difference training was adequate. Others stated that it was not adequate, especially for FMS and electronic displays familiarization. Most ATR72-600 interviewees stated that longer lead time periods prior to the differences training would have been helpful for learning, such as the conduct of ATR72-600 observation flights, more full-time self-study courses (at least one week), and a mentoring program by experienced and current ATR72-600 pilots. Interviewees also indicated that TNA had arranged about 7 days for self-study prior to the differences training. However, most of the self-study time was shortened to 2-3 days because of support flight duties.

**One engine flameout at take off**

Most of the interviewees stated that the scenario of one engine flameout at take off in simulator training was initiated just as the aircraft lifted off the ground before the autopilot was engaged. In the simulator, the IPs required trainees to perform the procedures step by step and not rush to complete the procedures.

**Autopilot engagement issue**

Most of the ATR72-500 interviewees stated that the autopilot will disengage automatically in the event of an engine flameout because of the abrupt yawing moments. However, the ATR72-600 interviewees stated that the autopilot will not disengage automatically in the event of an engine flameout. Furthermore, they also indicated that the ATR72-600 aircraft had a more powerful rudder auto-trim function so an excessive application of rudder was not necessary to correct directional deviations. Excessive rudder inputs could result in the yaw damper disengaging. One ATR72-600 interviewee stated that he may manually disengage the autopilot in the event of an engine flameout even if the autopilot did not disengage automatically. Some interviewees stated that ATR instructors taught them not to disengage the autopilot because it could reduce the workload.

**Comments on GE235 flight crew**

Most of the interviewees made positive comments about the GE235 flight crew. The pilots who flew with Captain A or Captain B within one week of the occurrence stated that their behavior and condition was normal in flight.

One IP who conducted part of Captain A's upgrade training had commented "a little nervous during line operations and had a tendency of rushing to perform the procedures without coordination with the PM."

**ATR fleet manpower problem**

A few interviewees stated that TNA should increase training requirements and

standards for flight safety. In recent years, several senior ATR first officers were transferred to the Airbus fleet. It was also expressed that TNA salaries cannot attract high quality pilots from elsewhere. This limited TNA's recruiting options and tended to result in less experienced first officers being upgraded to captain.

### **1.18.3.2 Maintenance Division Assistant Manager**

The interviewee introduced TNA's maintenance difficulty reporting procedures and how difficulties were reported. TNA's maintenance control center (MCC) collected the reported aircraft defects from all stations and compiled them into a daily report. These defects might be from pilot reports, safety department or maintenance personnel etc. A daily report was generated and used for reference during TNA's directors meetings. MCC assisted each division's directors to review the daily report as necessary. If there were service difficulty items, MCC would report the items to the quality control center (QCC). The QCC was also required to submit service difficulty reports (SDR) and report the difficulty to the Civil Aeronautics Administration (CAA). After the SDR was reported to the CAA, TNA's reliability control board (RCB) would discuss the solution with CAA personnel.

Regarding aircraft diversions resulting from engine problems during the occurrence aircraft's ferry flight from Bangkok to Taiwan, the interviewee expressed how those engine problems were reported to Taiwan CAA. While the aircraft was in cruise from Toulouse to Taipei, a low oil pressure warning on the ENG 1 occurred. The flight crew shut down the ENG 1 and diverted to Macau Airport. TNA replaced the ENG 1 so the aircraft could continue the delivery flight. During the flight from Macau to Taipei, the ENG 1 low oil pressure warning appeared again and the flight crew shut down the ENG 1 and diverted to Kaohsiung Airport. The investigation confirmed that the missing drive shaft/spur gear woodruff key of the ENG 1 reduction gearbox oil scavenge pump was the cause of the engine low oil pressure warning. Due to repeated ENG 1 low oil pressure warnings and the commanded in flight shut down events, CAA

sent a principal maintenance inspector (PMI) to Kaohsiung Airport to assist TNA.

When asked about TNA's response to in flight shut down events in the last 5 years, the interviewee replied that two of those in flight shut down events occurred during aircraft deliveries and were mentioned earlier. Another engine in flight shut down event occurred on 2 May 2012 and was the result of a manufacturing defect in the engine turbine blades which had been investigated and closed by the ASC. An uncommanded autofeather event occurred on 16 August 2011 and was the result of defective J1 and J2 AFU connectors. TNA revised the ATR continuous airworthiness maintenance program (CAMP) task number 771362-RAI-10000-TNA to change the AFU inspection to a hard time interval. The last in flight shutdown occurred on 6 October 2010 and was due to engine torque fluctuations after takeoff. To address the loss of engine torque signal or torque fluctuations, TNA issued Engineering Circular EC-1106-04 requesting compliance with documents and procedures related to electrical connector care.

### **1.18.3.3 Maintenance Personnel Stationed at Kinmen Airport**

The interviewee has worked for TNA since 1995. He holds CAA A/E/AV<sup>63</sup> maintenance engineer licenses and is stationed at Kinmen Airport as a senior mechanic. The interviewee received ATR72-500 type training and configuration differences course training for the ATR72-500 and -600 aircraft. The interviewee also received aviation maintenance-related recurrent training each year. The interviewee then described the procedures for authorizing and dispatching aircraft after the completion of required checks and maintenance

When asked what maintenance work had been performed on the occurrence aircraft before it was returned to service to operate the sector from Kinmen to Songshan, the sector before the occurrence flight, the interviewee stated the following. There were two mechanics stationed at Kinmen Airport. Mechanics that did not hold a

---

<sup>63</sup> Airframes, engines, avionics.

CAA license performed the aircraft refueling work and the interviewee did the transit check alone. The interviewee finished the transit check in 20 minutes and no faults were found. Usually, if no fault was found, the transit check could be done in about 20 to 25 minutes. The interviewee also checked the maintenance records. There were no deferred defects for the aircraft. The interviewee then signed the Technical Log Book and the aircraft was released for service. After the refueling was completed, the interviewee walked to the cockpit and gave the fuel form to the captain. The flight crew did not mention any problem about the engines.

When a fault was identified before aircraft departure, he did not feel any pressure to release an aircraft if it were to delay an aircraft's scheduled departure. The interviewee said that aircraft airworthiness was the first priority.

#### **1.18.3.4 Maintenance Personnel Stationed at Songshan Airport**

The interviewee has worked for TNA since 2005. Before that he had worked for Dragonair for 2.5 years. He holds CAA's A/E/AV licenses, and is stationed at Songshan Airport as a mechanic. The interviewee had received ATR72-500 type training and configuration differences course training for the ATR72-500 and -600 aircraft. The interviewee also received aviation maintenance-related recurrent training each year. The interviewee then described the maintenance procedures for dispatching an aircraft after the completion of required checks and maintenance.

The transit check before the occurrence flight was done by the interviewee. The transit check was completed in 20 minutes with no fault found. The interviewee expressed that if no fault was found, a transit check would usually be done in about 20 minutes. The interviewee also checked the occurrence aircraft's maintenance records and no deferred defects were found. The interviewee then signed the Technical Log Book and the aircraft was released to service.

The interviewer asked if the flight crew had mentioned anything about an engine problem before the occurrence flight on the sector from Songshan to Kinmen. The

interviewee replied that the first leg of that day was flight GE231. The interviewee conducted a pre-flight check while the captain performed a 360 degree (walk around) check. The pre-flight check result was normal. Before flight GE235, the interviewee conducted the transit check himself. The flight crew did not mention anything about the engine. If there were any faults found before aircraft departure, the interviewee never bargained with the flight crew to apply the MEL to delay maintenance. He did not feel any pressure to release an aircraft if it were to delay an aircraft's scheduled departure. The interviewee said that aircraft airworthiness was the first priority.

#### **1.18.3.5 Songshan Tower Local Controller**

The interviewee commenced the local controller's shift at 1030 hours and described the workload as light to moderate. Around the time of the occurrence, visibility was greater than 10 km but there were some patches of low-level cloud to the east of the airport. Because of an aircraft approaching to land on Runway 10, the crew of GE235 was instructed to hold short of the runway. GE235's entry to the runway to take off was normal. The interviewee then instructed GE235 to change frequency to Taipei Approach after climbing through 1,000 feet just after passing the end of the runway. The local controller then directed her attention to the other aircraft and vehicles under her control after the GE235 pilot read back the instructions and everything continued as normal. Afterwards, Taipei Approach called "tower transfer TransAsia two tree five again" via loud speaker and GE235 called her simultaneously. The sound from the loud speaker was louder so the interviewee didn't hear what the pilot said through her headphones. The interviewee instructed GE235 to contact Taipei Approach again because she thought there was a communication problem but no answer was received. Taipei Approach asked her if she could see the aircraft. She then observed the departure route but found nothing. Afterwards she discovered that the tracking of the occurrence flight on the radar display did not coincide with the normal flight path of the Mucha departure and there was no indication of the aircraft's altitude.

Taipei Approach couldn't contact GE235 either so the interviewee began to call the aircraft several times but got no response. Because the occurrence flight situation was unknown at that point, she informed Taipei Approach and the supervisor of the situation. Her supervisor instructed her to suspend takeoff and landing operations and to proceed with accident notification procedures.

### **1.18.3.6 Songshan Tower Supervisor**

The interviewee was on duty from 0800 hours to 1800 hours. Before the occurrence, he was undertaking administrative tasks and his workload was light. His colleagues were working normally. While the local controller was performing ATC duties, he heard from the loudspeaker (on the right of the local controller and front right side of him) that there was no contact from GE235 and Taipei Approach had requested the local controller to transfer the aircraft again. He immediately got up to look for the traffic, and asked for the takeoff status of the occurrence aircraft. The local controller replied that the aircraft had taken off. The interviewee roughly remembered the position of the occurrence flight on the radar display (but it was not stable), and he was not very sure about this. In addition to the runway extension lines, he also observed the whole airport area, but he could not locate the occurrence flight. He immediately requested the local controller to call the aircraft on channel 118.1 continuously, while he called the emergency channel and observed the airport and its surroundings with a telescope. There was still no reply from GE235 during the broadcast so the interviewee considered this situation as an emergency and instructed the local controller to stop the next aircraft entering the runway for take off, and to continue the observations and broadcasts. At that time, there was a controller undertaking familiarization training beside him, so he asked that controller to inform the tower chief on the 4th Floor. The Tower Supervisor instructed his colleagues to suspend aircraft movements and clear the airspace because the status of GE235 was unknown. He then examined the airport and its surroundings again by telescope, and

asked a colleague to notify the Flight Operations Office to conduct a runway inspection to see if the runway could still be operational.

The visibility was more than 10 kilometers as per the weather report at that time, but he observed the clouds were not very high. After the airport resumed normal operations for takeoff and landing, departing aircraft disappeared from sight (in clouds) within one minute from the take off roll.

#### **1.18.4 Abnormal Engine Torque Related Events/Information**

##### **1.18.4.1 Chronology of TNA ATR72 Abnormal Engine Torque Related Events/Information**

A review of Taiwan CAA's aviation incident reports revealed that two TNA ATR72 abnormal engine torque-related events were investigated between October 2010 and the day of the GE235 occurrence. One was related to the connection between the torque sensor and the EEC and the other event was related to the AFU. There was also a TNA ATR72 autofeather event after the GE235 occurrence. A chronology of these events and applicable information is shown in Table 1.18-1.

Table 1.18-1 TNA ATR72 abnormal engine torque related events

Date	Type of aircraft or Info issued by	Description of event/information
Nov. 17, 2008	P&WC	P&WC issued Service Information Letter SIL No. PW100-125 to operators on proper electrical connector protection and wrapping.
Oct. 06, 2010	ATR72-500	After take off, ENG 2 torque vibrated between 20% and 100%, the aircraft turned back and landed safely. The connection between No. 2 torque sensor and EEC was suspected.
Jun. 28, 2011	TNA	TNA issued Engineering Circular EC-1106-04 to Line/Base Maintenance and Training Section to re-iterate the importance of practicing appropriate connector care during any engine connector installation. The Flight Operations Division added Abnormal Engine Parameters in Flight procedure into the ATR FLEET Training Program.



Aug. 16, 2011	ATR72-500	During cruise, ENG 1 torque dropped to zero causing the pilot to shut down ENG 1. The ENG 1 was then restarted and aircraft landed safely. P&WC report confirmed that a defect found in the AFU caused the uncommanded autofeathering of ENG 1.
Mar. 15, 2012	TNA	TNA issued Engineering Circular EC-1203-03 to inform related departments of the information in the P&WC report, including the associated symptoms.
Feb. 21, 2015 <sup>64</sup>	ATR72-500	After take off, ENG 1 torque dropped causing ENG 1 propeller to autofeather. The aircraft turned back and landed safely.

#### 1.18.4.2 Related Service Information Issued by P&WC

On 15 August 2007, P&WC issued Service Bulletin SB21742 which advised operators to perform a one-time inspection of AFUs. SB21742 was issued to address the aging of AFU electrical connectors and the interconnect ribbon solder joints that could lead to loss of torque signal and subsequent autofeather. Later in August 2007, P&WC issued SB21742R1 (see Appendix 10) which recommended that operators send their AFUs to an authorized accessory shop to conduct the one-time inspection per the latest CMM instructions. In December 2009, P&WC moved the content of SB21742R1 in Table 4 of section 05-20-00 of the engine maintenance manual (P/N 3037332, rev. 42) and changed this inspection to a repeat inspection. P&WC then cancelled SB21742 in April 2011 because the maintenance requirements were now contained in the engine maintenance manual.

On 14 December 2010, P&WC issued service information letter (SIL) No. PW100-138 for AFU inspection/repair at shop visits. The document indicated that some of the AFUs involved in those autofeather events exhibited cracks in the soldering of the U3 voltage converter mounted on the AFU board. Those cracks were believed to have caused momentary electrical disruptions leading to the autofeather events. The manufacturer of the AFU then revised instructions regarding the U3 converter inspection, installation and soldering to its mounting board. In addition,

<sup>64</sup> Incident date of this event was after the date of GE235 occurrence (4 Feb. 2015).

testing requirements for the AFU were improved via testing at low, high and ambient temperatures.

On 26 September 2011, P&WC issued Service Information Letter No. PW100-147<sup>65</sup> for AFU-related autofeather events. The document indicated that several of the reported autofeather events were associated with 28 Volts DC power interruptions at the AFU. On ATR aircraft, those power interruptions generate large magnitude torque bug fluctuations. The AFU manufacturer has incorporated related content into its CMM which included:

- Revised instructions for U3 converter inspection, installation and soldering on the mounting board;
- Inspections related to the J1 and J2 flex conductors and boards interconnect flexible ribbons; and
- Functionality testing of the AFU at different temperatures (low, high and ambient).

On 29 October 2012, P&WC issued service bulletin SB21822 that introduced an AFU with low pass filters. On 12 May 2014 P&WC issued SB21858 that introduced an improved AFU with longer solder filled joints of the J2 connector flex circuit assembly.

#### **1.18.4.3 Emergency Airworthiness Directive**

After the occurrence, the Taiwan Civil Aeronautics Administration issued an emergency airworthiness directive (AD number CAA-2015-02-013E) on 25 February 2015. On the following day, the revised version was issued (see Appendix 11). The AD was applicable ATR72-500 and ATR72-600 fleets. The AD was issued to address the uncommanded autofeather events. The AD quoted two operations engineering bulletins (OEB) issued by ATR (Appendix 12). These two OEBs were "Uncommanded auto-feather - 500" and "Uncommanded auto-feather - 600" and contained similar

---

<sup>65</sup> The PW100-147 was expired on 26 September 2012.

content. The emergency AD required operators to amend the affected sections of their quick reference handbooks (QRH) in accordance with the instructions contained in the ATR OEBs. The recommended changes to operational procedures in the OEB included:

*a. Take off normal procedure*

*At take off, the ATPCS must be checked armed and announced. If it is not armed while both power levers are in the notch, or in the case of intermittent arming / disarming of the ATPCS, the take off must be rejected.*

*b. Any loss of NP and/or TQ should be dealt with as an engine failure*

*i. During Take off*

*ENG FLAME OUT AT TAKE OFF procedure is applicable.*

*ii. During any other phase of flight*

*Apply the following procedure:*

*PL affected side .....FI*

*CL affected side .....FTR THEN FUEL SO*

*LAND ASAP*

*SINGLE ENG OPERATION procedure (2.05).....APPLY*

## **1.18.5 Propulsion System Malfunction and Inappropriate Crew Response**

### **1.18.5.1 Overview of PSM+ICR Study**

Following an accident in the U.S. in December 1994<sup>66</sup>, the U.S. Federal Aviation

---

<sup>66</sup> Flight Safety Foundation. (1996). Commuter captain fails to follow emergency procedures after suspected engine failure, loses control of the aircraft during instrument approach. *Accident Prevention*, 53 (4), 1-12.

Administration (FAA) requested the Aviation Industries Association (AIA) to conduct a review of serious incidents and accidents that involved an engine failure or perceived engine failure and an ‘inappropriate’ crew response. The AIA conducted the review in association with the European Association of Aerospace Industries (AECMA) and produced their report in November 1998.<sup>67</sup>

The review examined all accidents and serious incidents worldwide which involved ‘Propulsion System Malfunction + Inappropriate Crew Response (PSM+ICR)’. Those events were defined as ‘where the pilot(s) did not appropriately handle a single benign engine or propulsion system malfunction’. Inappropriate responses included incorrect response, lack of response, or unexpected and unanticipated response. The review focused on events involving western-built commercial turbofan and turboprop aircraft in the transport category. The review conclusions included the following:

- The rate of occurrences per airplane departure for PSM+ICR accidents had remained essentially constant for many years. Those types of accidents were still occurring despite the significant improvement in propulsion system reliability that has occurred over the past 20 years, suggesting that the rate of inappropriate crew response to propulsion system malfunction rates had increased.
- As of 1998, the number of accidents involving PSM+ICR was about three per year in revenue service flights, with an additional two per year associated with flight crew training of simulated engine-out conditions.
- Although the vast majority of propulsion system malfunctions were recognized and handled appropriately, there was sufficient evidence to suggest that many pilots have difficulty identifying certain propulsion system malfunctions and reacting appropriately.
- With specific reference to turboprop aircraft, pilots were failing to properly

---

<sup>67</sup> Sallee, G. P. & Gibbons, D. M. (1999). Propulsion system malfunction plus inappropriate crew response (PSM + ICR). *Flight Safety Digest*, 18, (11-12), 1-193.

control the airplane after a propulsion system malfunction that should have been within their capabilities to handle.

- The research team was unable to find any adequate training materials on the subject of modern propulsion system malfunction recognition.
- There were no existing regulatory requirements to train pilots on propulsion system malfunction recognition.
- While current training programs concentrated appropriately on pilot handling of engine failure (single engine loss of thrust and resulting thrust asymmetry) at the most critical point in flight, they do not address the malfunction characteristics (auditory and visual cues) most likely to result in inappropriate response.

#### **1.18.5.2 Turboprop Aircraft**

Of the 75 turboprop occurrences with sufficient data for analysis, about 80% involved revenue flights. PCM+ ICR events in turboprop operations were occurring at  $6 \pm 3$  events per year. About half of the accidents involving turboprop aircraft in the transport category occurred during the take off phase of flight. About 63% of the accidents involved a loss of control, with most of those occurring following the propulsion system malfunction during take off. Seventy percent of the ‘powerplant malfunction during take off’ events led to a loss of control, either immediately or on the subsequent approach to land.

Propulsion system failures resulting in an uncommanded total power loss were the most common technical events. ‘Shut down by crew’ events included those where either a malfunction of the engine occurred and the crew shut down the engine, or where one engine malfunctioned and the other (wrong) engine was shut down. Fifty percent of the ‘shut down by crew’ events involved the crew shutting down the wrong engine, half of which occurred on training flights.

#### **1.18.5.3 Failure Cues**

The report’s occurrence data indicated that flight crews did not recognize the

propulsion system malfunction from the symptoms, cues, and/or indications. The symptoms and cues were, on occasion, misdiagnosed resulting in inappropriate action. In many of the events with inappropriate actions, the symptoms and cues were totally outside of the pilot's operational and training experience base.

The report stated that to recognize powerplant malfunctions, the entry condition symptoms and cues need to be presented during flight crew training as realistically as possible. When these symptoms and cues cannot be presented accurately, training via some other means should be considered. The need to accomplish failure recognition emerges from analysis of accidents and incidents that were initiated by single powerplant failures which should have been, but were not, recognized and responded to in an appropriate manner.

While training for engine failure or malfunction recognition is varied, it often involved pilot reaction to a single piece of data (one instrument or a single engine parameter), as opposed to assessing several data sources to gain information about the total propulsion system. Operators reported that there was little or no training given on how to identify a propulsion system failure or malfunction.

There was little data to identify which cues, other than system alerts and annunciators, the crews used or failed to use in identifying the propulsion system malfunctions. In addition, the report was unable to determine if the crews had been misled by aircraft systems, displays, other indications, or each other where they did not recognize the powerplant malfunction or which powerplant was malfunctioning.

#### **1.18.5.4 Effect of Autofeather Systems**

The influence of autofeather systems on the outcome of the events was also examined. The "loss of control during take off" events were specifically addressed since this was the type of problem and flight phase for which autofeather systems were designed to aid the pilot. In 15 of the events, autofeather was fitted and armed (and was therefore assumed to have operated). In five of the events, an autofeather system was

not fitted and of the remaining six, the autofeather status is not known. Therefore, in at least 15 out of 26 events, the presence of autofeather failed to prevent the loss of control. This suggests that whereas autofeather is undoubtedly a benefit, control of the airplane is being lost for reasons other than excessive propeller drag.

#### **1.18.5.5 Training Issues**

In early generation jet and turboprop aircraft flight engineers were assigned the duties of recognizing and handling propulsion system anomalies. Specific training was given to flight engineers on these duties under the requirements of CFR Part 63 - Certification: Flight Crew Members Other than Pilots, Volume 2, Appendix 13. To become a pilot, an individual progressed from flight engineer through co-pilot to pilot and all pilots by this practice received powerplant malfunction recognition training. The majority of pilots from earlier generations were likely to see several engine failures during their careers, and failures were sufficiently common to be a primary topic for discussion. It was not clear how current generation pilots learned to recognize and handle propulsion system malfunctions.

At the time of the report, pilot training and checking associated with propulsion system malfunctions concentrated on emergency checklist items which were typically limited, on most aircraft, to engine fire, in-flight shutdown and re-light, and, low oil pressure. In addition, the training and checking covered the handling task following engine failure at or close to V1. Pilots generally were not exposed in their training to the wide range of propulsion system malfunctions that can occur. No evidence was found of specific pilot training material on the subject of propulsion system malfunction recognition on modern engines.

There's a broad range of propulsion system malfunctions that can occur, and the symptoms associated with those malfunctions. If the pilot community is, in general, only exposed to a very limited portion of that envelope, it is probable that many of the malfunctions that occur in service will be outside the experience of the flight crew. It

was the view of the research group that, during basic pilot training and type conversion, a foundation in propulsion system malfunction recognition was necessary. This should be reinforced, during recurrent training with exposure to the extremes of propulsion system malfunction; e.g., the loudest, most rapid, most subtle, etc. This, at least, should ensure that the malfunction was not outside the pilot's experience, as was often the case.

The report also emphasized that "Although it is important to quickly identify and diagnose certain emergencies, the industry needs to effect cockpit/aircrew changes to decrease the likelihood of a too-eager crew member in shutting down the wrong engine". In addition, the report also noted that negative transfer has also been seen to occur since initial or ab-initio training was normally carried out in aircraft without autofeather systems. Major attention was placed on the need for rapid feathering of the propeller(s) in the event of engine failure. On most modern turboprop commercial transport airplanes, which are fitted with autofeather systems, this training can lead to over-concentration on the propeller condition at the expense of the more important task of flying the airplane.

Furthermore, both negative training and transfer were most likely to occur at times of high stress, fear and surprise, such as may occur in the event of a propulsion system malfunction at or near the ground.

Loss of control may be due to a lack of piloting skills or it may be that preceding inappropriate actions had rendered the aircraft uncontrollable regardless of skill. The recommended solutions (even within training) would be quite different for these two general circumstances. In the first instance, it is a matter of instilling through practice the implementation of appropriate actions without even having to think about what to do in terms of control actions. In the second instance, there is serious need for procedural practice. Physical and mental workload can be very high during an engine failure event.



### **1.18.5.6 Training Recommendations**

The report made a number of recommendations to improve pilot training. With specific reference to turboprop pilot training, the report recommended:

- Industry provide training guidelines on how to recognize and diagnose the engine problem by using all available data in order to provide the complete information state of the propulsion system.
- Industry standardized training for asymmetric flight.
- Review stall recovery training for pilots during take off and go-around with a focus on preventing confusion during low speed flight with an engine failure.

### **1.18.5.7 Error types**

Errors in integrating and interpreting the data produced by propulsion system malfunctions were the most prevalent and varied in substance of all error types across events. This might be expected given the task pilots have in propulsion system malfunction (PSM) events of having to integrate and interpret data both between or among engines and over time in order to arrive at the information that determines what is happening and where (i.e., to which component). The error data clearly indicated that additional training, both event specific and on system interactions, is required.

#### **Data integration**

The same failure to integrate relevant data resulted in instances where action was taken on the wrong engine. These failures to integrate data occurred both when engine indications were changing rapidly, that is more saliently, as well as when they were changing more slowly over time.

#### **Erroneous assumptions**

A second category of errors related to interpretation involved erroneous assumptions about the relationship between or among aircraft systems and/or the misidentification of specific cues during the integration/interpretation process. Errors

related to erroneous assumptions should be amenable to reduction, if not elimination, through the types of training recommended by the workshop. Errors due to misidentification of cues need to be evaluated carefully for the potential for design solutions.

### **Misinterpretation of cues**

A third significant category of errors leading to inappropriate crew responses under “interpret” was that of misinterpretation of the pattern of data (cues) available to the crew for understanding what was happening and where in order to take appropriate action. Errors of this type may be directly linked to failures to properly integrate cue data because of incomplete or inaccurate mental models at the system and aircraft levels, as well as misidentification of cues. A number of the events included in this subcategory involved misinterpretation of the pattern of cues because of the similarity of cue patterns between malfunctions with very different sources.

### **Crew communication**

A fourth error category involved the failure to obtain relevant data from crew members. The failure to integrate input from crew members into the pattern of cues was considered important for developing recommendations regarding crew coordination. It also highlighted the fact that inputs to the process of developing a complete picture of relevant cues for understanding what is happening and where can and often must come from other crew members as well as from an individual’s cue-seeking activity. This error type was different to “not attending to inputs from crew members”, which would be classified as a detection error.

### **System knowledge**

Knowledge of system operation under non-normal conditions was inadequate or incomplete and produced erroneous or incomplete mental models of system performance under non-normal conditions. The inappropriate crew responses were

based on errors produced by faulty mental models at either the system or aircraft level.

### **Improper strategy and/or procedure and execution errors**

The selection of an inappropriate strategy or procedure featured prominently in the events and included deviations from best practice and choosing to reduce power on one or both engines below a safe operating altitude. Execution errors included errors made in the processing and/or interpretation of data or those made in the selection of the action to be taken.

#### **1.18.6 U.S. Army ‘Wrong Engine’ Shutdown Study**

The United States (U.S.) Army conducted a study (‘The Wrong Engine Study’)<sup>68</sup> to see if pilots’ reactions to single-engine emergencies in dual-engine helicopters were a systemic problem and whether the risks of such actions could be reduced. The goal was to examine errors that led to pilots to shutting down the wrong engine during such emergencies.

The research involved the use of surveys and simulator testing. Over 70 % of survey respondents believed there was the potential for shutting down the wrong engine and 40 % confirmed that they had, during actual or simulated emergency situations, confused the power control levers (PCLs). In addition, 50% of those who recounted confusion confirmed they had shut down the "good engine" or moved the good engine’s PCL. When asked what they felt had caused them to move the wrong PCL, 50% indicated that their action was based on an incorrect diagnosis of the problem. Other reasons included the design of the PCL, the design of the aircraft, use of night vision goggles (NVG), inadequate training, negative habit transfer, rushing the procedure and inadequate written procedures. When asked how to prevent pilots from selecting the wrong engine, 75% recommended training solutions and 25% engineering

---

<sup>68</sup> Wildzunas, R.M., Levine, R.R., Garner, W., and Braman, G.D. (1999). *Error analysis of UH-60 single-engine emergency procedures* (USAARL Report No. 99-05). Fort Rucker, AL: U.S. Army Aeromedical Research Laboratory.

solutions.

The simulator testing (n=47) found that 15% of the participants reacted incorrectly to the selected engine emergency and 25% of the erroneous reactions resulted in dual engine power loss and simulated fatalities. Analysis of reactions to the engine emergencies identified difficulties with the initial diagnosis of a problem (47%) and errors in action taken (32%). Other errors included the failure to detect system changes, failure to select a reasonable goal based on the emergency (get home versus land immediately), and failure to perform the designated procedure. The range of responses included immediately recognizing and correcting the error to shutting down the "good" engine, resulting in loss of the helicopter. Although malfunctions that require single-engine emergency procedures were relatively rare, the study indicated that there was a one in six likelihood that, in these types of emergencies, the crew will respond incorrectly.

The pattern of cognitive errors was very similar to the PSM+ICR error data. The functions contributing to the greatest number of errors were diagnostic (interpretation) and action (execution). The largest difference was in the major contribution of strategy/procedure errors in the PSM+ICR database, whereas there were comparatively few goal, strategy, and procedure errors in the U.S. Army simulator study. The survey data indicated that pilots felt that improper diagnosis and lack of training were major factors affecting their actions on the wrong engine. This supported the findings of the PSM+ICR report that included the need for enhanced training to improve crew performance in determining what is happening and where.

## **1.18.7 Additional Human Factors considerations**

### **1.18.7.1 Diagnostic skills**

Diagnostic skills are recognized as having important implications for operators of

complex socio-technical systems, such as aviation<sup>69</sup>. The development of advanced technologies and their associated interfaces and displays have highlighted the importance of cue acquisition and utilization to accurately and efficiently determine the status of a system state before responding appropriately to that situation. Moreover, cue-based processing research has significant implications for designing diagnostic support systems, interfaces, and training<sup>70</sup>. In addition, miscuing<sup>71</sup> and/or poorly differentiated cues have been implicated in several major aircraft accidents, including Helios Airways Flight 522 and Air France Flight 447<sup>72,73</sup>. It has also been argued that cue-based associations comprise the initial phase of situational awareness<sup>74</sup>. Furthermore, it has been demonstrated that individuals and teams with higher levels of cue utilization have superior diagnostic skills and are better equipped to respond to non-normal system states<sup>75</sup>.

The ‘PSM+ICR’ study identified recurring problems with a crew’s diagnosis of propulsion system malfunctions, in part, because the cues, indications, and/or symptoms associated with the malfunctions were outside of the pilot’s previous training and experience. Consistent with the U.S. Army study, that often led to confusion and inappropriate responses, including shutting down the operative engine.

### **1.18.7.2 Situational Awareness**

Situational awareness (SA) is a state of knowledge which is achieved through

---

<sup>69</sup> Wiggins, M. W. (2015). Cues in diagnostic reasoning. In M. W. Wiggins and T. Loveday (Eds.), *Diagnostic expertise in organizational environments* (pp. 1-13). Aldershot, UK: Ashgate.

<sup>70</sup> Wiggins, M. W. (2012). The role of cue utilization and adaptive interface design in the management of skilled performance in operations control. *Theoretical Issues in Ergonomics Science*, 15, 1-10.

<sup>71</sup> Miscuing refers to the activation of an inappropriate association in memory by a salient feature, thereby delaying or preventing the accurate recognition of an object or event.

<sup>72</sup> Loveday, T. (2015). Designing for diagnostic cues. In M.W. Wiggins and T. Loveday (Eds.), *Diagnostic expertise in organizational environments* (pp. 49-60). Aldershot, UK: Ashgate.

<sup>73</sup> Perry, N. (2015). Diagnostic support systems. In M.W. Wiggins and T. Loveday (Eds.), *Diagnostic expertise in organizational environments* (pp. 113-122). Aldershot, UK: Ashgate.

<sup>74</sup> O’Hare, D. (2015). Situational awareness and diagnosis. In M. W. Wiggins and T. Loveday (Eds.), *Diagnostic expertise in organizational environments* (pp. 13-26). Aldershot, UK: Ashgate.

<sup>75</sup> Loveday, T., Wiggins, M. W., & Searle, B. J. (2013). Cue utilization and broad indicators of workplace expertise. *Journal of Cognitive Engineering and Decision-Making*, 8, 98-113.

various situation assessment processes<sup>76</sup>. This internal model is believed to be the basis of decision-making, planning, and problem solving. Information in the world must be perceived, interpreted, analyzed for significance, and integrated with previous knowledge, to facilitate a predictive understanding of a system's state. SA is having an accurate understanding of what is happening around you and what is likely to happen in the near future. Team SA is the degree to which every team member possesses the SA required for their responsibilities<sup>77</sup>.

The three stages in SA formation have traditionally included:

- Perception of environmental elements (important and relevant items in the environment must be perceived and recognized. It includes elements in an aircraft such as system status, warning lights and elements external to an aircraft such as other aircraft, obstacles);
- The comprehension of their meaning; and
- The projection of their status following a change in a variable (with sufficient comprehension of the system and appropriate understanding of its behavior, an individual can predict, at least in the near term, how the system will behave. Such understanding is important for identifying appropriate actions and their consequences).

Dominguez et al. (1994)<sup>78</sup> proposed that SA comprised the following four elements:

- Extracting information from the environment;

---

<sup>76</sup> Endsley, M.R. (2004). Situation awareness: Progress and directions. In S. Banbury & S. Tremblay (Eds.), *A cognitive approach to situation awareness: Theory and application* (pp. 317–341). Aldershot, UK: Ashgate Publishing.

<sup>77</sup> Endsley, M. R. & Jones, W. M. (2001). A model of inter- and intrateam situation awareness: Implications for design, training and measurement. In M. McNeese, E. Salas & M. Endsley (Eds.), *New trends in cooperative activities: Understanding system dynamics in complex environments*. Santa Monica, CA: Human Factors and Ergonomics Society.

<sup>78</sup> Dominguez, C. (1994). Can SA be defined? In M. Vidulich, C. Dominguez, E. Vogel, & G. McMillan, *Situation awareness: Papers and annotated bibliography* (pp. 5-16). Wright-Patterson AFB, OH: Armstrong Laboratory.

- Integrating this information with relevant internal knowledge to create a mental picture of the current situation;
- Using this picture to direct further perceptual exploration in a continual perceptual cycle; and
- Anticipating future events.

Many factors can induce a loss of situational awareness. Errors can occur at each level of the process. Table 1.18-2 lists a series of factors related to loss of situational awareness, and conditions contributing to those errors<sup>79</sup>.

A loss of situational awareness could occur when there was a failure at any one of these stages resulting in the pilot and/or crew not having an accurate mental representation of the situation.

---

<sup>79</sup> Flight Safety Foundation. (2009). Crew resource management. *Operator's guide to human factors in aviation*. Alexandria, VA: Author. Also see [http://www.skybrary.aero/index.php/Situational\\_Awareness\\_%28OGHFA\\_BN%29](http://www.skybrary.aero/index.php/Situational_Awareness_%28OGHFA_BN%29).

Table 1.18-2 Factors involved in loss of situational awareness

- Data are not observed, either because they are difficult to observe or because the observer's scanning is deficient due to:
  - Attention narrowing
  - Passive, complacent behavior
  - High workload
  - Distractions and interruptions
  - Visual Illusions
- Confirmation bias:
  - Information is misperceived. Expecting to observe something and focusing attention on that belief can cause people see what they expect rather than what is actually happening.
- Use of a poor or incomplete mental model due to:
  - Deficient observations
  - Poor knowledge/experience

Use of a wrong or inappropriate mental model, over-reliance on the mental model and failing to recognize that the mental model needs to change.

Human operators may interpret the nature of the problem incorrectly, which leads to inappropriate decisions because they are solving the wrong problem (an SA error) or operators may establish an accurate picture of the situation, but choose an inappropriate course of action (error of intention).

Endsley (1999) reported that perceptual issues accounted for around 80% of SA errors, while comprehension and projection issues accounted for 17% and 3% of SA errors, respectively. That the distribution of errors was skewed to perceptual issues likely reflected that errors at Levels 2 and 3 will lead to behaviors (e.g., misdirection of



attentional resources) that produce Level 1 errors<sup>80</sup>.

St. John and Smallman (2008)<sup>81</sup> noted that SA is negatively affected by interruptions and multi-tasking. One of the difficulties of maintaining SA was to recover from a reallocation of cognitive resources as tasks and responsibilities change in a dynamic environment. In many respects, interruptions and multi-tasking introduce conditions for change blindness<sup>82</sup> or problems with cue acquisition, understanding and utilization.

For a pilot, situational awareness means having a mental picture of the existing inter-relationship of location, flight conditions, configuration and energy state of the aircraft as well as any other factors that could be about to affect its safety such as proximate terrain, obstructions, airspace, and weather systems. The potential consequences of inadequate situational awareness include CFIT, loss of control, airspace infringement, loss of separation, or an encounter with wake vortex turbulence.

There is a substantial amount of aviation related situational awareness research. Much of this research supports loss of situational awareness mitigation concepts. These include the need to be fully briefed, in order to completely understand the particular task at hand. That briefing should also include a risk management or threat and error management assessment. Another important mitigation strategy is distraction management. It is important to minimize distraction, however if a distraction has occurred during a particular task, to back up a few steps, and check whether the intended sequence has been followed.

---

<sup>80</sup> Endsley, M. R. (1999). Situation awareness in aviation systems. In J. A. Wise, V. D. Hopkin, V. D., & D. J. Garland, (Eds.), *Handbook of aviation human factors* (pp. 257-275). Mahwah, NJ: Lawrence Erlbaum.

<sup>81</sup> St. John, M. S., & Smallman, H. S. (2008). Staying up to speed: Four design principles for maintaining and recovering situation awareness. *Journal of Cognitive Engineering and Decision Making*, 2, 118-139.

<sup>82</sup> Change blindness is the striking failure to see large changes that normally would be noticed easily. See Simons, D. J., & Rensink, R. A. (2005). Change blindness: Past, present, and future. *Trends in Cognitive Sciences*, 9, 16-20.

### 1.18.7.3 Stress

Stress can be defined as a process by which certain environmental demands evoke an appraisal process in which perceived demand exceeds resources and results in undesirable physiological, psychological, behavioral or social outcomes. This means if a person perceives that he or she is not able to cope with a stressor, it can lead to negative stress reactions. Stress can have many effects on a pilot's performance. These include cognitive affects such as narrowed attention, decreased search activity, longer reaction time to peripheral cues and decreased vigilance, and increased errors performing operational procedures<sup>83,84,85,86,87</sup>.

Stress management techniques include simulator training to develop proficiency in handling non-normal flight situations that are not encountered often and the anticipation and briefing of possible scenarios and threats that could arise during the flight even if they are unlikely to occur (e.g. engine failure). These techniques help prime a crew to respond effectively should an emergency arise.

---

<sup>83</sup> Salas, E., Driskell, J. E., & Hughes, S. (1996). Introduction: The study of stress and human performance. In J. E. Driskell & E. Salas (Eds.), *Stress and Human Performance* (pp. 1-46). Mahwah, N.J.: Lawrence Erlbaum.

<sup>84</sup> Salas, E., Driskell, J. E., and Hughes, S. (1996). Introduction: The study of stress and human performance. In J. E. Driskell and E. Salas (Eds.) *Stress and human performance*. Mahwah, New Jersey: Lawrence Erlbaum Associates.

<sup>85</sup> Hancock, P. A., & Szalma, J. L. (2007). Stress and performance. In P. A. Hancock, & J. L. Szalma (Eds.), *Performance under stress* (pp. 1-18). Aldershot, UK: Ashgate.

<sup>86</sup> Hancock, P. A., and Warm, J.S. (1989). A dynamic model of stress and sustained attention. *Human Factors*, 31, 519-538.

<sup>87</sup> Boag-Hodgson, C. (2010). Topic 12: Stress. *ATSB human factors course* (pp.1-12). Canberra, ACT: ATSB.

Intentionally left blank

## Chapter 2 Analysis

### 2.1 General

The flight crew were properly certificated and qualified in accordance with applicable Civil Aviation Regulations, Republic of China. There was no evidence to indicate that the flight crew's performance might have been adversely affected by pre-existing medical conditions, fatigue, medication, other drugs or alcohol during the occurrence flight. Visual meteorological conditions (VMC) prevailed at the time of the aircraft's departure. No adverse weather conditions were present for the flight.

The analysis addresses safety issues associated with aircraft airworthiness, flight operations, including crew training, and human factors issues, such as crew resources management. The GE222 investigation had identified specific areas for improvement in the TNA's safety management processes and effectiveness of CAA's regulatory surveillance activities so they will not be discussed further in this analysis. Those safety issues were still being addressed at the time of the GE235 occurrence.

### 2.2 Airworthiness

#### 2.2.1 Aircraft Systems and Powerplant

The aircraft's certificate of airworthiness and registration were current at the time of the occurrence. The occurrence aircraft was dispatched at Songshan Airport with no known defects and was in compliance with all applicable Airworthiness Directives and Service Bulletins. A review of the aircraft's maintenance records before the occurrence flight revealed that there were no defects reported that related to ENG 2 automatic feathering system.

The wreckage examination indicated that the aircraft damage was the result of impact forces. Post-impact examination of the engines indicated no pre-existing anomalies affecting their normal operation. However, the CVR and FDR data indicated that ATPCS had not armed during the initial stage of the take off roll but then indicated

that it had armed later in the take off roll. During the initial climb an uncommanded autofeather of the ENG 2 occurred.

The ATPCS, AFU, and related components were examined and tested. Torque signal continuity relevant items including wiring harnesses and torque sensors were also checked. The continuity of wiring harnesses were checked normal. Among the four torque sensors<sup>88</sup> that were examined, the left torque sensor of ENG 2 which connected to AFU No.2 was found a coil winding open circuit. The X-ray analysis (see Figure 1.16-10) of the sensor indicated that the coil wires had broken at the outside of the bend due to the impact.

The AFU examination results indicated that the compromised soldering joints inside ENG 2 AFU which formed part of the connection between ENG 2 torque sensor and the AFU No.2 had increased an unstable signal path resistance, therefore, may have produced an intermittent discontinuity of the torque signal. Continuity of the signal was required to ensure that the ATPCS system functioned as expected. The disrupted signal probably resulted in the uncommanded autofeather.

### **2.2.2 ATPCS and Uncommanded Autofeather**

The purpose of the ATPCS was to automatically feather the propeller during take off in the case of engine failure, and then increase engine power (uptrim) to the opposite operating engine. The ATPCS monitors both engine torque signals, when one engine decreased below 18.5 percent rated torque it indicates the engine failure. Arming of the ATPCS also required that torque signal on both engines was greater than 46%. The operation of the ATPCS would be rendered unreliable if the torque signals transmitted to the system were disrupted intermittently or otherwise.

Post-impact testing of AFU No.2 revealed that the resistance exceeded the CMM threshold. The measured resistance values for pins J and H, which were the connecting

---

<sup>88</sup> Each engine contained two torque sensors, the No. 1 (left) and No. 2 (right) sensor. The left torque sensor is connected to the AFU and the right torque sensor is connected to the EEC.

points between the torque sensor and AFU, fluctuated and were higher than the prescribed values in CMM when the ribbon was moved by hand. Intermittent signal discontinuity produces an unstable torque signal to AFU and can adversely affect the functioning of the ATPCS, including unreliable arming and inadvertent or uncommanded autofeathering.

At time 1051:43 as recorded by the CVR, the flight crew announced that the ATPCS was "not armed" at take off power initiation. However, the FDR data (see Table 2.1-1) indicated that all the conditions required for arming the ATPCS had been met. The abnormal status can be explained by the discontinuity between the AFU No.2 and the torque sensor. The discontinuity interrupted the torque signal path to the AFU and caused the ATPCS to indicate that it was not armed. Eight seconds later (1051:51), as recorded by the CVR, the flight crew announced that the ATPCS was now ARMED. This symptom was consistent with a temporary discontinuity that persisted for about eight seconds. During the climb through 1,200 feet, as recorded by the CVR and FDR, the master warning sounded associated display of the "ENG 2 FLAMEOUT AT TAKE OFF" procedure, the ATPCS autofeather sequence completed, leading to the uptrim of ENG 1 followed by the feathering of the ENG 2 propeller. However, all of ENG 2's parameters (see Table 2.1-1) were normal before the ATPCS sequence was triggered. This symptom was also consistent with a temporary discontinuity between the AFU No.2 and the torque sensor. The technical events that contributed to the occurrence were all consistent with intermittent discontinuity in the AFU No.2.

Table 2.1-1 FDR data related to ATPCS

Time (hh:mm:ss)	AIR/GND mode	PWR MGT Switch	PLA_N o.1 (deg)	TQ_No.1 (%)	PLA_No.2(deg)	TQ_No.2 (%)
10:51:43	GND	TO	74.9	83.8	74.2	84.7
10:51:52	GND	TO	74.9	89.9	74.2	90.3
10:52:37	AIR	TO	74.9	100.9	74.2	89.6

The intermittent discontinuity of AFU No.2 produced the unstable behavior of the

ATPCS which resulted in the uncommanded autofeather of the ENG 2 propeller.

### **2.2.3 Autofeather Unit Quality**

A few days after the GE235 occurrence, another TNA ATR72 crew experienced an uncommanded autofeather in-flight. That aircraft's AFU (referred to as AFU No. 3) was removed and sent to the manufacturer for test and examination. The results revealed a similar discontinuity problem as found in AFU No.2.

The serial numbers of AFU No.2 and AFU No.3 were RT2362 and RT2354 respectively. The date of manufacturing of these two AFUs was in the same week, the fifteenth week of 2013. The AFUs had been in service since March 2014 and April 2014 respectively and the service periods<sup>89</sup> were less than one year. The similar compromised soldering joints were found in these two units.

The engine manufacturer (P&WC) had been aware of AFU-related technical issues causing uncommanded autofeather events since 2005 and proposed SBs starting from 2007. Investigation of the AFUs from those events revealed that some of the units exhibited cracks in the soldering of the J1 and J2 connectors. Those cracks were believed to have caused momentary electrical disruptions leading to an uncommanded autofeather. In response, the manufacturer issued various service bulletins and service information letters to operators recommending unit modification and/or information to address the AFU-related autofeather events.

SB No.21742 advised that "Aging of the Autofeather Unit (AFU) electrical connectors and interconnect ribbon solder joints can lead to loss of torque signal". The manufacturer recommended implementing the service bulletin actions before the AFU had accumulated 12,000 flight hours, or before 31 July 2010, whichever occurred last. SIL No. PW100-138 and PW100-147 provided further information regarding the converter inspection, installation and soldering to its mounting board. In addition, AFU

---

<sup>89</sup> According to the TNA, the service period of AFU SN RT2362 was from 28 March 2014 to 4 February 2015, SN RT2354 was from 8 April 2014 to 21 February 2015.

testing requirements were improved via testing at different temperatures (low, high and ambient) and vibration testing. These new instructions supplemented the revised instructions introduced for the J1 and J2 connectors and interconnect ribbons testing and inspection. The above maintenance actions were included in the latest CMM version.

With reference to Table 1.16-2, the total flight times of both AFU No.2 and AFU No.3, were 1,624 flight hours and 1,206 flight hours respectively. Compared to the engine manufacturer's recommended inspection time of 12,000 flight hours, these two AFUs' had accumulated time far below the manufacturer's inspection recommendation. This suggested that the causes of intermittent continuity failure of the AFU may not only be related to aging, but also to other previously undiscovered issues. The current technical countermeasures implemented by the engine manufacturer to address the AFU continuity problems were not sufficiently effective and require further solutions. During this occurrence investigation, the engine manufacturer, Pratt & Whitney Canada, informed the investigation team that a product improvement was made to the auto-feather control and is currently implemented into all new production engines. Also, for the existing engines in service, a Service Bulletin, SB21880 (see Appendix 13), was issued in October 2015 to replace the auto-feather control with the improved one.

## **2.3 Flight Operations**

### **2.3.1 ATPCS Policy and Procedures**

After the brakes were released and both power levers were 'SET IN THE NOTCH' and 'FMA'<sup>90</sup> was announced and checked, the TNA ATR72-600 take off standard operating procedures required CM2<sup>91</sup> to check then announce 'ATPCS ARM'.

---

<sup>90</sup> FMA: flight mode annunciator.

<sup>91</sup> CM2: crew member 2. The initial section of the take off SOPs refers to CM1 and CM2. Part way through the checklist the flight crew identification terminology changes to PF and PM when V1 is announced.



As the throttle was advanced for take off in the occurrence flight, Captain B (PM) noticed that the ATPCS was not armed and he responded correctly by announcing that. The PM then announced ‘take off inhibit’ which was confirmed by Captain A (PF) who then decided to continue the take off with the assent of the PM. The CVR indicated that the PM announced that the ATPCS had armed about seven seconds before the aircraft reached V1 speed.

TNA’s ATR72-500 fleet policy permitted flight crews to continue the take off if the ATPCS pushbutton ‘ARM’ light did not lit as long as RTOW had been checked before take off and the operation of the aircraft was modified in accordance with the procedures promulgated by company technical circular No. m1010604x issued in 2012. The TNA flight crew training supervisor informed the investigation that those technical circulars only applied to the -500 aircraft not the -600 aircraft. The company’s ATR72-600 policy required crews to reject the take off if the ATPCS did not ‘ARM’ and crews were trained to perform this procedure. In addition, the ATR72-600 pilots (including IPs, CPs, captains and first officers) who were interviewed also stated that they would abort the take off in such circumstances.

The occurrence flight crew’s decision was not consistent with these expectations. However, there were no documented company policies, instructions, procedures, or notices to crew for ATR72-600 operations communicating the requirement to reject the take off if the ATPCS did not arm. On the contrary, TNA’s ATR72-600 normal check list still required flight crew to check if the aircraft’s MTOW was below the RTOW before take off because that was the criterion for determining if a take off could be continued in the event of the ATPCS not arming. That may have indicated to -600 flight crew that the -500 ATPCS take off procedures in the event of the ATPCS not arming could apply. That discrepancy and potential for confusion had not been identified before the occurrence flight.

As of the date of the occurrence, Captain A and B had accrued 250 and 795 fly hours on the ATR72-600 respectively. They had previously accrued 3,151 and 5,687 fly

hours on the ATR72-500 respectively. They were comparatively new to the -600. It was possible that their practices on the -500 fleet had transferred across to operating the -600. However, there was no evidence the occurrence flight crew reverted substituted other -500 procedures before or after the ATPCS not arming. Therefore, it seemed more likely that the absence of a formal, documented company policy that was enforced and consistent with the reported ATPCS training on the -600 created an opportunity for misunderstanding.

The aircraft manufacturer issued two OEBs, "Uncommanded auto-feather -500" and "Uncommanded auto-feather -600" after the GE235 occurrence. Both OEBs promulgated the same normal take off procedure for ATPCS discrepancies: *"At take off, the ATPCS must be checked armed and announced. If it is not armed while both power levers are in the notch, or in the case of intermittent arming / disarming of the ATPCS, the take off must be rejected."* These two OEBs would have provided a clear directive to TNA that all ATR72-500/600 crews were to reject the take off if they encountered any ATPCS discrepancies.

With reference to TNA ATR72-600 MEL, item 22-2, the ATPCS may be inoperative provided operations were conducted in accordance with the airplane flight manual supplement 7\_02.10: "dispatch with ATPCS off". According to that procedure, the first item was to select ATPCS OFF and bleed valves OFF, which disabled the autofeathering function during take off. Had the pilots rejected the take off in response to the ATPCS not arming, and then re-dispatched the aircraft with "ATPCS OFF" as per the MEL procedure, the subsequent uncommanded autofeather would not have occurred.

### **2.3.2 ATR Rejected Take off Policy**

During the investigation, the ATR provided a statement of the SOP policy regarding the checks performed during take off and focus on ATPCS checks (see Appendix 8). The ATR stated that *the purpose of the Standard Operating Procedures*

*(SOP) is to ensure the aircraft is in the appropriate configuration for all phase of flight, including take-off. By definition, any check not completed halts the procedure and take off cannot proceed. This is the industry norm.* The ATR also provided an Airbus 3xx SOP at take off to show how another manufacturer deals with SOP. It is noted that Airbus does not list all the conditions leading to a rejected take off but write the general policy as an operating technique. However similar information was not documented in ATR's manuals. The implementation of such information or policy announcement in the manufacturer FCOM is required so that a rejected take off procedure may be clarified.

Furthermore, although ATR72 AFM 5.03 has a rejected take off procedure described as an abnormal procedure, it is associated with one engine inoperative condition only, and the rejected take off procedure was not described in the ATR FCOM. It is required to review the manufacturers AFM to ensure that a rejected takeoff procedure is applicable also to both engine operating and should be described as an abnormal procedure in the FCOM.

### **2.3.3 Handling of Emergency Situation**

#### **2.3.3.1 Failure Identification**

At 1052:38.3, when the aircraft commenced the right turn and was climbing through 1,200 feet, the master warning light / sound annunciated in the cockpit and the "ENG 2OUT" red message was displayed on the Engine and Warning Display (EWD). According to TNA's ATR72-600 Abnormal and Emergency SOPs, section 26.1, flight crews were advised to "take all necessary time to analyze situation before acting." With reference to procedures initiation, the ATR72-600 Flight Crew Operating Manual (FCOM) advised that "Before performing a procedure, the crew must assess the situation as a whole, taking into consideration the failures, when fully identified, and the constraints imposed." The priorities were to stabilize the aircraft's flight path and assess the remaining aircraft capabilities.

TNA's ATR72-600 Abnormal and Emergency SOPs provided a failure identification process to assist crews. In response to a "MASTER WARNING/CAUTION" Captain B, as the PM, was to announce the flashing master warning and call out the item flashing on the EWD. That meant that the required initial actions by the PM in the occurrence should have comprised calling 'MASTER WARNING' and 'ENGINE 2 OUT ON FWS'<sup>92</sup> followed by cancellation of the master warning and then announcing the fault or type of event on the systems display page. Captain A, as the PF, was then required to call "Check" after he had acknowledged the failure and when able to call out "SYSTEM CHECK". Six failure analysis checks must be performed for failure confirmation after the PF calls 'SYSTEM CHECK'. However, the CVR transcript and FDR readout indicated that following the master warning, the PM said "take a look". Just as the PM began the failure identification process, approximately 4 seconds after the master warning occurred, the PF retarded the ENG 1 power lever (PL1) to a power lever angle (PLA) of 66.4 degrees and then said "I will pull back engine one throttle". This was consistent with the PF assessing the situation and responding without any input from the PM as per the documented failure identification and confirmation process. Those hasty actions resulted in the cancellation of the uptrimmed power on ENG 1 which reduced the engine's torque from its highest value of 104% to 82%.

The flight crew failed to perform the appropriate failure identification procedure before the PF reduced power on the operative engine. This premature action led to confusion in the cockpit. The PM called for a cross check and an engine flame out check but the PF did not address those items. The PM subsequently called an auto feather and confirmed that ENG 2 flameout but the PF had already retarded PL1 to 22% torque. The aircraft stall warning system then activated and then confusion was prevalent as the PF called the shutdown of ENG 1. By the time the PM announced

---

<sup>92</sup> FWS: flight warning system.

engine flameout on both sides and an engine restart was attempted, the aircraft was at an altitude from which recovery was not possible and a stall and loss of control followed.

### **2.3.3.2 Utilization of Autopilot**

TNA's ATR72-600 Abnormal and Emergency SOPs stated that "unless the emergency or abnormal procedure directs the pilot to disconnect the auto flight system, it is recommended that it be used as much as possible during these situations". The ATR72-600 FCOM also indicated that use of autopilot is recommended in order to reduce crew workload and increase safety.

The FDR indicated that the autopilot was engaged at 1052:16 and it was still engaged when the master warning occurred. The CVR indicated that one second after the master warning sounded, Captain A (PF) called out "I have control". Two seconds later the autopilot was disconnected. There was no call out or conversation between the flight crew about autopilot disengagements. Based on the FDR data and the ATR72 autopilot disengagement logics analysis (see Appendix 14), the Safety Council concluded that the PF disconnected the autopilot when he had taken manual control of the aircraft.

Part 1.04.20 of the ATR72-600 FCOM indicated that when the autopilot was engaged, the pitch, roll and yaw actuators were connected to the flight controls, the pitch auto trim and yaw auto trim function were also activated. This meant that the ATR72-600 auto trim system automatically compensated for the yaw moment induced by an engine failure and back drove the rudder pedals in the cockpit.

As recorded in the FDR, after the autopilot was disengaged, the PF frequently applied trim control. In addition, the speed decreased due to the fact there were no more engine power and that the aircraft was maintained in a climb attitude. When the flight crew tried to follow the engine-out standard instrument departure (EOSID) after the master warning, the aircraft's heading was set to 092 degrees by Captain B (PM),

but the PF continually turned to the left after passing through a heading of 095 degrees. If the autopilot had not been disengaged at this point in the flight, the autopilot would have maintained heading 092 degrees and subsequently reduced the crew's workload.

The PF's decision to disconnect the autopilot shortly after the first master warning increased the PF's subsequent workload and reduced his capacity to assess and cope with the emergency situation.

### **2.3.4 Non-Compliance with Procedures**

TNA's ATR72-600 SOP memory items for an engine number 2 flame out at take off ("ENG 2 FLAME OUT AT TAKE OFF") required the PF to announce the failure, maintain aircraft control at all times and call for "engine flame out at take off memo items." The PM shall confirm and callout that the 'ATPCS UPTRIM' and 'AUTOFEATHER' functions are activated and displayed on the EWD. Landing gear 'UP' and 'BLEED 1 + 2' were to be confirmed if no fault was present. The PF was then to adjust the aircraft's attitude to accelerate to the aircraft's target speed ( $V_{FTO}$ ).

However, the CVR transcript and FDR readout showed that the PF did not command "engine flame out at take off memo items". The PM initiated the memory items and called out "engine flameout check" at 1053:00, which was approximately 22 seconds after the first master warning had annunciated. The PM then verified the activation of the ATPCS sequence and called "check uptrim yes, autofeather yes" at 1053:02.

Instead of adjusting the aircraft's attitude to accelerate to  $V_{FTO}$  as per SOPs, the PF retarded power lever No. 1 (PL1) as indicated by a power lever angle (PLA) reduction from 66.5 to 49.2 degrees between 1053:05 and 1053:07. The aircraft continued to climb and airspeed subsequently decayed even though the PM alerted the PF about the airspeed and called out "okay now number two engine flameout confirmed". The flight crew did not follow the ENG 2 flameout at take off procedures. The FDR readout showed that ENG 1 torque was reduced from 82.2% to 24.4%

between 1053:05 and 1053:12. The power reduction on the operative engine resulted in the airspeed decaying until the stall warning systems, including audio alert, stick shaker, and stick pusher activated several times.

The engine flame out at take off procedures also required that, on completion of relevant memo items and after  $V_{FTO}$  was acquired, the PF could then begin to shut down the affected engine when the flight path was stabilized. However, the CVR and FDR indicated that the stall warnings had activated before  $V_{FTO}$  was acquired but the PF commanded the shutdown of ENG 1. That indicated that the PF skipped several required memory items and attempted to shut down ENG 1 when the flight path was not yet stabilized.

Part 03.02.03 of the ATR FCTM described the detailed crosscheck procedures and standard callouts for shutting down the affected engine. The following actions and callouts were required for shutting down an engine (example used is ENG 2):

- (a) When the flight crew decides to retard the affected side's PL, the PF should point at the affected side's PL and call "PL2?". After being checked by the PM, followed by a response of "confirm", the PF should then retard PL2 gently to the flight idle position and call "flight idle"; and then
- (b) When the flight crew decides to retard the affected side CL, the PM should point at it and call "CL2?". After the PF checks and calls "confirm", the PM should then retard CL2 to the feathered position and then to the fuel shut-off position and call out "feather, fuel shut-off".

During the shutdown of ENG 1, the flight crew used non-standard processes and callouts in a noisy cockpit environment with frequent stall warnings. This deprived the crew of an opportunity to systematically assess and review the situation to ensure that both crewmembers understood that a loss of thrust had occurred on ENG 2.

The CVR and FDR showed that PL1 was further retarded to 34.5 degrees PLA at 1053:18 and CL1 was retarded to the shut off position at 1053:24. The resultant torque on ENG 1 reduced to 0% at 1053:27. The loss of all engine power combined with pitch

attitude led the aircraft angle of attack to reach the stall warnings threshold. Ultimately the aircraft entered a stall from which the crew were unable to recover. The PF's unannounced reductions in power on ENG 1 as a result his confusion regarding the identification and nature of the actual propulsion system malfunction led to the shut down and feathering of ENG 1 propeller. It appeared that the PM had not detected that the PF had once again manipulated PL1. The non-compliance with critical abnormal and emergency SOPs resulted in confusion in the cockpit and led to the operative engine being shut down. Had the crew followed the SOPs they would have increased the likelihood of jointly and correctly identifying the propulsion system malfunction and would have been in a position to restart that engine if there were no symptoms of damage. If the crew had nothing more than confirm the ENG 2 loss of thrust and returned to land using the remaining engine, the occurrence would not have occurred.

The GE222 investigation report had identified that flight crew non-compliance with SOPs was a systemic problem at TNA. Within 7 months of the GE222 accident, the GE235 accident occurred, and non-compliance with procedures were again identified not only during the occurrence flight but in interviews with company pilots.

A summary of non-compliance with SOPs and/or company expectations or non-conformance with safe practices identified during the occurrence flight included:

- Non-compliance with sterile cockpit rule during taxi;
- Did not brief engine out procedure during takeoff briefing;
- Did not comply with the undocumented company expectation to reject the take off if the ATPCS did not arm during the takeoff roll (ATR72-600 only);
- PF unnecessarily disconnected the autopilot after the master warning sounded;
- PF did not positively identify propulsion system malfunction before taking action;
- Crew did not perform the ENG 2 flameout at take off procedure correctly.

The non-compliance with procedures deprived the flight crew of an opportunity to manage the emergency correctly and efficiently. Their actions further complicated the situation, substantially increasing their workload, and a manageable situation



eventuated in a stall and loss of aircraft control. The repetitive and recurring non-compliance with SOPs identified again in this occurrence and by previous ASC investigations of TransAsia Airways ATR accidents (GE222) and serious incidents, indicated that non-compliant behaviors were an enduring, systemic problem and were consistent with a poor safety culture within the airline's ATR fleet. The recommended remedial measures by the airline and CAA were in progress or had not been implemented, and/or were not effective, and/or followed up by the time the GE235 accident had occurred.

### **2.3.5 Aircraft Recovery**

The simulation testing indicated that the time required to restart ENG 1 was about 25 to 30 seconds after the restart procedure was initiated. However, the stall warnings, including the stick pusher activated during the process with an altitude loss of up to 900 feet.

By the time the PF had realized he had shut down the wrong engine (ENG 1) and the crew attempted a restart, the aircraft was at an altitude of approximately 550 feet or 25 seconds to impact, which was insufficient for a successful restart and fly away. The aircraft stalled during the attempted restart at an altitude from which the aircraft could not recover.

During the simulation test (refer to 1.16.2), the investigation team found that the flight director bars provided a nose-up guidance contrary to the stick pusher nose-down inputs in stall test. Although the influence of the flight director indication was not demonstrated in the occurrence flight and the logics of ATR flight director bars are consistent with other aircraft types within the industry, the flight director bars were in contradiction with the inputs to make in this situation and thus may disturb the crew. The Safety Council believes a review of the functional or display logic of the flight director is required at industry level so that it disappears or presents appropriate orders when a stall protection is automatically triggered.

## **2.3.6 Human Factors Perspectives of Flight Crew Performance**

### **2.3.6.1 Flight Crew Performance**

The flight crew could have identified the ENG 2 loss of thrust and maintained control of the aircraft if both crew members had shared a correct understanding and recognition of the propulsion system malfunction. The aircraft had significant performance and control margins and would have had no difficulty climbing clear of obstacles and returning to land on one engine. Furthermore, the SOPs permitted a restart attempt if the crew assessed that the inoperative ENG 2 was not damaged. In that instance, if power to ENG 2 had been restored, the crew would have had both engines operating and no difficulty returning to land.

The flight crew's performance reflected many of the known findings in the "Propulsion System Malfunction + Inappropriate Crew Response (PSM+ICR)" report, U.S. Army study, and other human factors issues identified in the literature. In addition to non-compliance with SOPs, there were:

- significant diagnostic discrepancies between crew members – PF did not recognize the propulsion system malfunction from the symptoms, cues, and/or indications with a resultant misdiagnosis. While the PM identified that ENG 2 had experienced a loss of thrust, he did not detect the subsequent shut down of ENG 1 by the PF, although the CVR indicated that the PM corrected the PF about retarding power lever during the initial stall warning sequence;
- the PF did not assess the several sources of data that were available or utilize the PM effectively in the diagnostic process;
- failures to properly control the aircraft after the initial propulsion system malfunction that should have been within their capabilities to handle;
- areas for improvement in crew training which did not appear to address the malfunction characteristics (auditory and visual cues) most likely to result in inappropriate crew response;

- an uncommanded power loss, which was the most common technical event;
- PF shut down the wrong engine in response to an engine malfunction; and
- the PF was too hasty in his response to the situation.

### **2.3.6.2 Diagnostic Errors**

The flight crew errors prevalent in the occurrence flight reflected the types of errors that occurred in other accidents and included errors in integrating and interpreting the data produced by propulsion system malfunctions were the most prevalent and varied in substance of all error types across events. The error data clearly indicated that additional training, both event specific and on system interactions, is required.

The PM initially appeared to comprehend that the propulsion system malfunction was related to ENG 2 but the PF did not have the same understanding of the situation. Rather, the PF became fixated on ENG 1 and did not respond to the indications on the EWD or the PM's verbalizations regarding ENG 2. The observer did not appear to understand what was happening given that he was still under ATR-600 differences line training for the aircraft even though he was a very experienced pilot overall. All three crew members became confused by what was happening, particularly after both engines ceased operating as a result of the PF shutting down the operative ENG 1. The aircraft entered a stall during the ENG 1 restart attempt. The PF finally realized that he had "pulled back the wrong side throttle" at a point where the aircraft was unrecoverable.

### **2.3.6.3 Stress and Mental Preparation**

In order to minimize the response times and ensure the most appropriate decisions in the event of an emergency, it was a company requirement and an industry practice that pilots conduct a pre-take off briefing. This briefing includes mentally reviewing the emergency procedures and deciding on the conditions of airspeed, height, rate of climb and/or aircraft configuration that must exist in order to continue the flight in the

event of an engine failure. The pilots should endeavor to be mentally prepared to act, so that if an engine failure occurs at a critical stage of flight, an accurate assessment and response to the failure is implemented.

Sudden and unexpected hazardous events are stressful for flight crews<sup>93, 94</sup>. If the flight crew is not able to cope with the stressors, it can lead to negative stress reactions, such as poor awareness, inaccurate decision making, reduced perception, illogical reasoning, low self control, and reduced vigilance<sup>95,96</sup>. Abnormal and emergency SOPs are, in part, designed to provide a methodical means for handling stressful events, including an uncommanded autofeather after takeoff.

Captain A's command upgrade and ATR72-600 differences training records within one year of the occurrence, contained several negative comments by IPs and/or CPs on his understanding and performance of single engine flameout at takeoff procedures. Even though Captain A finally passed the command upgrade and type differences training, there were indications that his ability to handle an engine failure at takeoff was marginal.

The CVR indicated that Captain A (PF) did not brief or review the engine failure procedure during the take off briefing or the company expectation that the take off should be rejected if the ATPCS failed to arm in the ATR72-600 during take off. The crew were not as mentally prepared as they could have been for the autofeather condition they had encountered in the absence of a pre-take off briefing. In addition, thorough system knowledge of the ATPCS may have indicated to the crew that its failure to arm earlier during the take off roll could be an indication of a more serious

---

<sup>93</sup> Civil Aviation Authority. (2014, October). *CAP 731-Flight Crew Human Factors Handbook*. London, UK: CAA.

<sup>94</sup> Strauch, B. (2002). *Investigating human error: Incidents, accidents, and complex systems*. Aldershot, UK: Ashgate.

<sup>95</sup> "Stress and Stress Management" article included in the *Operator's Guide to Human Factors in Aviation* (2009), Flight Safety Foundation.

<sup>96</sup> P.A. Hancock and J.L. Szalma. Chapter 1 Stress and Performance. *Performance Under Stress* published by Ashgate Publishing Limited, 2007.

problem.

Captain A's marginal ability to handle an engine failure at take off, under stress, and lack of mental preparation for the occurrence flight may have had a bearing on:

- Captain A misidentifying ENG 1 as the malfunctioning engine even though Captain B announced ENG 2 flameout;
- Captain A omitting several required items in the single engine flameout procedure and diverted his attention to ENG 1 throttle; and
- Maintaining an appropriate airspeed not only for single engine operations but also above the stall with both engines inoperative. Captain A did not detect that airspeed was approaching the stall.

#### **2.3.6.4 Flight Crew Training and Competency Issues**

After retiring from the military, Captain A had joined another local airline in September 2009 as a trainee first officer on the A330. His A330 initial transition training records indicated that he had difficulty on multi-tasking, prioritizing, making correct decisions, and performing under stress. After remedial training, his performance remained unsatisfactory and his training was discontinued in March 2010.

Captain A subsequently joined TNA in August 2010. He successfully completed initial ATR72-500 first officer training, and the subsequent recurrent proficiency training and checks. In April 2014, he met the criteria to be considered for command upgrade selection. His performance during the selection process was marginal. Captain A successfully completed his ground school and simulator sessions during the upgrade training but failed the final simulator check in May 2014. The unsatisfactory items were abnormal engine start, both hydraulic systems loss, and single engine approach go-around. The check airman's comments indicated: incomplete procedure check and execution; and insufficient knowledge of emergency procedures.

After further training, Captain A passed the recheck in June 2014, and was promoted to Captain in July 2014. During his subsequent line training, certain instructors noted that because of his insufficient knowledge and confidence, he was hesitant in responding to “both EEC failure”, “engine failure after V1” and “smoke” emergencies during the oral test, and was prone to be nervous when conducting certain procedures or answering questions.

In October 2014, Captain A attended ATR72-500 to -600 differences training in Singapore. He was graded “*may need extra training*” after the simulator session with an instructor’s comment of “*check engine-flame-out-at-take off callout and task sharing and go-around single engine*” on 31 October 2014. This indicated that Captain A had completed the training but may need extra training in next training section or check to validate his handling an engine flame out at take off and single engine go-around. Captain A demonstrated above mentioned items again and passed the next section check on 2 November 2014.

Captain A’s command upgrade and ATR72-600 differences training records within one year of the occurrence, contained several negative comments by IPs and/or CPs on his understanding and performance of single engine flameout at take off procedures. Even though Captain A finally passed the command upgrade and type differences training, there were indications that his ability to handle an engine failure at take off was marginal.

Captain A’s performance during the occurrence was consistent with the reported difficulties he had experienced during training, particularly when performing in stressful emergency situations and included the following negative stress reactions: poor judgment; reduced perception; tendency to cut corners and skip items; and narrowed or restricted the focus of attention. However, TNA did not effectively address the evident and imminent flight safety risk that Captain A presented.

At the time of the occurrence, TNA pilots who performed unsatisfactorily during training or checking activities were offered remedial training for the specific failure

items. However, no further review or follow-up occurred if the pilot's performance was satisfactory on the subsequent check. As a result, TNA did not have a mechanism to identify those pilots who had a recurring pattern of critical performance deficiencies. If TNA had implemented an effective pilot performance review program, they may have been able to provide additional oversight of and/or remedial training for pilots whose performance was marginal. Additional references for air carriers to evaluate a flight crew's ability under stressful situations may also be obtained from the CAA Civil Aviation Medical Center<sup>97</sup> that provides relevant ability indexes (e.g., simultaneous capacity<sup>98</sup>, stress tolerance<sup>99</sup>) using an established assessment system<sup>100</sup>. In cases where pilots were still unable to consistently meet the required standards and, in accordance with common airline industry practice, the pilots flying duties should have been discontinued.

### **2.3.6.5 Command Upgrade Process**

Captain A was promoted to captain in 2014 together with three other first officers. A review of their upgrade process and training identified that:

- In accordance with the flight operations manual, TNA's upgrade selection panel should have comprised at least eight IPs/CPs at the time to assess the candidates initial oral test performance. However, when the Captain A attempted the upgrade selection, the selection panel assessing the Captain's oral test performance comprised only six ATR72 IPs/CPs.

---

<sup>97</sup> The Civil Aviation Medical Center (CAMC) is a non-profit service organization for aviation personnel, which is supervised by the CAA. The responsibilities of the CAMC include: aviation medical examination; health and hygiene education; health care, disease prevention, general and special diagnoses; trainings for emergency rescue, CPR and aviation physiology; psychological assessment and consultation, etc.

<sup>98</sup> Simultaneous capacity is defined as the performance achieved when simultaneously dealing with routine tasks and tasks demanding cognitive performance such as problem solving.

<sup>99</sup> Stress tolerance is defined as the extent to which performance differs when dealing with corresponding routine tasks under normal and stress conditions.

<sup>100</sup> The CAMC psychological assessment system is partially developed on a basis of the "Expert System Aviation (ESA)" of the SCHUHFRIED Company, which contains tests for criteria relevant in the field of aviation psychology, following the requirement of the JAR-FLC3.

- Three of the upgrade candidates, including Captain A, attended and passed the upgrade ground test on 12 May 2014 before they had completed all the required ground courses. That was not in compliance with the training rules in the TNA FTMM.

The airline did not follow its own procedures when selecting and training Captain A for upgrade. TNA's quality assurance processes had not detected that the command selection upgrade process had been compromised.

### **2.3.6.6 Crew Resource Management and Crew Coordination**

During the occurrence flight, several CRM and crew coordination problems were observed throughout the occurrence flight.

#### **Sterile cockpit environment**

According to the CVR from 1041 to 1051, with the exception of performing pre-departure procedures, Captain A (PF) had few additional interactions with Captain B (PM) or the observer pilot. However, Captain B and the observer pilot had a significant number of technical discussions and demonstrations of aircraft systems during the aircraft's push back, propeller rotation, taxi, and holding for takeoff. This was not in accordance with the sterile cockpit rule for that phase of flight. Even though the intention of those discussions was to educate the observer pilot about the aircraft's systems as part of his familiarization training, those lengthy discussions were a source of distraction and may have impeded communication and team building with Captain A. Those discussions may have resulted in the omission of an appropriate pre-take off briefing.

#### **Crew communication**

Both crew members failed to obtain relevant data from each other regarding the status of both engines at different points in the occurrence sequence. The failure by the PF to integrate input from the PM highlighted the fact that inputs to the process of



developing a complete picture of relevant cues for understanding what was happening and where can and often must come from other crew members as well as from an individual's cue-seeking activity.

The quality of the crew's performance depended largely on their ability to recognize the ENG 2 loss of thrust and to respond to the situation by functioning effectively as a team. The training the crew had completed, while meeting regulatory requirements, was not best practice for a complex, twin-engine turboprop aircraft such as the ATR72-600.

During the occurrence flight, several ineffective communication practices were identified:

- After the uncommanded ENG 2 autofeathering and between 1052:43 and 1053:07, it appeared that Captain B (PM) asked Captain A (PF) to wait or delay his movement of the power lever No. 1 (PL1) until the cross check was completed. While the PF momentarily delayed any further retardation of PL1, he later continued to reduce power on ENG 1 which was probably not detected by the PM until the stall warnings and stick shaker activated just before the PF shut down the wrong engine without the required crosschecks. The CVR indicated that the PM attempted to instruct the PF to push the throttle back up but the PF continued to shut down ENG 1. The PM did not appear to challenge the PF about his actions;
- At 1053:05, the PM observed the decreasing airspeed and reminded the PF to "watch the speed". However, the PF did not increase airspeed in response. The PM did not challenge the PF again in response to his inaction regarding the reducing airspeed;
- At 1053:07, the PM announced "number two engine flameout confirmed". Even though the PF responded "okay", he did not process the information because it was apparent that he still believed the affected engine was ENG 1. The PF did not announce or confirm his belief that number one engine had flamed out. If the PF had used clear feedback as per SOPs, and announced his belief that ENG 1 was

the inoperative engine, it would have provided the PM an opportunity to address the PF's misdiagnosis;

- ENG 1 was shut down by the flight crew from 1053:15 to 1053:25. However, flight crew's callouts were nonstandard and unclear during the engine shutdown crosscheck processes.

### **Failure to utilize available resources**

Unless the emergency procedures directed the crew to disconnect the autopilot, it was recommended that it be used as much as possible during these types of situations. However, the PF disconnected the autopilot after the uncommanded autofeather, which increased his workload. In addition, the ATR72-600 aircraft was equipped with an engine and warning display (EWD) system, which clearly indicated that the propulsion system malfunction was an inoperative ENG 2 ('ENG 2 OUT'). However, the PF did not appear to process the information on the EWD.

### **Ineffective leadership**

When the availability, competency, quality or timeliness of leadership does not meet task demands an unsafe situation can arise<sup>101</sup>. Captain A (PF), as the designated pilot-in-command (PIC), was responsible for supervising the overall management of the flight. However, after the uncommanded ENG 2 autofeather, the PF was unable to stabilize and configure the aircraft correctly for single engine operations. He also did not share his understanding of the situation and respond in accordance with SOPs, which provided clear task management roles for each pilot. The absence of leadership, in part, contributed to the confusion in the cockpit and the failure to follow SOPs. However, Captain B (PM) as an experienced pilot did not intervene or take-over to mitigate the absence of leadership from the PF.

---

<sup>101</sup> Wiegmann, D. A., & Shappell, S. A. (2003). A human error approach to aviation accident analysis: The human factors analysis and classification system. Burlington, VT: Ashgate Publishing, Ltd.

### 2.3.6.7 TNA Crew Resource Management Training

Effective crew resource management (CRM) begins in initial training and is reinforced by recurrent practice, assessment and feedback, and should be embedded in every stage of a pilot's training<sup>102</sup>.

The Taiwan CAA issued an Advisory Circular 120-005B on CRM on 23 June 2004. The AC comprised guidance material to help airlines develop, implement, reinforce, and assess CRM training programs. In addition, there were several sets of widely available aviation CRM guidelines<sup>103</sup>. With reference to that material, and as previously identified in the GE222 investigation, there were several deficiencies in TNA's CRM training:

- TNA had not established a systematic CRM assessment process to determine if their training was effective and achieving its goals. This may have resulted in critical areas requiring reinforcement during recurrent training not being identified and/or continuous improvements not being made;
- Proficiency, competency and confidence in CRM instruction, observation, and measurement requires specialist training for CRM facilitators, supervisors, IPs, and CPs. However, TNA did not provide adequate CRM instructor training so the instructors could teach and evaluate a candidate's practical CRM skills;
- The practical application and demonstration of CRM skills during simulator training depended largely on the experience of individual IP's had differing views. TNA had not implemented a formal process for developing detailed and standardized line oriented flight training (LOFT) training with specific CRM

---

<sup>102</sup> Federal Aviation Administration. (2004, January). *FAA Advisory Circular (AC) 120-51E - Crew Resource Management Training*. Washington, DC: FAA.

<sup>103</sup> ICAO Circular 217-AN/132 (1989) –Flight Crew Training: Cockpit Resource Management (CRM) and Line-Oriented Flight Training (LOFT); Flight Safety Foundation (2009) *Operator's Guide to Human Factors in Aviation*; UK Civil Aviation Authority CAP 731 (October 2014) *Flight Crew Human Factors Handbook*; Federal Aviation Administration's (FAA) Advisory Circular (AC) 120-35D (13 March 2015) – *Flight Member Line Operational Simulations: Line-Oriented Flight Training, Special Purpose Operational Training, Line Operational Evaluation, etc.*

objectives;

- Audiovisual feedback during LOFT and simulator debriefings was generally not utilized by TNA IPs. Such a tool can be very effective in assisting crews to evaluate and improve their own CRM performance; Unlike some other airlines, TNA's command upgrade training did not include a human factors (HF) course, with elements addressing some of the HF challenges associated with command;
- The CRM ground course training materials were very limited and did not reflect current CRM research and industry best practice in regards to communication/interpersonal skills, problem-solving/decision-making, leadership/followership, and critique, and so on. In addition, there was no documented recurrent CRM course syllabus, learning objectives, or length/training hour requirement.

TNA did not use widely available CRM guidelines to develop, implement, reinforce, and assess their flight crew CRM training program. The occurrence flight crew's performance was consistent with ineffective CRM training. Finally, as identified in the GE222 investigation, the CAA's oversight of flight crew training, including CRM training, was in need of significant improvement.

### **2.3.6.8 Negative Transfer**

An understanding of why the PF shut down the ENG 1 (the 'wrong engine'), which was fully operative was explored. Hypotheses regarding the potential influence of the pilot's previous multi-engine training and experience were considered. Interviews with TNA ATR72 flight crew indicated that the ENG 1 was not constantly used as the reference engine for simulated engine failure training and checking scenarios. However, Captain A had experienced one previous uncommanded autofeather events involving the ENG 1 during a normal revenue flight when he was a TNA first officer acting in the role of PM. The likelihood that negative transfer adversely affected the PF's response to the uncommanded ENG 2 autofeather was unable to be established.

## **2.3.7 ATR72 Differences Training Program and TNA Records Management**

### **2.3.7.1 Training Program**

TNA's ATR72-500 to ATR72-600 differences training program was developed in accordance with the European Aviation Safety Agency (EASA) ATR42/72 Flight Crew Qualifications Operational Evaluation Board (OEB) report. There were various types of ATR72-600 differences training programs depending on the pilot's total flight time, type experience, and the configuration and onboard equipment of previous ATR72 aircraft flown. The two standard ATR72-600 differences training programs recommended by the OEB report included 5-day and 10-day programs. The TNA ATR72-600 differences training program approved by the CAA followed the 5-day program defined in the OEB report. The differences training records also showed that, at the commencement of training, the ATR instructors checked every TNA pilot's qualifications to ensure that they met the pre-requisites for the 5-day training program. In addition to the ATR training, the CAA required that an extra simulator check be conducted by a designated examiner (DE) or CAA inspector following the ATR ground and simulator training.

The TNA ATR72-600 differences training program was compliant from a CAA regulatory perspective. However, interviews with TNA ATR72-600 pilots indicated that pilots without advanced automation experience found the differences training to be inadequate, especially in regard to FMS and electronic displays familiarization. With reference to the GE235 occurrence, the CVR and FDR showed that Captain A (PF) failed to utilize the autopilot and flight warning system to identify and manage the emergency situation. This may have been a result of Captain A's lack of knowledge, understanding and confidence in using the aircraft's automated support systems, which may, in part, have been a function of insufficient differences training. Captain A's simulator check at the conclusion of differences training indicated that he may need

further training particularly for engine out operations. The CAA and TNA need to reconsider if the current 5-day ATR72 differences course and subsequent line training is sufficient to ensure that TNA flight crews are competent to operate the ATR72-600 under all normal and non-normal conditions.

Furthermore, the flight instrument differences of ATR72-500 and ATR72-600 is from a conventional flight instruments including analog displays to a more advanced avionic suite with PFD and electronic check list. The visual pattern and information picked up by the crew in an emergency situation may not be retrieved at the same location with the same display, although in the GE235 occurrence the CVR evidenced that the PM called-out the proper engine flame out procedure associated with ENG 2 and that the PF was still mentioning the ENG 1. The Safety Council believes it is required to study the content and the duration of the minimum requirement regarding a difference course between a conventional avionics cockpit and an advanced suite including enhanced automated modes for aircraft having the same type rating.

### **2.3.7.2 Records Management**

According to the aircraft flight operation regulations and TNA's flight operations manual, TNA was required to establish a system to retain all flight crew training records during the employment period for CAA's inspection.

However, TNA flight crew training records showed that the ART72-600 differences training records for all ATR72-600 pilots were not completely maintained by TNA. The TNA training department assistant manager advised that the differences training records were kept at ATR training center in Singapore.

TNA failed to maintain the differences training records in accordance with the Aircraft Flight Operation Regulations and the TNA flight operations manual.

The ATR72-600 differences training records for the GE235 flight crew showed that Captain A may need more training on the single engine flameout at take off procedure. That meant if the differences training records were stored, adequately

maintained and evaluated by appropriate TNA flight operations and/or quality assurance personnel, TNA would have had yet another opportunity to review Captain A's ability to handle engine out emergencies.

## **2.4 CAA Oversight**

After the GE222 occurrence, the CAA conducted an in-depth inspection of TNA flight operations, system operations control, and safety and security from 14 to 30 August 2014. In response to that CAA inspection, TNA initiated several programs to improve flight safety. Those programs included addressing the deficiencies in the airline's safety management system (SMS) and flight operations quality assurance (FOQA) system, the standardization of flight crew training and checking, the establishment of procedures for continuous descent final approach (CDFA), and the improvement of crew resource management (CRM) training and flight crew fatigue management.

These safety issues were still being addressed by the airline at the time of the GE235 occurrence, which was seven months after the GE222 occurrence. The systemic TNA flight crew non-compliance with procedures remained unaddressed. The CAA urgently needs to enhance the surveillance of TNA's operations and ensure that TNA's safety improvement programs implemented in a timely and effective manner. The GE222 investigation was still in progress when the Council initiated the GE235 investigation. During the GE222 investigation, the Council identified specific CAA regulatory oversight issues. The GE222 and GE235 investigation revealed that there were similar problems with CAA oversight of TNA. The GE222 investigation report has already documented the specific areas for improvement in CAA's regulatory surveillance activities so they were not discussed further in this report.

## Chapter 3 Conclusion

In this Chapter, the Aviation Safety Council presents the findings derived from the factual information gathered during the investigation and the analysis of the occurrence. The findings are presented in three categories: findings related to the probable causes, findings related to risk, and other findings.

The findings related to the probable causes identify elements that have been shown to have operated in the occurrence, or almost certainly operated in the occurrence. These findings are associated with unsafe acts, unsafe conditions, or safety deficiencies associated with safety significant events that played a major role in the circumstances leading to the occurrence.

The findings related to risk identify elements of risk that have the potential to degrade aviation safety. Some of the findings in this category identify unsafe acts, unsafe conditions, and safety deficiencies including organizational and systemic risks, that made this occurrence more likely; however, they cannot be clearly shown to have operated in the occurrence alone. Furthermore, some of the findings in this category identify risks that are unlikely to be related to the occurrence but, nonetheless, were safety deficiencies that may warrant future safety actions.

Other findings identify elements that have the potential to enhance aviation safety, resolve a controversial issue, or clarify an ambiguity point which remains to be resolved. Some of these findings are of general interests that are often included in the ICAO format accident reports for informational, safety awareness, education, and improvement purposes.

### 3.1 Findings Related to Probable Causes

#### Powerplant

1. An intermittent signal discontinuity between the autofeather unit (AFU) number 2 and the torque sensor may have caused the automatic takeoff power control system



(ATPCS):

- Not being armed steadily during takeoff roll;
- Being activated during initial climb which resulted in a complete ATPCS sequence including the engine number 2 autofeathering.(1.6, 1.11, 1.16.5, 2.2)

2. The available evidence indicated the intermittent discontinuity between torque sensor and auto feather unit (AFU) number 2 was probably caused by the compromised soldering joints inside the AFU number 2. (1.6, 1.11, 1.16.5, 2.2)

### **Flight Operations**

3. The flight crew did not reject the take off when the automatic take off power control system ARM pushbutton did not light during the initial stages of the take off roll. (1.11, 1.17.6, 1.18.2, 2.3.1)

4. TransAsia did not have a clear documented company policy with associated instructions, procedures, and notices to crew for ATR72-600 operations communicating the requirement to reject the take off if the automatic take off power control system did not arm. (1.17.6, 1.18.2, 2.3.1)

5. Following the uncommanded autofeather of engine number 2, the flight crew failed to perform the documented failure identification procedure before executing any actions. That resulted in pilot flying's confusion regarding the identification and nature of the actual propulsion system malfunction and he reduced power on the operative engine number 1. (1.11, 1.18, 2.3.3)

6. The flight crew's non-compliance with TransAsia Airways ATR72-600 standard operating procedures - Abnormal and Emergency Procedures for an engine flame out at take off resulted in the pilot flying reducing power on and then shutting down the wrong engine. (1.11, 1.18, 2.3.4)

7. The loss of engine power during the initial climb and inappropriate flight control inputs by the pilot flying generated a series of stall warnings, including activation of the stick pusher. The crew did not respond to the stall warnings in a timely and

effective manner. (1.11, 1.18, 2.3.3)

8. The loss of power from both engines was not detected and corrected by the crew in time to restart an engine. The aircraft stalled during the attempted restart at an altitude from which the aircraft could not recover from loss of control. (1.11, 1.18, 2.3.5)
9. Flight crew coordination, communication, and threat and error management (TEM) were less than effective, and compromised the safety of the flight. Both operating crew members failed to obtain relevant data from each other regarding the status of both engines at different points in the occurrence sequence. The pilot flying did not appropriately respond to or integrate input from the pilot monitoring. (1.11, 1.17, 1.18, 2.3.6)

## **3.2 Findings Related to Risk**

### **Powerplant**

1. The engine manufacturer attempted to control intermittent continuity failures of the auto feather unit (AFU) by introducing a recommended inspection service bulletin at 12,000 flight hours to address aging issues. The two AFU failures at 1,624 flight hours and 1,206 flight hours show that causes of intermittent continuity failures of the AFU were not only related to aging but also to other previously undiscovered issues and that the inspection service bulletin implemented by the engine manufacturer to address this issue before the occurrence was not sufficiently effective. The engine manufacturer has issued a modification addressing the specific finding of this investigation. This new modification is currently implemented in all new production engines, and another service bulletin is available for retrofit. (1.6, 1.11, 1.16.5, 1.18.4, 2.2.3)

### **Flight Operations**

2. Pilot flying's decision to disconnect the autopilot shortly after the first master

warning increased the pilot flying's subsequent workload and reduced his capacity to assess and cope with the emergency situation. (1.11, 1.18, 2.3.3)

3. The omission of the required pre-take off briefing meant that the crew were not as mentally prepared as they could have been for the propulsion system malfunction they encountered after takeoff. (1.11, 1.18, 2.3.6)

### **Airline Safety Management**

4. TransAsia Airways (TNA) did not follow its own procedures when selecting and training pilot flying for upgrade. The TNA's quality assurance processes had not detected that the command selection upgrade process had been compromised. (1.17, 2.3.6)
5. TransAsia Airways (TNA) did not use widely available crew resource management (CRM) guidelines to develop, implement, reinforce, and assess the effectiveness of their flight crew CRM training program. (1.17, 1.18, 2.3.6)
6. While the TransAsia Airways (TNA) ATR72-600 differences training program was consistent with the European Aviation Safety Agency ATR72 operational evaluation board report and compliant from a Civil Aeronautics Administration regulatory perspective, it may not have been sufficient to ensure that TNA flight crews were competent to operate the ATR72-600 under all normal procedures and a set of abnormal conditions. (1.17, 1.18, 2.3.7)
7. The ATR72-600 differences training records for the GE 235 flight crew showed that Captain A probably needed more training on the single engine flame out at take off procedure. That meant if the differences training records were stored, adequately maintained and evaluated by appropriate TransAsia Airways (TNA) flight operations and/or quality assurance personnel, the TNA would have had yet another opportunity to review Captain A's ability to handle engine out emergencies. (1.5, 1.17, 2.3.7)
8. Captain A's performance during the occurrence was consistent with his performance

weaknesses noted during his training, including his continued difficulties in handling emergency and/or abnormal situations, including engine flame out at take off and single engine operations. However, TransAsia Airways did not effectively address the evident and imminent flight safety risk that Captain A presented. (1.5, 1.17, 1.18, 2.3.7)

### **Regulatory Oversight**

9. The Civil Aeronautics Administration's (CAA) oversight of flight crew training, including crew resource management (CRM) training, is in need of improvement. (1.17.7, 2.3.6, 2.4)
10. The systemic TransAsia Airways (TNA) flight crew non-compliances with standard operating procedures identified in previous investigations, including GE 222, remained unaddressed at the time of the GE235 occurrence. Although the Civil Aeronautics Administration (CAA) had conducted a special audit after the GE 222 accident which identified the standard operating procedures compliance issue, the CAA did not ensure that TNA responded to previously identified systemic safety issues in a timely manner to minimize the potential risk. (1.17, 2.4)

### **3.3 Other Findings**

1. The flight crew were certificated and qualified in accordance with Civil Aeronautics Administration (CAA) regulations and company requirements. There was no evidence to indicate that the flight crew's performance might have been adversely affected by pre-existing medical conditions, fatigue, medication, other drugs or alcohol during the occurrence flight. (1.5, 1.13, 2.1)
2. Visual meteorological conditions (VMC) prevailed at the time of the aircraft's departure. No adverse weather conditions were present for the flight. (1.7, 2.1)
3. The aircraft's certificate of airworthiness and registration were current at the time of the occurrence. The occurrence aircraft was dispatched at Songshan Airport with no known defects and was in compliance with all applicable airworthiness directives

and service bulletins. A review of the aircraft's maintenance records before the occurrence flight revealed that there were no defects reported that related to engine number 2 automatic feathering system. (1.6, 2.2)

4. Flight crew transferred from conventional flight instruments to a more advanced avionic suite with primary flight display, the visual pattern and information picked up by the crew in an emergency situation may not be retrieved at the same location with the same display. (1.17.3, 2.3.7.1)
5. Although the influence of the flight director indication was not demonstrated in the occurrence flight and the logics of ATR flight director bars are consistent with other aircraft types within the industry, the simulator flight illustrated the flight director bars indication during stall warning were in contradiction with the automatic stall protection inputs and thus may disturb the crew. (1.16.2, 2.3.5)
6. The ATR72 formal document has no general statement of rejecting take off policy and procedure of rejecting take off with both engines operative. (1.17, 2.3.2)

## Chapter 4 Safety Recommendations

In this chapter, safety recommendations derived as the result of this investigation are listed in section 4.1. Safety actions taken, safety actions that have been accomplished, or are currently being accomplished are listed in section 4.2. It should be noted that the safety actions listed in section 4.2 have not been verified by the Safety Council.

The GE222 investigation had identified specific areas for enhancement and issued 24 recommendations to TransAsia Airways and Civil Aeronautics Administration. Those safety issues were still being addressed by the airline and the regulator at the time when the Aviation Safety Council published the GE235 occurrence investigation report. Therefore, the similar safety recommendations will not be issued again in this report.

### 4.1 Recommendations

#### TransAsia Airways

1. Document a clear company policy with associated instructions, procedures, training, and notices to crew members for ATR72-600 operations communicating the requirement to reject a take off in the event that the automatic take off power control system (ATPCS) is not armed as required.(ASC-ASR-16-06-001)
2. Conduct a thorough review of the airline's flight crew training programs, including recurrent training, crew resource management (CRM) training, upgrade training, differences training, and devise systematic measures to ensure that
  - Standardized flight crew check and training are conducted;
  - All flight crews comply with standard operating procedures;
  - All flight crews are proficient in handling abnormal and emergency procedures, including engine flame out at take off;
  - The airlines use widely available guidelines to develop, implement, reinforce, and

assess the effectiveness of their flight crew resource management (CRM) training program, particularly the practical application of those skills in handling emergencies;

- Command upgrade process and training comply with the airline's procedures and that competent candidates are selected;
- ATR72-600 differences training and subsequent line training are sufficient to ensure that flight crews are competent to operate the ATR72-600 under all normal and abnormal conditions; and
- All flight crew training records during the employment period are retained in compliance with the aircraft flight operation regulations;

(ASC-ASR-16-06-002)

3. Improve the airline's internal quality assurance oversight and audit processes to ensure that recurring safety, training, and administrative problems are identified and rectified in a timely manner. (ASC-ASR-16-06-003)
4. Implement and document an effective and formal pilot performance review program to identify and manage pilots whose performance is marginal. (ASC-ASR-16-06-004)
5. Evaluate the safety culture of the airline to develop an understanding of the reasons for the airline's unacceptable safety performance, especially the recurring noncompliance with procedures. (ASC-ASR-16-06-005)

### **Civil Aeronautics Administration**

1. Review airline safety oversight measures to ensure that safety deficiencies are identified and addressed in an effective and timely manner. (ASC-ASR-16-06-006)
2. Implement a highly robust regulatory oversight process to ensure that airline safety improvements, in response to investigations, audits, or inspections, are implemented in a timely and effective manner. (ASC-ASR-16-06-007)
3. Conduct a detailed review of the regulatory oversight of TransAsia Airways to

identify and ensure that the known operational safety deficiencies, including crew noncompliance with procedures, nonstandard training practices, and unsatisfactory safety management, were addressed effectively. (ASC-ASR-16-06-008)

4. Provide inspectors with detailed guidance on how to evaluate the effectiveness of operator nontechnical training programs such as crew resource management (CRM) and threat and error management (TEM) training programs. (ASC-ASR-16-06-009)

#### **UTC Aerospace System Company**

1. Work with the manufacturers of engine and aircraft to assess the current operating parameters and aircraft risks associated with the PW127 series engine auto feather unit (AFU) to minimize or prevent occurrences that could result in uncommanded autofeather. (ASC-ASR-16-06-010)

#### **Pratt & Whitney Canada**

1. Work with manufacturers of the autofeather unit and airframe to assess the current operating parameters and aircraft risks associated with the PW127 series engine autofeather unit (AFU) to minimize or prevent occurrences that could result in uncommanded autofeather. (ASC-ASR-16-06-011)

#### **Avions de Transport Régional**

1. Work with manufacturers of the auto feather unit and engine to assess the current operating parameters and aircraft risks associated with the PW127 series engine auto feather unit (AFU) to minimize or prevent occurrences that could result in uncommanded autofeather. (ASC-ASR-16-06-012)
2. Publish in the flight crew operating manual (FCOM) an operational procedure related to rejected take off and expanded information regarding conditions leading to rejected take off. (ASC-ASR-16-06-013)

#### **European Aviation Safety Agency**

1. Require a review at industry level of manufacturer's functional or display logic of



the flight director so that it disappears or presents appropriate orders when a stall protection is automatically triggered.(ASC-ASR-16-06-014)

2. Study the content and the duration of the minimum requirement regarding a differences training program between a conventional avionics cockpit and an advanced suite including enhanced automated modes for aircraft having the same type rating.(ASC-ASR-16-06-015)
3. Require a review of manufacturer's airplane flight manual (AFM) to ensure that a rejected take off procedure is also applicable to both engines operating.(ASC-ASR-16-06-016)

## **4.2 Safety Actions Accomplished**

### **4.2.1 TransAsia Airways**

On 24 May 2016, TransAsia Airways provided the safety actions accomplished or being accomplished after the GE235 occurrence. Those actions were not verified by the Aviation Safety Council, and are presented as follows:

The TNA overall improvements in safety, training and management system have been implemented since the GE235 event. The improvements are illustrated as following:

1. Regarding to Just Culture, Just Culture has been immerged as the fundamental policy for TNA, and each event will be treated under Just Culture.
2. The TNA SMS fulfills the safety commitment from the management, and safety action group (SAG) closed supports safety review board (SRB) to continuously monitor SPI/SPT to enhance safety promotions, and consolidate risk management.
3. Under integrated structure of SMS and QMS development, the safety and quality assurance program (SQAP) has been introduced into the TNA system to regulate quality associated planning, activities, and internal audits. The SQAP implemented the plan-do-check-action cycles to activity figure out weakness of TNA operational flows, procedures, and documentation. At the same time, regarding to quality

analysis and statistics, a standardize procedure is comply with information relay back to SPI /SPT, to perfect safety assurance and quality assurance. The key points of SQAP as following:

- (1) Team up TNA audit SME.
  - (2) Implemented qualification and training (initial / recurrent) programs for TNA internal auditors.
  - (3) Implemented audit finding tracking system.
  - (4) Increased quality analysis capability.
4. The following improvements were made to reinforce the FOQA operations:
- (1) Streamlining the flight data download process to accelerate the data process and ensure the download rate.
  - (2) Settling the multiplex network which allows parallel and timely data process and analyze.
  - (3) Compiling the FOQA operation manual to rule up the operations procedures, working flow and the training of each practitioner.
  - (4) Recruiting safety pilots to resolve the data into usable information.
  - (5) Conducting OJT under Airbus to level up the competency of every practitioner.
5. Structure in Flight Operations had enhanced, including:
- (1) Training and check were separated as independent functions under FOP. Three newly appointed check pilots, titled as check supervisors from ATR, A320 and A330 respectively, formed the Check Section in 20 MAY 2015.
  - (2) Three pilots from ATR, A320 and A330 fleet respectively were appointed as technical pilots in Fleet Management Department in 01 NOV, 2015, to assist chief pilots in handling flight operations quality assurance, crew reports and performance appraisal.
  - (3) A new vice president of flight operations, reporting to the president of TransAsia Airways, took the office in 05 NOV, 2015, to supervise FOP in compliance with international and local regulatory requirements, safety management performance

and company development.

(4) Management pilots in FOP, excluded the VP Flight Operations, increased from 9 to 15 (+66%)

6. In order to ensure flight crews comply with TNA standard operating procedures (SOP),

(1) ATR, A320 and A330 SOPs and standard callouts were thoroughly reviewed, revised and accepted by the CAA in FEB 2015. Subsequent revision on ATR SOP was accepted by the CAA in APR 2015. Subsequent revision on A320 SOP were revised and accepted by the CAA in JUN 2015.

(2) Enhanced SOP training:

ATR: All pilots completed SOP training in MAR 2015 and completed a second refresh SOP training, as the SOPs been revised, in MAY 2015.

A320: All pilots completed SOP training in MAR and APR 2015 and completed a second refresh SOP training, as the SOPs been revised, in JUL 2015.

A330: All pilots completed SOP training in MAR 2015.

(3) Audits on TNA pilots SOP compliance have been conducted via:

Standard operational audits;

Observations flights on all pilots;

TransAsia line operations audit.

The actions above ensure SOPs are fully implemented by flight crew.

7. The crew resources management (CRM) and joint CRM (JCRM) have been enhanced via the following actions:

(1) From 29 MAR to 10 APR, 2015, ATR pilots were all trained on CRM and threat and error management (TEM) by six TNA trainers trained by ATR TRE during their support period in TransAsia Airways.

(2) From 13 MAR to 30 APR, 2015, all ATR/A320/A330 pilots attended additional 6 hours of CRM, trained by an external CRM facilitator.

(3) From 11 JUN to 30 JUN, 2015, 8 pilot trainers and 4 cabin trainers were trained

as TNA CRM/joint CRM (JCRM) facilitators by China Airlines, an outsourced JCRM education provider recognized in Taiwan. After a 5-day intensive CRM/JCRM train the trainer (TTT) course, they formed up a core CRM/JCRM task force (TNA JCRM facilitators) to conduct CRM/JCRM training for flight and cabin crewmembers afterwards.

- (4) In NOV 2015, TNA JCRM facilitators had developed training materials for 8-hour initial training and 3-hour joint CRM materials, as the JCRM foundation for the future CRM training, starting with the recurrent training from 2016. The JCRM program was accepted by the CAA in 18 NOV 2015 (cabin training manual REV 013T4).
8. Pilot's aviation knowledge refreshment is achieved via a 5-day (40 hours) program, undertaken since APR 2015.
9. Instructor (IP) and check pilot (CP) standardization has been enhanced by the following actions:
  - (1) In APR 2015, TNA selected two ATR CPs to attend the TRI Course in ATR. They converted the training concepts into current TNA training system.
  - (2) In SEP 2015, TNA selected two A330 IP/CPs to attend the APIC (Airbus pilot instructor course) in Airbus. They converted the APIC materials and training concepts into current TNA training system.
  - (3) In OCT 2015, the manager of training department (rated on the A330) conducted CP/IP standardization observations on A320 and ATR simulator sessions.
  - (4) In 2015, 4 ATR, 5 A320 and 8 A330 IPs and CPs had been evaluated by other IPs or CPs in simulator sessions and ground school, as the over-the-shoulders (OTS), for their proficiency and performance. The same evaluation program continues in 2016.
  - (5) From JUN 2016 to AUG 2016, all IPs and CPs from ATR, A320 and A330 will start a 2-day workshop to promote instructing skills to achieve standardization cross the fleet.

#### **4.2.2 Civil Aeronautics Administration**

On 24 May 2016, CAA provided the safety actions accomplished or being accomplished after the GE235 occurrence. Those actions were not verified by the Aviation Safety Council, and are presented as follows:

I. Implement Immediate actions, Short-Term, Mid-Term and Long-Term safety improvement initiatives (Supervised by MOTC)

1. For TransAsia Airways

(1) Immediate actions (2015.06.30): Conducted Flight Crew Fatigue management inspection and found compliance with the flight operations regulation requirements; Completed ATR-72 fleet's engine system special inspection and results are normal; and Completed ATR-72 fleet pilot's oral test and proficiency check.

(2) Short-term initiatives (2015.12.31):

- i. Implemented additional A320/321 pilot's oral test and proficiency check.
- ii. Oversaw the TransAsia Airways' incorporation of international aviation expert teams to assist it enhancing safety management capability.

2. For all national air operators

(1) Short-term initiatives (2015.12.31):

- i. Increased inspection frequencies to foreign flight simulator tests: increased inspection frequencies to foreign flight simulator pilot tests for those air operators that do not own flight simulation training devices.
- ii. Enhance aircraft defect control management and aging aircraft inspection programs: conducted in-depth oversight and inspections to aircraft repeat defects and deferred items management and aging aircraft inspection programs.
- iii. Safety Management System implementation: required and oversaw the

national air operators to implement a Safety Management System and meet the phase 3 requirement by the end of 2015.

(2) Mid-term initiatives (2016.12.31) and top priorities of this year:

- i. Required all 6 major national air operators to fully implement the SMS before the end of 2016. The CAA also used the acceptable level of safety defined in the State Safety Program to require the national air operators to submit their safety performance indicators (SPI), safety performance target (SPT) and the safety action plans to enhance aviation safety.
- ii. Used standards of CFR Part 117 to incorporate physiological state to pilot flight time and duty limitation and rest requirement consideration so as to amend the CAA ‘Aircraft Flight Operation Regulations.’

## II. Deepening aviation Safety actions

1. Starting from 2016, the CAA takes predictive actions through flight operation quality assurance (FOQA) System to require the national air operators to submit quarterly FOQA primary control parameter data report for the CAA to conduct risk analysis and take proactive actions in advance according to the safety data.
2. Digitalize safety management. Starting from 2016, the CAA requires the national air operators to annually submit safety performance indicators to ensure their SMS operating in accordance with the complicities of their organizations and support by the internal and external safety information data.
3. Starting from 2016, the CAA main base inspections to the national air operators are conducted the special project team so as to find the deficiencies of the air operators in time through more strict standards and to ensure that the corrective actions to found deficiencies be put in effect.
4. Increase flight safety information data sharing with flight incident and accident investigation organization and other aviation authorities.

### 4.2.3 Avions de Transport Régional

On 1 April 2016, ATR provided the safety actions accomplished or being accomplished after the GE235 occurrence. Those actions were not verified by the Aviation Safety Council, and are presented as follows:

ATR issued in March 2015 an OEB on uncommanded autofeather events to re-emphasis that:

- Any loss of engine propeller rotation speed (NP) and/or torque (TQ) should be dealt with as an engine failure.
- At takeoff, the ATPCS must be checked armed and announced. If it is not armed while both power levers are in the notch, or in the case of intermittent arming / disarming of the ATPCS, the aircraft is not in the appropriate configuration for takeoff. By definition, any check not completed halts the procedure and takeoff should be aborted.

ATR also reviewed in March 2015, after four years of experience in service worldwide, based on our feedback and from our global network of operators, and following guidance from the French Authority, as well as EASA and other national aviation authorities, the 1 week ATR 500 to ATR 600 differences course has been overhauled with joint goals:

- to ensure optimal trainee progress using a competency-based training approach and
- to maximize crewmembers' operational readiness following training

The highlights of the new program are as follows:

- 7 hours of Full-Flight Simulator training to fully master the navigation, handling and avionics improvements on the ATR600 in a realistic operational environment
- Ample practice as flying pilot and monitoring pilot for safety-critical manoeuvres such as non-normal and emergency operations, severe icing encounters, non-precision approaches, go-arounds and engine malfunctions treatment

- Special emphasis on CRM aspects of the powerful new avionics capabilities such as the Flight Management and Flight Guidance Systems.

Furthermore, precise performances based on pilot skill and systems understanding have been implemented in order to guide instructors to validate the pilot competences on the new variant 72-600.



Intentionally Left Blank

## Appendix 1 The ATC Radio and Hotline Communication Transcript

GC: Ground Controller of Songshan Tower

LC: Local Controller of Songshan Tower

GE235: GE235 pilots

SP: Supervisor of Songshan Tower

WR: West Songshan Radar Position Controller of Taipei Approach

WM: Songshan Monitoring Position Controller of Taipei Approach

NM: North Taoyuan Monitoring Position Controller of Taipei Approach

Note: shaded columns indicate the hotline communications between Songshan Tower and Taipei Approach

TIME	COM.	CONTENTS
1034:28	GE235	songshan ground good morning transasia two tree...uh five at bay one two request start ... uh flight level one four zero to kinmen with sierra
1034:38	GC	transasia two tree five songshan ground copy clearance cleared to sandy d m e fix via mucha two quebec departure whiskey six maintain five thousand squawk four six zero two
1034:51	GE235	cleared to sandy via mucha two quebec departure ...uh join whiskey six maintain five thousand squawk four six zero two transasia two tree five
1034:59	GC	transasia two tree five clearance read back correct
1040:51	GE235	songshan ground transasia two tree five bay one two request start up and push back
1040:55	GC	transasia two tree five start up and push back approved runway one zero
1040:59	GE235	start up and push back approved runway one zero transasia two tree five
1044:59	GE235	songshan ground transasia two tree five request taxi
1045:01	GC	transasia two tree five runway one zero taxi via whiskey
1045:05	GE235	taxi via whiskey to runway one zero transasia two tree five

1045:52	GC	transasia two tree five contact tower one one eight decimal one good day
1045:55	GE235	contact tower one one eight one transasia two tree five good day
1046:06	GE235	songshan tower good morning transasia two tree five taxi with you
1046:10	LC	transasia two tree five songshan tower due to initial separation hold short runway one zero for landing traffic
1046:16	GE235	hold short runway one zero transasia two tree five
1050:09	LC	transasia two tree five line up and wait runway one zero
1050:12	GE235	line up and wait runway one zero transasia two tree five
1050:14	LC	復興兩三五起飛五兩 [transasia two tree five take off at five two]
1050:17	WR	好 [okay]
1051:13	LC	transasia two tree five runway one zero wind one zero zero degrees niner knots cleared for take off
1051:19	GE235	cleared for take off runway one zero transasia two tree five
1052:34	LC	transasia two tree five contact taipei approach one one niner decimal seven good day
1052:38	GE235	one one niner seven transasia two tree five good day
1053:35	GE235	tower transasia two tree five mayday mayday engine flame out
1053:37	WR	塔臺復興兩三五再換 [tower transfer transasia two tree five again]
1053:39	LC	transasia two tree five please try again contact taipei approach one one niner decimal seven
1053:44	LC	我再換一次給你 [i transfer it to you again]
1053:47	WR	好謝謝 [okay thanks]
1054:08	WM	塔臺你有看到復興兩三五嗎 [tower do you see transasia two tree five]
1054:14	LC	我看不到實機 [i cannot see the aircraft]
1054:33	WM	塔臺你再幫我叫一下復興兩三五 [tower please help me to call transasia two tree five again]

1054:35	LC	叫叫他然後呢 [call call him and than]
1054:38	WM	和他確認一下叫他換近場臺啊他高度一直往下掉 [confirm with him and instruct to contact approach he is losing altitude]
1054:41	LC	transasia two tree five songshan tower
1054:47	LC	transasia two tree five songshan tower
1054:53	LC	教官我叫不到復興兩三五 [sir i cannot contact transasia two tree five]
1055:03	LC	transasia two tree five songshan tower
1055:12	NM	塔臺 approach 復興兩三五剛剛有滾行嗎 [tower approach did transasia two tree five have rolling take off a moment ago]
1055:15	LC	有有有 [yes yes yes]
1055:16	NM	然後咧 [and than]
1055:17	LC	有爬到高度么千有有換出來 [climbed to one thousand and was handed off]
1055:20	NM	他有跟你講話是嗎 [did he speak with you]
1055:22	NM	叫不到他耶 [i cannot contact him]
1055:23	LC	我現在也叫不到他 [i also cannot contact him now]
1055:24	NM	OK
1055:58	WR	你們也叫一下復興哦 [please call the transasia too]
1056:05	LC	transasia two tree five songshan tower
1056:09	LC	transasia two tree five songshan tower
1056:20	LC	教官我還是叫不到他 [sir i still cannot contact him]
1056:23	NM	所以他剛剛有爬到一千多 [so he did climbed to more than one thousand a moment ago]
1056:25	LC	有 [yes]

1056:26	NM	完全看不到完全 coast 掉了 [cannot see him entirely has been coasted entirely]
1056:33	NM	塔臺 guard 波道叫叫看啊謝謝 [tower try to call him by guard channel thanks]
1056:47	LC	transasia two tree five songshan tower
1056:53	LC	transasia two tree five songshan tower
1057:09	WR	塔臺 approach [tower approach]
1057:11	LC	請 [go ahead]
1057:11	WR	取消自動放行 [cancel auto release]
1057:12	LC	好 [okay]
1057:13	WR	好 [okay]
1057:14	SP	我們持續的呼叫啦厚阿你那邊也叫一下 [we continue to call him oh you call him too]
1057:38	NM	塔臺 approach 妳不要再放起飛的了先暫停暫停放行喔 [tower approach please don't release takeoff suspend release oh]
1057:43	SP	取消自動放行我們先等一下看一下情況再跟你講喔 [cancel auto release we wait a while look at the situation and then tell you oh]
1059:09	SP	欸哈囉 [hey hello]
1059:12	WR	請是 [go ahead]
1059:13	SP	欸那個我們叫不到啦厚 [hey we cannot contact him oh]
1059:15	WR	教官你們叫他換的時候有回你們嗎 [sir did he read back when you instructed him to change frequency]
1059:17	LC	有有 [yes yes]
1059:17	SP	有他有回 [he did read back]
1059:18	WR	他有回是不是 [he did read back yes or no]
1059:19	SP	有換走換么么 [has been transferred transferred to one one]

1059:20	WR	因為沒有來我們這裡 [because he didn't contact us]
1059:21	SP	蛤 [what]
1059:22	WR	我們他們沒有跟我們聯絡我們也叫不到他 [we they didn't contact us we cannot contact him]
1059:24	SP	好好 [okay okay]
1059:24	WR	對 [right]
1059:25	SP	OK 好
1059:24	WR	好 [okay]
1104:38	NM	塔臺 approach 請問跑道有可以正常進去嗎航務有出來巡跑道嗎 [tower approach could the runway be entered normally does the flight operations go checking the runway]
1104:46	LC	教官我問一下好了 [sir i ask for it]
1104:47	NM	好謝謝 [okay thanks]
1105:11	LC	approach 塔臺 [approach tower]
1105:12	WR	請講 [go ahead]
1105:13	LC	教官我們請航務組出來巡預計要等五分鐘 [sir we ask the flight operations to go checking the runway expected to wait five minutes]
1105:18	WR	要等五分鐘好 [wait five minutes okay]
1107:13	SP	Approach 塔臺 [approach tower]
1107:16	NM	請講 [go ahead]
1107:17	SP	那個我們請航務組做場面最後確認那沒有問題跑道就開放會儘快通知你 [we ask the flight operations office to do the final surface confirmation if there are no problems the runway will be open will tell you soon]
1107:23	WR	暫時不進去嘛喔 [not to enter temporarily oh]
1107:24	SP	唉對先暫時對不好意思 [alas yes temporarily sorry]

1107:28	WR	好 [okay]
1109:49	LC	Approach 塔臺跑道現在開放 [approach tower the runway is open now]
1109:53	WR	好 [okay]
1109:59	LC	Approach 塔臺是否恢復自動放行 [approach tower could auto release be resumed]
1110:03	WR	好 [okay]
1110:31	WR	塔臺 approach [tower approach]
1110:32	LC	請 [go ahead]
1110:33	WR	那個放行還是先暫停等確切的消息 [suspend release wait for the exact message]
1110:40	LC	教官那要等多久 [sir how long]
1110:42	WR	等塔臺長告訴我們 [wait for the chief]
1110:44	LC	好好 [okay okay]

## Appendix 2 GE 235 CVR Transcript

- RDO : Radio transmission from occurrence aircraft  
 CAM : Cockpit area microphone voice or sound source  
 INT : Interphone  
 PA : Cabin announcement  
     (RDO, CAM, INT, PA)-1 : Voice identified as captain  
     (RDO, CAM, INT, PA)-2 : Voice identified as first officer  
     (RDO, CAM, INT, PA)-3 : Voice identified as observer  
     (RDO, CAM, INT, PA)-4 : Voice identified as cabin crew  
 TWR : Songshan Tower  
 GND : Songshan Ground  
 OTH : Communication from other flights  
 GC : Ground crew  
 ... : Unintelligible  
 () : Remarks  
 [] : Translation  
 \* : Communication not related to operation / expletive words

hh	mm	ss	Source	Context
10	41	14.6		(GE235 CVR 錄音開始) [GE235 recording begins]
1041:15.4 ~ 1054:36.6				
10	41	15.4	PA	(客艙安全廣播) [cabin safety announcement]
10	41	15.6	CAM-2	oil pressure
10	41	16.4	CAM-1	check
10	41	19.4	CAM-2	forty five starter off
10	41	20.3	CAM-1	start lights off
10	41	21.4	CAM-1	i-t-t 六七零三走 watch down [i-t-t six seven zero three go watch down]
10	41	22.3	CAM-2	六七零一 [six seven zero one]
10	41	24.2	CAM	(發動機啟動聲響) [sound of engine start]
10	41	29.8	CAM-1	許可後推 [pushback granted]
10	41	30.6	CAM-2	許可



hh	mm	ss	Source	Context
				<i>[granted]</i>
10	41	31.2	INT-1	ground 外電拆除煞車收鼻輪轉向 off 許可後推么洞跑道 <i>[ground external power off brake release nose wheel steering off pushback granted runway one zero]</i>
10	41	35.7	GC	拆外電源 <i>[external power off]</i>
10	41	37.1	CAM-1	好 before propeller rotation checklist <i>[okay before propeller rotation checklist]</i>
10	41	38.5	CAM-2	okay c-d-l-s
10	41	40.5	CAM-1	on
10	41	41.3	CAM-2	f-m-s take off data
10	41	42.5	CAM-1	confirmed
10	41	43.2	CAM-2	confirmed 了 <i>[confirmed]</i>
10	41	44.1	CAM-2	tail trims 一點零 <i>[tail trims one point zero]</i>
10	41	45.2	CAM-1	一點零 <i>[one point zero]</i>
10	41	46.2	CAM-2	check
10	41	46.9	CAM-2	他 trim 那裏可以同時這邊的 trim 跟這邊的 trim 在看 ... 知道看兩邊了喔 <i>[if it is trimmed to there they can be simultaneously watch trim here and here ... you know to watch both side right]</i>
10	41	51.0	CAM-3	我有我有看到剛剛就看這個前面都有 show 出來 <i>[i did i did see it i just saw it a moment ago it was shown]</i>
10	41	53.7	CAM-2	對好 <i>[yes okay]</i>
10	41	54.6	CAM-2	tail prop
10	41	55.2	CAM-1	in sight
10	41	55.8	CAM-2	doors
10	41	56.3	CAM-1	closed
10	41	56.9	CAM-2	seatbelt
10	41	57.4	CAM-1	on
10	41	58.0	CAM-2	beacon on
10	41	58.1	GND	(與其他航機通話) <i>[communication with other aircraft]</i>
10	41	58.6	CAM-1	on
10	41	58.9	CAM-2	procedure complete

hh	mm	ss	Source	Context
10	42	00.0	CAM-1	是 [yes]
10	42	01.7	INT-1	ground 可以後推了 [ground we can pushback now]
10	42	03.4	OTH	(其他航機與地面席對話) [communication between other aircraft and ground]
10	42	03.8	GC	教官稍等一下等等車子撤離 [sir wait a second wait until cars left]
10	42	03.9	CAM-3	這個與那個 [this and that]
10	42	05.1	CAM-2	你在看甚麼 [what are you looking at]
10	42	05.4	CAM-3	b-t-c 都看得出來 [b-t-c both are shown]
10	42	07.6	INT-1	喔車子謝謝 [oh cars thank you]
10	42	08.2	CAM-2	你再按一次 [you can push it again]
10	42	09.6	GC	謝謝教官喔我要後推了麻煩鬆煞車么洞跑道 [thank you sir i am going to push you back please release the brake runway one zero]
10	42	12.0	INT-1	好謝謝解二號 [okay thank you number two good to go]
10	42	12.0	CAM-3	對對對 [right right right]
10	42	13.1	CAM-2	但是我現在還沒開完車我們還不會轉 [but i have not finished engine start up yet it is not turning]
10	42	14.0	GC	好教官解二號來 [okay sir number two good to go]
10	42	15.5	CAM-2	我把二號一號開完 d-c 再按一次啊 [let me start number two number one reconnects d-c once again]
10	42	15.6	CAM-3	喔喔 okay 還有 d-c 的 d-c 的 [oh oh okay there is d-c d-c]
10	42	19.5	CAM-2	在這邊 [it is here]
10	42	20.2	CAM-1	rotation 開一號 [rotation start number one]
10	42	20.4	CAM-3	啊 d-c 的啊 [ah it is d-c]
10	42	24.1	GC	教官...來

hh	mm	ss	Source	Context
				<i>[sir ... ]</i>
10	42	27.0	CAM-1	start lights on
10	42	27.8	CAM-2	starter on
10	42	28.8	CAM-1	n-h rising
10	42	29.9	CAM	(single chime)
10	42	30.2	CAM-1	time
10	42	30.8	CAM-2	timing
10	42	31.2	CAM-2	fuel open
10	42	31.9	CAM-1	check
10	42	32.4	CAM-2	ignition
10	42	33.5	CAM-1	check
10	42	41.1	CAM-2	oil pressure 上升 <i>[oil pressure rising]</i>
10	42	42.0	CAM-1	check
10	42	42.7	CAM-2	forty five
10	42	43.3	CAM-1	start lights off
10	42	44.4	CAM-2	cut off
10	42	47.6	CAM-2	那個有的時候那個 com hatch 太早關 <i>[that sometimes com hatch is closed too early]</i>
10	42	50.6	CAM-1	是 <i>[yes]</i>
10	42	50.9	CAM-2	會那個一推上來的時候那個衝得很很大 <i>[it will when it goes up that will jump really really high]</i>
10	42	54.6	CAM-1	yah
10	42	54.9	CAM	(single chime)
10	42	55.6	CAM-2	是等它啊穩定後再關把 condition 推到 auto 之後再關這樣 <i>[wait until it stable then close it close it after you push condition to auto]</i>
10	42	59.4	CAM-1	穩定後兩個 <i>[after stable two]</i>
10	43	02.6	CAM-1	是 <i>[yes]</i>
10	43	08.7	CAM-3	這已經在放 com 的地方... <i>[it is already at com...]</i>
10	43	10.0	CAM-2	好 <i>[okay]</i>
10	43	11.8	CAM-2	好現在... 在這邊這裡是 d-c 跟 a-c 的電 <i>[okay now ... here here is d-c power and a-c power]</i>
10	43	16.0	CAM-1	對 <i>[yes]</i>

hh	mm	ss	Source	Context
10	43	16.9	CAM-2	auto 推推上去好你現在幫我看 hydraulic system page [push to auto push it up okay now you help me check hydraulic page]
10	43	21.2	CAM-2	再另外這個對 ... [and then another ...]
10	43	44.1	CAM-3	那個 com hatch 那個那個那邊可以顯示 [and that that com hatch where is it shown]
10	43	47.9	CAM-2	這邊沒辦法顯示要看那邊 [it is not shown here you have to check there]
10	43	49.7	CAM-3	只有看那邊是吧那沒有辦法顯示 [it only can check from there that cannot be shown]
10	43	50.4	CAM-2	嗯對沒有辦法沒有 [hmmm yes it cannot no]
10	43	52.6	CAM-3	我那一邊上了當著了道那沒有關我們看不到 (笑聲) [i take the bait and get possessed if that is not closed then we will not see it (laughing)]
10	43	56.3	CAM-2	對啊 [right]
10	43	56.7	GC	報告教官飛機完成請煞車 [sir aircraft is ready please brake]
10	43	58.1	INT-1	好煞車煞上安全鎖拆除人員撤離下午見 [okay brake on safety pin off staff off see you in the afternoon]
10	44	01.8	GC	...撤離完成麻煩看我們手勢回頭見 [... staff off complete please watch our gesture see you]
10	44	03.4	CAM-2	好 single channel 二號 [okay single channel number two]
10	44	04.9	CAM-1	check
10	44	09.7	CAM-2	一號 [number one]
10	44	10.3	CAM-1	check
10	44	14.3	CAM-2	low pitch
10	44	14.8	CAM-1	check
10	44	17.4	CAM-2	low pitch 二號一號 [low pitch number two number one]
10	44	17.9	CAM-1	check
10	44	21.8	CAM	(發動機轉速提高聲響) [sound of engine spool up]
10	44	22.3	CAM-2	好 b-t-c 接上 [okay connect b-t-c]
10	44	24.0	CAM-1	check before taxi procedure

hh	mm	ss	Source	Context
10	44	25.3	CAM-2	before taxi procedure
10	44	29.0	CAM	(single chime)
10	44	30.8	CAM-2	before taxi procedure complete
10	44	30.9	CAM	(single chime)
10	44	32.4	CAM-1	before taxi checklist
10	44	33.7	CAM-2	好 recall 了對 <i>[okay it is recalled right]</i>
10	44	36.9	CAM-2	好 f-w-s <i>[okay f-w-s]</i>
10	44	37.8	CAM-1	recall
10	44	38.3	CAM-2	propeller brake
10	44	39.0	CAM-1	off
10	44	39.5	CAM-2	cockpit com hatch
10	44	40.3	CAM-1	closed
10	44	40.8	CAM-2	condition lever 一二 <i>[condition lever one and two]</i>
10	44	41.6	CAM-1	auto
10	44	42.2	CAM-2	anti icing
10	44	42.4	OTH	(與 GND 通話) <i>[communication between other aircraft and ground]</i>
10	44	42.9	CAM-1	not required
10	44	43.7	CAM-2	anti skid
10	44	44.1	CAM-1	test
10	44	44.7	CAM-2	flaps
10	44	45.0	CAM-1	fifteen
10	44	45.7	CAM-2	nose wheel steering
10	44	46.6	CAM-1	on
10	44	47.0	CAM-2	procedure complete
10	44	47.6	GND	(與其他航機通話) <i>[communication with other aircraft]</i>
10	44	47.9	CAM-1	謝謝 <i>[thank you]</i>
10	44	53.7	OTH	(與 GND 通話) <i>[communication between other aircraft and ground]</i>
10	44	56.7	CAM	(sound of cabin call)
10	44	57.9	INT-1	嗨 <i>[hello]</i>
10	44	58.2	INT-4	教官 cabin ready <i>[sir cabin ready]</i>
10	44	58.9	RDO-2	songsan ground transasia two tree five request taxi
10	44	59.0	INT-1	好知道了謝謝

hh	mm	ss	Source	Context
				<i>[okay roger thank you]</i>
10	45	01.8	GND	transasia two tree five runway one zero taxi via whisky
10	45	05.1	RDO-2	taxi via whisky to runway one zero transasia two tree five
10	45	07.7	CAM-2	好 whisky 到么洞右邊 clear <i>[okay whisky to one zero right side is clear]</i>
10	45	09.8	CAM-1	左邊 clear <i>[left side is clear]</i>
10	45	17.0	CAM-1	taxi procedure please
10	45	18.1	CAM-2	taxi procedure
10	45	19.7	CAM-2	好[okay] f-m-s f-m-s heading select l-nav i-a-s autospeed taxi procedure complete
10	45	26.1	CAM-1	好[okay] taxi checklist
10	45	27.1	CAM-2	taxi checklist taxi take off lights
10	45	29.1	CAM-1	on
10	45	29.9	CAM-2	brakes
10	45	30.4	CAM-1	check
10	45	31.0	CAM-2	f-g-c-p f-m-a
10	45	32.0	CAM-1	heading selected i-a-s f-d left side l-nav blue one five magenta
10	45	36.3	CAM-2	好 check <i>[okay check]</i>
10	45	37.1	CAM-2	take off configuration test okay
10	45	42.8	CAM-2	take off briefing
10	45	43.8	CAM-1	好 muzha two quebec 離場 initial 五千加速高度一千一 complete <i>[okay muzha two quebec departure initial five thousand acceleration altitude one thousand one hundred complete]</i>
10	45	46.6	CAM-2	roger 是 thank you procedure complete <i>[roger yes thank you procedure complete]</i>
10	45	51.6	CAM-3	還是叫 procedure... 按... <i>[is it still called procedure... push...]</i>
10	45	52.4	GND	transasia two tree five contact tower one one eight decimal one good day
10	45	55.5	RDO-2	contact tower one one eight one transasia two tree five good day
10	46	05.5	RDO-2	songshan tower good morning transasia two tree five taxi with you
10	46	10.4	TWR	transasia two tree five songshan tower due to initial separation hold short runway one zero for landing traffic
10	46	15.7	RDO-2	hold short runway one zero transasia two tree five

hh	mm	ss	Source	Context
10	46	17.9	CAM-2	好 hold short runway [okay hold short runway]
10	46	18.3	OTH	(與 TWR 對話) [communication between other aircraft and tower]
10	46	19.3	CAM-1	是跑道外等待 [yes hold short runway]
10	46	20.3	CAM-2	喔 [oh]
10	46	23.5	TWR	(與其他航機對話) [communication with other aircraft]
10	46	24.8	CAM-2	跑道外等 [hold short runway]
10	46	26.7	CAM-1	是 [yes]
10	46	33.7	OTH	(與 TWR 對話) [communication between other aircraft and tower]
10	46	39.9	CAM-3	*教官這落地了以後啊把 f-m-s 就放在 f-m-s [sir after landing put f-m-s at f-m-s]
10	46	44.3	CAM-2	喔它嗯它調整 f-m-s 喔 [oh it yes it adjust f-m-s]
10	46	47.0	CAM-3	對對對 [right right right]
10	46	47.6	CAM-2	是 [yes]
10	46	47.9	CAM-3	這樣在 f-m-s [at f-m-s like this]
10	46	49.0	CAM-2	是 [yes]
10	46	49.3	CAM-3	先配合到它的步伐 [in coordination with its pace]
10	46	51.2	CAM-2	對啊 [yes]
10	46	54.1	CAM-2	它只是先把提前做下一步的動作這樣可是剛它開始不熟來不及所以就保持 v-o-r 靠擋後弄也可以... [it just reacts in advance the next step but if not too familiar while it is new so remain at v-o-r then do it later is fine too...]
10	47	02.6	CAM-3	對啊對啊其實我看它那 [right actually i see it]
10	47	04.8	CAM-2	因為他熟了當然知道怎麼做 [because he is so used to it he know what to do]
10	47	06.9	CAM-3	對啊下一步要幹甚麼呢

hh	mm	ss	Source	Context
				<i>[yes and what to do next]</i>
10	47	09.1	CAM-2	嗯他不熟的就先一步步先把 <i>[hmm if not familiar with it then do it step by step first]</i>
10	47	10.8	CAM-3	因他扭那個動作好像都連你這個這個都不知道轉過去啊 <i>[because he turned it as if and even you do not know to turn it]</i>
10	47	14.6	CAM-2	喔 <i>[oh]</i>
10	47	15.0	CAM-3	(笑聲) <i>[(laughing)]</i>
10	47	16.7	CAM-2	我們這個都是太快了因為你剛剛開始使用這個最精準 <i>[we do this too quickly because you just begins it is more precise to use this]</i>
10	47	20.3	CAM-3	對啊一步一步啊我就是說我們是比較慢其實說老外就很給你時間 <i>[oh yes step by step i i mean we are slower and actually for foreigners give you a lot of time]</i>
10	47	25.2	CAM-2	給你時間啊 <i>[give you time]</i>
10	47	26.1	CAM-3	他給你他 <i>[they give you]</i>
10	47	26.6	CAM-2	因為他看的不是那個他看的重點不是在那邊 <i>[because he does not want to see that he does not put too much focus on that]</i>
10	47	27.8	CAM-3	...
10	47	28.9	TWR	(與其他航機對話) <i>[communication with other aircraft]</i>
10	47	32.2	CAM-2	因為教官你剛剛講到是說甚麼時候轉到 n-d 頁面當你做到這個程序 bleed valve 的情況下它會轉換成這個頁面給你看 <i>[because sir you just mentioned when to switch to n-d page when you are doing this procedure at bleed valve it will switch to this page for you]</i>
10	47	40.9	CAM	(疑似按鍵聲響) <i>[sound similar to clicking pushbutton]</i>
10	47	41.8	CAM-2	轉到這個頁面當你做到這個頁面之後呢你就檢查完了 ... 你就自己把它換到 n-d page 就好了 <i>[turn to this page when you are up to this page you are done with the check... you switch to n-d page on your own]</i>



hh	mm	ss	Source	Context
10	47	48.3	CAM-3	它是甚麼時候會轉到這個頁面你說 [again when will it switch to this page]
10	47	49.8	CAM-2	我剛就是講 bleed valve 這個我我現在示範給你看嘛 [i just said bleed valve i i will show you]
10	47	51.7	CAM-3	... bleed valve 是不是啊 [...is it bleed valve]
10	47	53.5	CAM-2	啊我我現在試給你看 [ah i now will show you]
10	47	54.6	CAM-3	你按到它 bleed valve 它就會轉過去是不是啊 [when you proceed to bleed valve it will switch over right]
10	47	55.5	CAM-2	嘎呃 a little 啊 air flow 那邊啊這邊轉它這邊它會它先不會的那一種 [ah uh a little as for air flow if i turn this then here it would will it not]
10	48	02.4	CAM-3	你沒有放 system 頁面 [you did not display system page]
10	48	03.9	CAM-2	嘎喔對喔對剛好在 system 頁面這邊 [uh oh yes oh yes it is right at the system page]
10	48	08.6	CAM-2	等一下喔我先跳回這個頁面我剛在這邊嘛這樣 [wait a second let me jump back this page where i was]
10	48	10.7	CAM-3	欸啊 [hey uh]
10	48	15.4	CAM-2	...這樣自己做 [... like this will do on its own]
10	48	19.7	CAM-2	(台語)抱歉抱歉 [sorry sorry]
10	48	20.3	CAM-3	你只要按到這邊你啊 [you only have to press here you uh]
10	48	23.1	CAM-2	我剛在 air flow air flow 那邊好像就會這樣跳了 [i was at the air flow air flow page and it would switch like this]
10	48	23.5	CAM-3	... 呃 [... uh]
10	48	28.7	CAM-2	等一下 [wait a second]
10	48	28.9	CAM-3	現在怎麼辦這個時候才轉轉過去 [what to do now right now it just switched]
10	48	31.5	CAM-2	好的好先等一下喔我再轉另外一個頁 system [okay okay wait a second let me switch to another page system]

hh	mm	ss	Source	Context
10	48	35.0	CAM-2	好 [okay]
10	48	36.5	CAM-2	不好意思 *教官 [sorry sir]
10	48	37.6	CAM-1	hey 怎樣 [hey what's up]
10	48	37.8	CAM-2	對啊我在給它測試這樣 [oh yah i want to give it a check]
10	48	40.6	CAM-1	沒問題 [no problem]
10	48	41.0	CAM-2	好 [okay]
10	48	42.0	CAM-2	等一下它它跳到 air flow 的時候就會自己轉換 [wait a second it it will automatically switch when jumping to air flow page]
10	48	44.5	CAM-3	嘎呃 air flow 嗯 [uh uh air flow hmmm]
10	48	46.1	CAM-2	它可以看它都可以看啊我們平常有 high 跟 low 嘛 [it will show it will show normally it would be high or low]
10	48	49.6	CAM-3	嗯 high 是甚麼樣子 [hmm so what does is look like when at high]
10	48	51.6	CAM-2	high 它變成藍藍 air flow 這邊 [for high it will turn blue blue here air flow]
10	48	53.5	CAM-3	啊有一個 high high 長什麼樣子看看 [ah there is a high what does it look like check it out]
10	48	58.8	CAM-3	因為它這個轉過去 [because it this switch it over]
10	49	00.8	CAM-2	它自己跳過去了跳到這一邊之後呢你做到這個程序你這個呢 [it switched over automatically after switching over here you proceed to this procedure you uh]
10	49	04.9	CAM-3	然後這個 bleed valve 這個時候呢 [then the bleed valve and now]
10	49	07.4	CAM-2	嗯 [hmmm]
10	49	07.7	CAM-3	它還是保持 [it will remain]
10	49	08.3	CAM-2	它還是會保持它就不會跳了 [it will remain it will not switch]
10	49	09.2	CAM-3	... 就可以轉過去是吧 [... will switch over right]

hh	mm	ss	Source	Context
10	49	10.7	CAM-2	這邊就要靠自己用手動的方式了 <i>[here you have to do it manually]</i>
10	49	11.0	CAM-3	嗯嗯嗯 <i>[hmmm hmmm hmmm]</i>
10	49	14.3	CAM-3	就是那 <i>[this is it]</i>
10	49	15.0	CAM-2	對啊 <i>[yes]</i>
10	49	18.9	CAM-2	好教官不好意思冒犯了 <i>[all right sir excuse me for disturbing you]</i>
10	49	20.9	CAM-3	沒有沒有沒有沒有沒有沒有我不好意思啊我要問 <i>[no no no no not at all i shall say excuse me instead it is me who asked help]</i>
10	49	23.9	CAM-2	嗯 <i>[hmmm]</i>
10	49	24.7	CAM-3	...
10	49	24.9	CAM-2	我是冒犯了 *教官打斷他的呃抱歉 <i>[oh i meant to apologize to captain for interrupting his uh sorry for that]</i>
10	49	28.0	CAM-1	我在放空你們繼續繼續放空 <i>[i was in numb you guys can continue in numbness]</i>
10	49	39.2	CAM-1	(疑似伸懶腰聲音) <i>[sound similar to yawning while stretching]</i>
10	50	08.2	TWR	transasia two tree five line up and wait runway one zero
10	50	11.2	RDO-2	line up and wait runway one zero transasia two tree five
10	50	13.6	CAM-1	進跑道等待 <i>[line up runway and wait]</i>
10	50	13.8	CAM-2	他許可進跑道 <i>[it grants to line up runway]</i>
10	50	16.0	PA-1	cabin crew prepare for take off
10	50	18.4	CAM-1	哇 before take off procedure <i>[wow before take off procedure]</i>
10	50	20.8	CAM-2	好 roger <i>[okay]</i>
10	50	23.1	CAM-2	gust lock 我就會鬆掉它同時打開 radar <i>[gust lock i will release it and open radar]</i>
10	50	26.3	CAM-3	這是一個一連串 <i>[these are actions in a row]</i>
10	50	27.3	CAM-2	一連串動作就這樣就好了好 before take off left side spoiler up <i>[a series of actions like these and we are done now okay before take off left side spoiler up]</i>

hh	mm	ss	Source	Context
10	50	30.4	PA-4	各位貴賓我們即將起飛請您確實扣緊您的安全帶謝謝 (台語)各位貴賓我們即將起飛請您確實扣緊您的安全帶感謝 <i>[ladies and gentlemen we will be taking off shortly please fasten your seatbelt thank you (repeat in Taiwanese)]</i>
10	50	32.2	CAM-1	left up
10	50	33.1	CAM-2	right side spoiler up
10	50	34.4	CAM-1	lights on
10	50	34.6	CAM-2	lights on
10	50	37.4	CAM-2	因為剛好那個比較順手嘛這樣做好 before 嗯 before take off procedure complete <i>[because it is right at that doing this way makes it more smoothly okay before uh before take off procedure complete]</i>
10	50	40.2	TWR	(與其他航機對話) <i>[communication with other aircraft]</i>
10	50	42.9	CAM-1	before take off checklist
10	50	44.2	CAM-2	跑道是么洞 verified <i>[runway one zero verified]</i>
10	50	45.5	OTH	(與 TWR 對話) <i>[communication between other aircraft and tower]</i>
10	50	46.0	CAM-1	么洞 verified <i>[one zero verified]</i>
10	50	46.8	CAM-2	gust lock
10	50	47.5	CAM-1	released
10	50	48.1	CAM-2	flight control
10	50	49.0	CAM-1	check
10	50	49.4	CAM-2	transponder tcas
10	50	50.7	CAM-1	check
10	50	51.6	CAM-2	air flow
10	50	52.3	CAM-1	normal
10	50	52.9	CAM-2	現在看那個 normal 呃有沒有跳回來好 bleed valves <i>[now watch that normal uh did it switch back good bleed valves]</i>
10	50	56.0	CAM-1	on
10	50	57.2	CAM-2	external lights
10	50	58.3	CAM-1	on
10	50	59.0	CAM-2	when line up standby f-d bar 我就這樣換回來這樣 <i>[when line up standby f-d bar i will switch it back like this]</i>
10	51	02.4	CAM-3	這樣子喔換回來 line up standby <i>[switch it back like this line up standby]</i>

hh	mm	ss	Source	Context
10	51	07.5	CAM-3	而且 line up 這 when line up standby 是不是啊 [and line up this when line up standby isn't it]
10	51	09.7	CAM-2	啊對 standby 對啊那這個要等到 when line up [oh yes standby yes that has to wait until when line up]
10	51	12.5	CAM-3	沒有...這句話怎麼講的 line up 等待 [no... what does that mean line up and wait]
10	51	12.7	TWR	transasia two tree five runway one zero wind one zero zero degree niner knots cleared for take off
10	51	15.2	CAM-2	等一下 [wait a second]
10	51	18.1	CAM-1	...
10	51	18.9	RDO-2	cleared for take off runway one zero transasia two tree five
10	51	23.4	CAM-2	好許可起飛了 [ok cleared for take off]
10	51	23.8	CAM-1	許可起飛 [cleared for take off]
10	51	28.9	CAM-2	好 f-d bar [okay f-d bar]
10	51	29.7	CAM-1	center
10	51	30.2	CAM-2	center
10	51	31.6	CAM-2	rudder cam
10	51	32.4	CAM-1	center
10	51	33.9	CAM-2	center procedure complete
10	51	35.4	CAM-1	yes sir
10	51	35.8	CAM-2	好 [okay]
10	51	35.9	CAM-1	五么分 v one 么洞六 [time five one v one one zero six]
10	51	36.6	CAM-2	嗯五么分 roger check [hmmm time five one roger check]
10	51	39.6	CAM	(發動機轉速提高聲響) [sound of engine spool up]
10	51	42.4	CAM-2	欸 [hey]
10	51	42.8	CAM-1	欸 [hey]
10	51	43.3	CAM-2	沒有 a-t-p-c-s armed [no a-t-p-c-s armed]
10	51	44.5	CAM-1	是喔 [really]

hh	mm	ss	Source	Context
10	51	46.2	CAM-2	好 take off inhibit [okay take off inhibit]
10	51	47.7	CAM-1	take off inhibit
10	51	48.4	CAM-2	好 [okay]
10	51	48.7	CAM-1	好繼續起飛 [ok continue to take off]
10	51	49.2	CAM-2	我們繼續走喔 seventy [we will continue seventy]
10	51	50.6	CAM-1	seventy i have control
10	51	50.6	OTH	(其他航機通話) [communication between tower and other aircraft]
10	51	51.5	CAM-2	喔有啊 a-t-p-c-s armed 有 [oh there it is a-t-p-c-s armed]
10	51	53.7	TWR	(與其他航機對話) [communication with other aircraft]
10	51	57.9	CAM-2	engine instrument check normal
10	51	58.8	CAM-1	v one v r
10	51	59.4	CAM-2	v one v r
10	52	00.2	CAM-1	rotate
10	52	01.7	CAM	(pitch trim 聲響) [sound of pitch trim]
10	52	03.7	CAM-2	好 positive rate [okay positive rate]
10	52	05.0	CAM-1	gear up
10	52	05.4	CAM-2	gear up
10	52	07.4	CAM	(pitch trim 聲響) [sound of pitch trim]
10	52	07.8	CAM-1	l nav green
10	52	09.0	CAM-2	check
10	52	13.9	CAM-1	au autopilot on
10	52	15.5	CAM-2	autopilot on
10	52	16.0	CAM	(pitch trim 聲響) [sound of pitch trim]
10	52	17.1	CAM-1	a-p green
10	52	17.7	CAM-2	check
10	52	20.8	CAM-2	gear up set
10	52	21.1	CAM-1	... check
10	52	32.1	CAM-2	他可能 throttle 補一下就有了呢大概 [it came back after we advanced the throttle uh maybe]
10	52	33.6	CAM-1	yes

hh	mm	ss	Source	Context
10	52	33.8	TWR	transasia two three five contact taipei approach one one niner decimal seven good day
10	52	34.3	CAM-2	yah...
10	52	36.7	CAM	(bleed valve 關閉聲響) [sound of bleed valve closure]
10	52	37.7	RDO-2	one one niner seven transasia two tree five good day
10	52	38.3	CAM	(master warning 至 1052:40.0) [sound of master warming until 1052:40.0]
10	52	39.4	CAM-2	欸看一下來欸 [hey take a look hey]
10	52	39.4	CAM-1	* 好 i i have control [* okay i i have control]
10	52	41.4	CAM	(自動駕駛解除聲響) [sound of autopilot disengagement]
10	52	41.6	CAM-2	you have control
10	52	43.0	CAM-1	我把一號發動機收回來 [i will pull back engine one throttle]
10	52	43.0	CAM	(pitch trim 聲響) [sound of pitch trim]
10	52	43.6	CAM-2	等一下 cross check [wait a secondcross check]
10	52	44.8	CAM	(sound of single cavalry charge)
10	52	46.1	CAM-1	heading mode
10	52	46.6	CAM-2	heading mode
10	52	47.3	CAM-1	好我們繼續 [okay let us continue]
10	52	48.4	CAM-2	heading mode 嘛還是 [heading mode or]
10	52	48.5	CAM	(single chime)
10	52	50.0	CAM-1	好 [okay]
10	52	50.1	CAM-2	我們... 呃低於兩千五我們 heading 轉去啊那個 [we are... uh lower than twenty five hundreds we turn the heading to that]
10	52	54.1	CAM-1	繼續 [continue]
10	52	54.3	CAM-2	洞洞九五那邊 [zero zero niner five]
10	52	55.6	CAM-1	好 [okay]
10	52	56.3	CAM-2	... heading select
10	52	57.4	CAM-1	check

hh	mm	ss	Source	Context
10	52	58.5	CAM-1	那我速度 [and speed]
10	52	58.9	CAM-2	好 check [okay check]
10	52	58.9	CAM	(pitch trim 聲響) [sound of pitch trim]
10	52	59.4	CAM	(sound similar to single chime)
10	53	00.4	CAM-2	好 engine flameout check [okay engine flameout check]
10	53	01.6	CAM-1	check
10	53	01.8	CAM	(pitch trim 聲響) [sound of pitch trim]
10	53	02.2	CAM-2	check up trim 有 [check up trim yes]
10	53	04.1	CAM-2	auto feather 有 [auto feather yes]
10	53	05.2	CAM-1	好 [okay]
10	53	05.5	CAM-2	速度先注意一下 [watch the speed]
10	53	06.4	CAM-1	number one 收回來 [pull back number one]
10	53	07.7	CAM-2	好現在是確定二號 engine flameout [okay now number two engine flameout confirmed]
10	53	08.6	CAM	(sound of triple clicks)
10	53	09.3	CAM-1	好 [okay]
10	53	09.9	CAM	(失速警告聲響至 1053:10.8) [sound of stall warning until 1053:10.8]
10	53	10.7	CAM-2	等一下他 [wait a second it]
10	53	12.1	CAM-1	* 有地障 [* terrain ahead]
10	53	12.1	CAM-2	好低... [okay lower...]
10	53	12.9	CAM-3	你低了 [you are low]
10	53	12.6	CAM	(失速警告聲響至 1053:18.8) [sound of stall warning until 1053:18.8]
10	53	12.8	CAM	(stick shaker 聲響至 1053:18.8) [sound of stick shaker until 1053:18.8]
10	53	13.7	CAM-2	好推推回



hh	mm	ss	Source	Context
				<i>[okay push push back]</i>
10	53	15.0	CAM-1	shut
10	53	15.6	CAM-2	等一下 ...油門 <i>[wait a second ... throttle]</i>
10	53	17.9	CAM-2	油門 <i>[throttle]</i>
10	53	19.6	CAM-1	number one
10	53	20.2	CAM-2	number feather
10	53	21.1	CAM-1	feather shut off
10	53	21.4	CAM	(失速警告聲響至 1053:23.3) <i>[sound of stall warning until 1053:23.3]</i>
10	53	21.4	CAM	(stick shaker 聲響至 1053:23.3) <i>[sound of stick shaker until 1053:23.3]</i>
10	53	21.7	CAM-2	okay
10	53	22.6	CAM-1	呃 number one <i>[uh number one]</i>
10	53	25.3	CAM-1	好我繼續飛啊 <i>[okay i have control]</i>
10	53	25.3	CAM	(single chime)
10	53	25.7	CAM	(失速警告聲響至 1053:27.3) <i>[sound of stall warning until 1053:27.3]</i>
10	53	25.7	CAM	(stick shaker 聲響至 1053:27.3) <i>[sound of stick shaker until 1053:27.3]</i>
10	53	26.2	CAM-2	好你來飛 <i>[okay you have control]</i>
10	53	27.4	CAM	(sound of one click)
10	53	27.6	CAM	(single chime)
10	53	28.1	CAM-2	好跟著 heading bug <i>[okay follow the heading bug]</i>
10	53	29.7	CAM-1	跟著 heading bug 喔 <i>[follow the heading bug oh]</i>
10	53	30.4	CAM-2	好 heading autofeather 唉唷 <i>[okay heading autofeather ouch]</i>
10	53	32.1	CAM-1	check
10	53	34.9	RDO-2	tower transasia two tree five mayday mayday engine flameout
10	53	39.4	TWR	transasia two tree five please try again contact taipei approach one one niner decimal seven
10	53	43.1	CAM-2	好現在航向轉一個洞九五 <i>[okay now heading turn to zero niner five]</i>
10	53	45.4	CAM-1	check

hh	mm	ss	Source	Context
10	53	46.4	CAM-1	autopilot 接上 [engage autopilot]
10	53	47.0	CAM-2	好的 autopilot 好 [okay autopilot okay]
10	53	48.7	CAM-1	a p green
10	53	49.7	CAM-2	a p green
10	53	50.7	CAM	(pitch trim 聲響) [sound of pitch trim]
10	53	51.0	CAM-2	trim 打好... [put the trim right]
10	53	53.5	CAM-3	怎麼這樣子勒 [how come it becomes like this]
10	53	54.5	CAM-1	好你負責對外 [okay you are in charge of communication]
10	53	55.6	CAM-2	好我來對啊 [okay will do]
10	53	55.9	CAM	(失速警告聲響至 1053:59.7) [sound of stall warning until 1053:59.7]
10	53	55.9	CAM	(stick shaker 聲響至 1053:59.7) [sound of stick shaker until 1053:59.7]
10	53	56.7	CAM-2	不要帶太高不要太高 [don't pull too high not too high]
10	53	58.7	CAM-1	我現在是 autopilot autopilot 再接一次 [i now have autopilot reconnect the autopilot]
10	54	00.0	CAM	(autopilot 解除聲響) [sound of autopilot disengagement]
10	54	00.3	CAM-2	好再接一次 [okay reconnect it one more time]
10	54	03.4	CAM-2	疑沒有 [eh no]
10	54	04.1	CAM	(autopilot 解除聲響) [sound of autopilot disengagement]
10	54	04.2	CAM-1	我先轉... [i will turn...]
10	54	05.0	CAM-2	兩邊都沒有... [both sides ... lost]
10	54	06.1	CAM	(失速警告聲響至 1054:10.1) [sound of stall warning until 1054:10.1]
10	54	06.1	CAM	(stick shaker 聲響至 1054:10.1) [sound of stick shaker until 1054:10.1]
10	54	06.5	CAM	(sound of two clicks)
10	54	07.0	CAM-2	沒有 engine flameout both sides 沒有了

hh	mm	ss	Source	Context
				<i>[no engine flameout we lost both sides]</i>
10	54	08.9	CAM-1	好 <i>[okay]</i>
10	54	09.2	CAM-1	重新開車 <i>[restart the engine]</i>
10	54	09.9	CAM-2	好 <i>[okay]</i>
10	54	10.2	CAM	five hundred
10	54	10.4	CAM	(autopilot 解除聲響) <i>[sound of autopilot disengagement]</i>
10	54	11.4	CAM-1	重新開車 <i>[restart the engine]</i>
10	54	11.9	CAM-2	okay
10	54	12.4	CAM	(失速警告聲響至 1054:21.6) <i>[sound of stall warning until 1054:21.6]</i>
10	54	12.4	CAM	(stick shaker 聲響至 1054:21.6) <i>[sound of stick shaker until 1054:21.6]</i>
10	54	14.1	CAM-1	重新開車 <i>[restart the engine]</i>
10	54	14.5	CAM-2	roger
10	54	16.2	CAM-2	button on
10	54	17.7	CAM-1	重新開車 <i>[restart the engine]</i>
10	54	18.3	CAM-2	okay
10	54	18.7	TWR	(與其他航機通話) <i>[communication with other aircraft]</i>
10	54	20.4	CAM-2	okay
10	54	21.3	CAM-1	重新開車 <i>[restart the engine]</i>
10	54	21.8	CAM-2	roger
10	54	21.9	CAM	(autopilot 解除聲響) <i>[sound of autopilot disengagement]</i>
10	54	22.6	CAM-2	呃要往左邊哪 <i>[uh to the left hand side]</i>
10	54	23.2	CAM	(失速警告聲響至 1054:33.9) <i>[sound of stall warning until 1054:33.9]</i>
10	54	23.5	CAM	(stick shaker 聲響至 1054:33.9) <i>[sound of stick shaker until 1054:33.9]</i>
10	54	24.0	CAM-1	重新開車 <i>[restart the engine]</i>
10	54	25.5	CAM-2	開不到 <i>[cannot restart it]</i>

hh	mm	ss	Source	Context
10	54	26.3	CAM-1	重新開車 <i>[restart the engine]</i>
10	54	27.1	CAM-1	哇油門收錯了 <i>[wow pulled back the wrong side throttle]</i>
10	54	30.5	CAM-1	重新開車 <i>[restart the engine]</i>
10	54	30.9	CAM-2	啊 <i>[ah]</i>
10	54	31.8	CAM-3	impact impact brace for impact
10	54	34.0	CAM-1	啊* <i>[ah]</i>
10	54	34.1	CAM	pull up
10	54	34.2	CAM	(sound of cavalry charge)
10	54	34.6	CAM	(master warning)
10	54	34.8	CAM	(不明聲響) <i>[unidentified sound]</i>
10	54	35.4	CAM-2	...
10	54	35.9	CAM	pull up
10	54	36.6		CVR 錄音終止 <i>[CVR recording ends]</i>

Intentionally Left Blank

## Appendix 3 FDR Data Plots

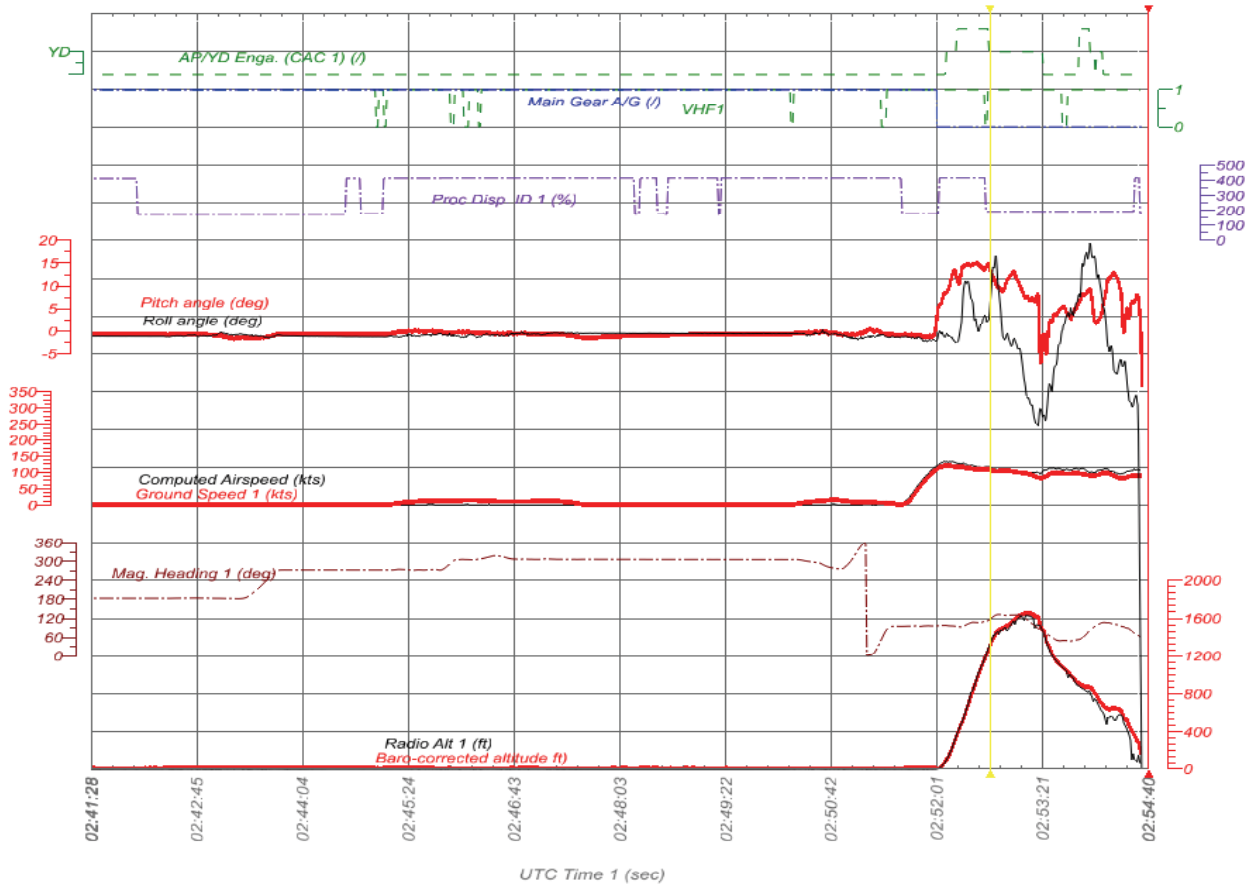

Figure A3-1 GE235 FDR selected parameters plot (1)

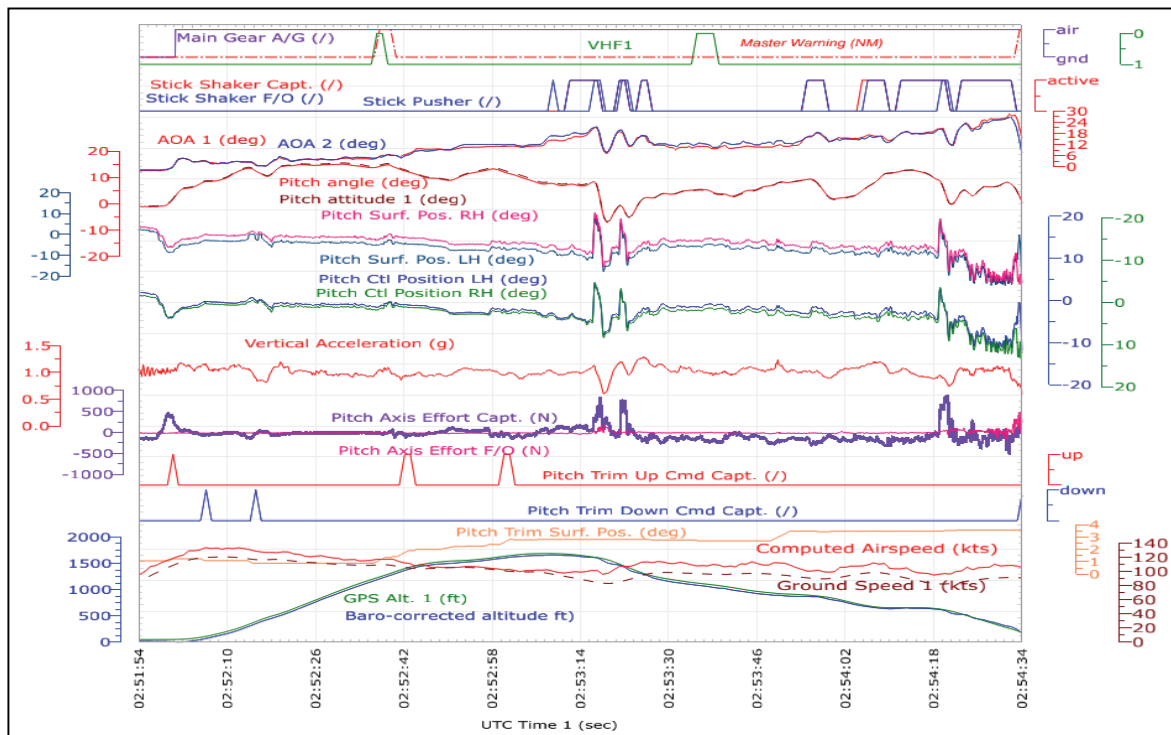

Figure A3-2 GE235 FDR selected parameters plot (2)

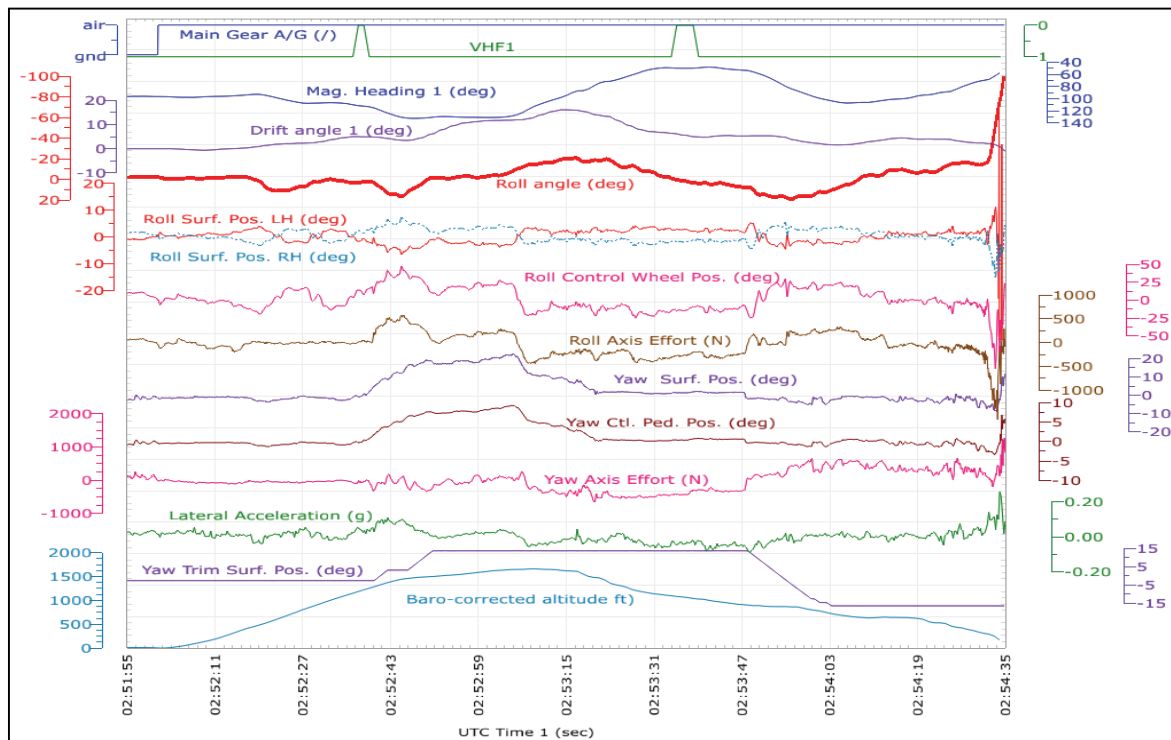

Figure A3-3 GE235 FDR selected parameters plot (3)

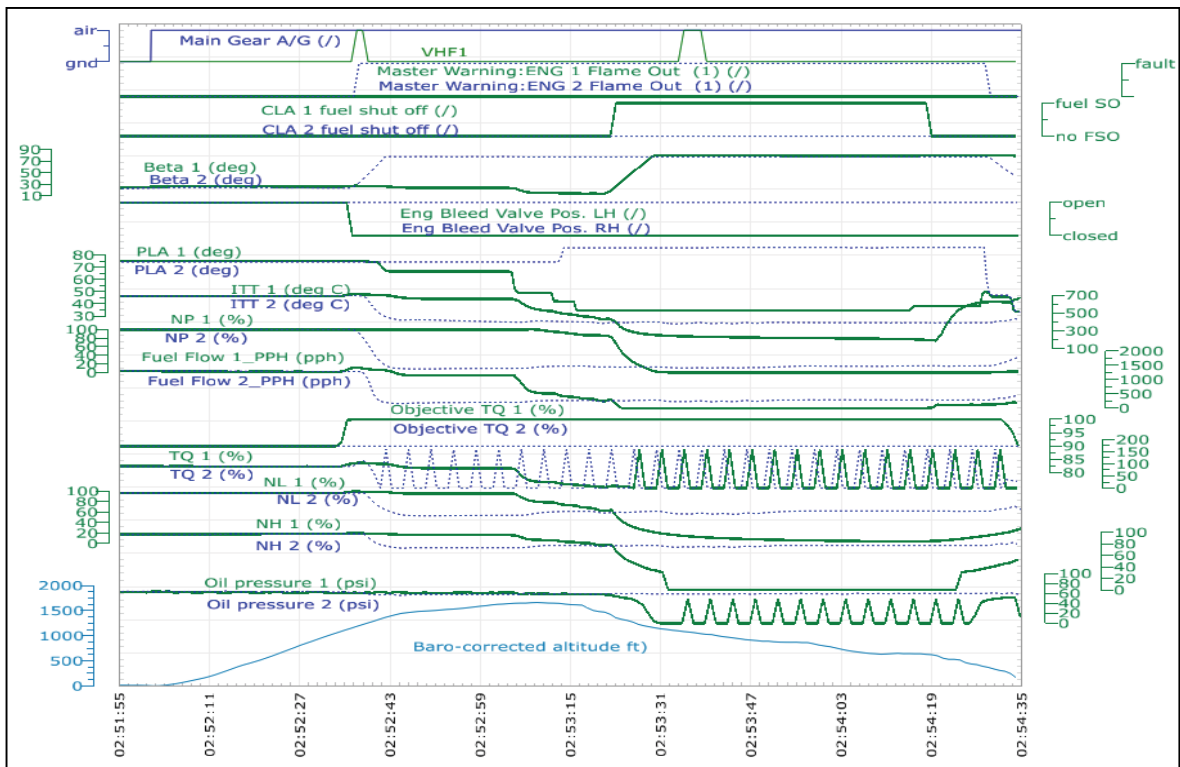

Figure A3-4 GE235 FDR parameters plot (engine related)

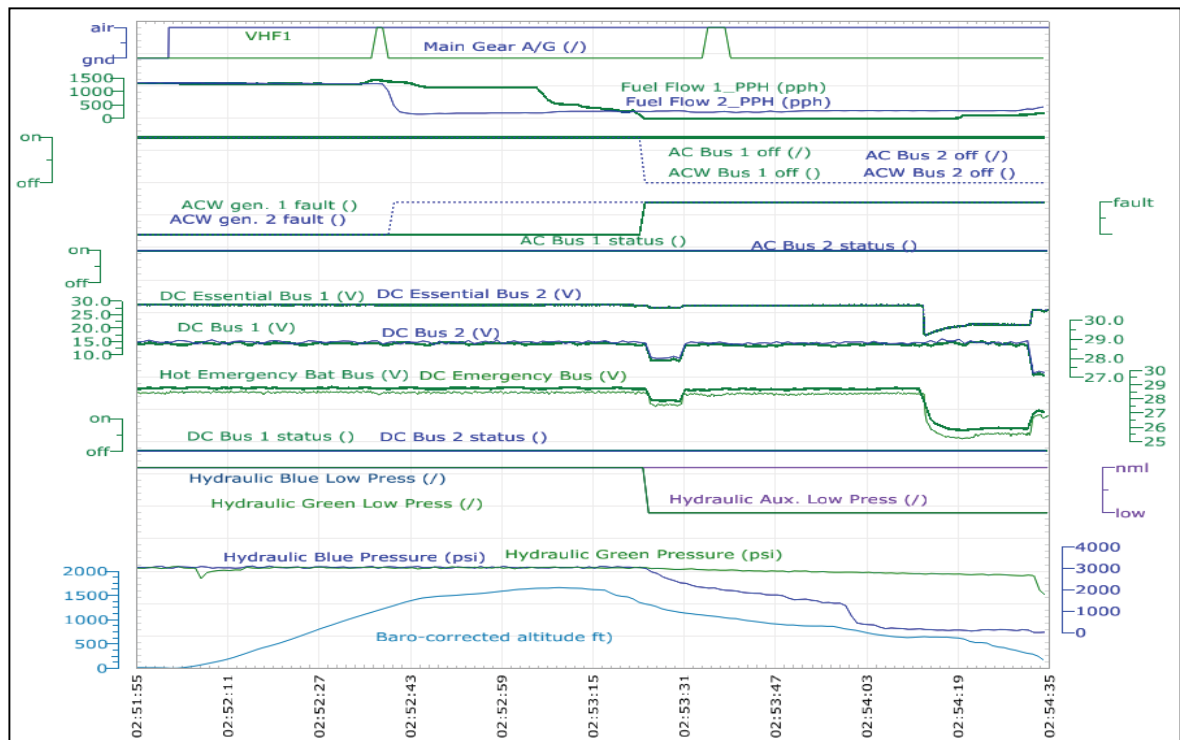

Figure A3-5 GE235 FDR parameters plot (electrical related)



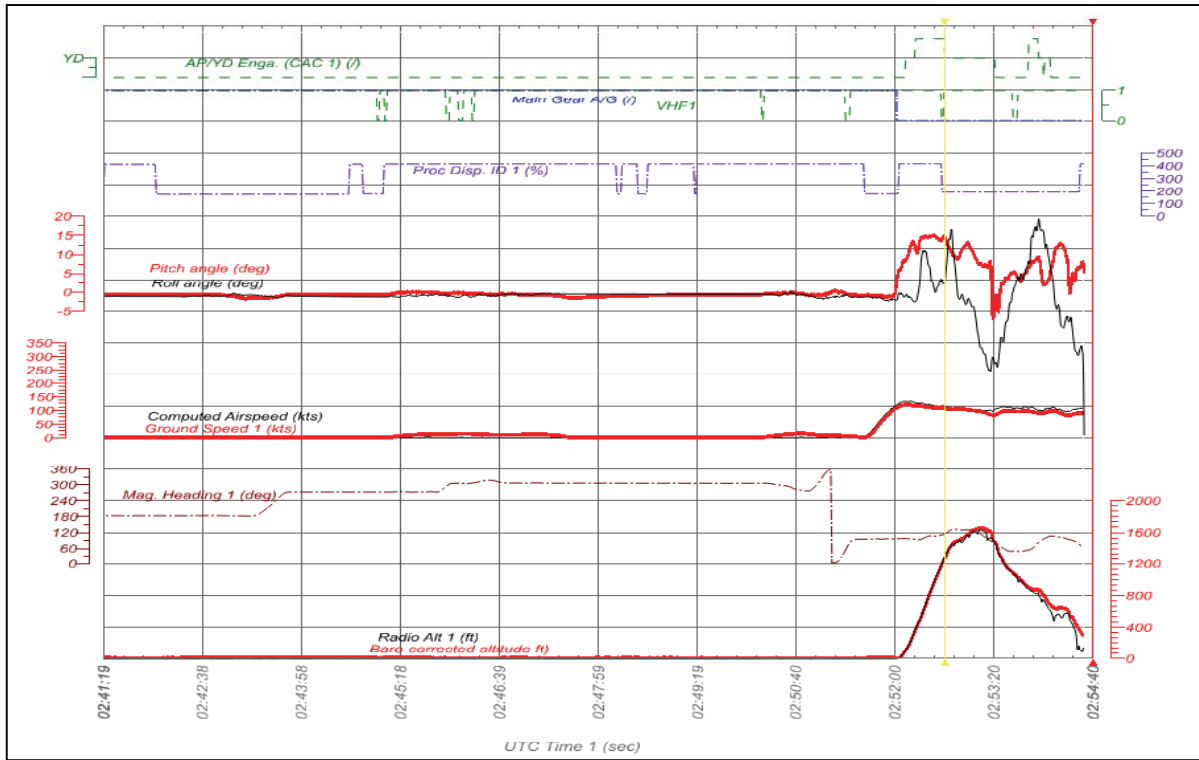

Figure A3-6 GE235 QAR selected parameters plot (entire flight)

## Appendix 4 Engine Sensors Test Summary

Engine Number 1			
Accessory	P/N	S/N	Result
Torque sensor left	3073471-01	CH1282	Satisfactory with CMM
Torque sensor right	3073471-02	CH1734	1.Insulation check satisfactory (note 1) 2.With 639RPM, the test point voltage was 1.39 volts slightly below minimum limit of 1.5 volts
Np speed sensor	3077761-01	CH2615	1.Insulation check satisfactory (note 1) 2.Resistance at each coil and between the coils and the housing was within limits but fluctuating (note 2). 3.3D X-ray of sensor indicated that one of the wires was detached from the pin.
Nh speed sensor (lower)	3077761-01	CH2595	1.Insulation check satisfactory (note 1)
Nh speed sensor (upper)	3077761-01	CH2610	1.Insulation check was 45 mega-ohms which is below minimum limit of 100 mega-ohms
Nl speed sensor	3033509H	CH21092	Satisfactory
Engine Number 2			
Accessory	P/N	S/N	Result
Torque sensor left	3073471-02	CH1468	1.Open circuit existed in a coil winding resistance check. 2.Three test point voltages at different RPM settings were below minimum limit of 1.5/8.9/8.9 volts. 3.Voltage was erratic throughout this series of tests.
Torque sensor right	3073471-02	CH1457	1.Two test point voltages at different RPM settings were slightly below minimum limit of 1.5/8.9 volts.
Np speed sensor	3077761-01	CH2128	Satisfactory
Nh speed sensor (lower)	3077761-01	CH2106	Satisfactory
Nh speed sensor (upper)	3077761-01	CH2108	Satisfactory
Nl speed sensor	3033509M	CH20768	Satisfactory
Note			
1.This test point was repeated after heating the sensor at 100° C then allowing it to cool to room temperature resulting in acceptable resistance.			
2.Following heating of the sensor to 100° C and allowing it to cool to room temperature there were no open circuit existed.			

Intentionally Left Blank

## Appendix 5 TNA ATR72-600 Difference Training Syllabus

ATR 600 Difference Course One week				
Publication date: 08/11/13				
DAY1	DAY2	DAY3	DAY4	DAY5
NAS presentation Planning Interactive tools (2H00)	■ -FLIGHT INSTRUMENTS -INTEGRATED SYSTEMS	■ -FWS -AFCS		
VHP1 Briefing (0H30)	VHP2 Briefing (0H30)	VHP3 Briefing (0H30)	VHP4 Briefing (0H30)	FFS Briefing (1H00)
VHP (3H00)	VHP (3H00)	VHP (3H00)	VHP (3H00)	FFS (4H00)
NAS presentation --- FMS initialization Lateral/Vertical revision pages presentation Debriefing (0H30)	full cockpit preparation (SOP) Complete System pages description --- FMS practice (speed configurations) Debriefing (0H30)	Failures treatment  Flaps Unlock DC Gen fault IOM failures FMS failures DU failures Engine Flame Out FWS failure FMS msg (INTEG, Unable RNP, D-R) Emergency Evacuation Debriefing (0H30)	NAVIGATION (LFBO → LFMT)  FMS practice Non Precision Approach  Debriefing (0H30)	Severe Icing Stall EFATO Go-Around twin ENG Go-Around Single ENG Debriefing (1H00)
■ - GLASS COCKPIT FAMILIARISATION -VCP	CRM (2h00)		■ -NAVIGATION SYSTEM -COMMUNICATION	

All ■ modules are flexible therefore, they must be studied by the end of the week under trainee responsibility.

AFCS= Automatic Flight Control System    EFATO=engine flameout at take-off    FFS=full flight simulator  
 FWS= Flight Warning System    LMS=Learning Management Software    MFSTD= Maintenance & Flight  
 Synthetic Training Device    NAS=New Avionic Suite    NPA=Non Precision Approach    VHP=Virtual  
 Hardware Platform    VCP= Virtual Control Panel    CRM= Crew Resource Management

Intentionally Left Blank

## Appendix 6 AFM Supplement 7\_02.10

 ATR 72 A  AFM	<b>SUPPLEMENTS</b>		<b>7_02.10</b>	
	SUPPLEMENT N° 10		PAGE : 1	001
			DGAC APPROVED	FEB 01
<b><u>DISPATCH WITH ATPCS OFF</u></b>				
R	<p>AFU is considered operative. If not, refer to the connected procedure.</p> <ul style="list-style-type: none"> <li>- Select ATPCS OFF and BLEED VALVES OFF</li> <li>- Increase V1 limited by VMCG by 5 kt</li> <li>- Increase VR by 2 kt</li> <li>- Increase VMCA by 3 kt. Check VR and V2</li> <li>- Increase VMCL by 3 kt</li> <li>- Check ATPCS inoperative effect on TOR, TOD and 2nd segment</li> <li>- Apply RTO power by pushing both PLs up to the ramp</li> <li>- After take off set both PLs into the notches, then apply CLIMB SEQUENCE</li> <li>- BLEED VALVES ..... ON</li> </ul> <p><u>NOTE</u> :In case of engine failure after V1 do not reduce PL below 45° of PLA before feathering</p>			
Model : 212 A				

Intentionally Left Blank

## Appendix 7 TNA ATR72-600 Normal Checklist

 <b>ATR72-600 NORMAL CHECKLIST</b>		REV 04 17 NOV 2014
TAKE OFF BRIEFING		APPROACH BRIEFING
<ul style="list-style-type: none"> <li>• Aircraft Technical Status</li> <li>• Conditions at departure airport (NOTAM, weather, runway condition, ground movement, obstacle info.)</li> <li>• Rwy excursion risk assessment</li> <li>• Normal departure procedure</li> <li>• Check "ATPCS OFF(INOP)" Take Off Weight</li> <li>• Emergency procedure               <ul style="list-style-type: none"> <li>– Red warning before V1:                   <ul style="list-style-type: none"> <li>* On ground emergency EVAC PROC.</li> </ul> </li> <li>– Red warning after V1                   <ul style="list-style-type: none"> <li>* Acceleration altitude</li> <li>* Single engine operation proc.</li> </ul> </li> </ul> </li> <li>• Checklist sequence if emergency exit  <u>Emergency</u>   <u>Normal</u>   <u>Abnormal</u> </li> </ul>		<ul style="list-style-type: none"> <li>• Aircraft Technical Status and NAV status</li> <li>• Conditions at destination airport (NOTAM, weather, runway data (length, surface condition, braking action, landing taxi route, lighting))</li> <li>• Landing performance (landing distance, Go-around climb gradient))  <u>Note:</u>  <i>add 15% to the In-flight LDG Dist. except in emergency.</i> </li> <li>• Rwy excursion risk assessment</li> <li>• Sudden occurrence handling proc.</li> <li>• Approach chart (date, no. , App. Type)</li> <li>• Transition Level, MSA</li> <li>• Primary App. NAV freq. and course</li> <li>• Approach route course</li> <li>• FAF (or FAP) altitude</li> <li>• DH or MDA and missed approach point               <ul style="list-style-type: none"> <li>– Missed approach procedure                   <ul style="list-style-type: none"> <li>* Alternate</li> <li>* Extra &amp; Divert fuel</li> </ul> </li> <li>– Go around procedure</li> </ul> </li> </ul>
<b>TAILWIND LIMITATION:</b> (Based on AFM 2.03.02 REV16)		<b>15 kts</b>
<b>CARGO DOOR LIMITATION:</b> (Based on AFM 2.05.07 REV16)		Do not operate cargo door with a crosswind component $\geq$ <b>45 kts</b>
<b>Note:</b> When entering icing conditions ( $TAT \leq 7^{\circ}\text{C}$ with visible moisture), apply the adequate icing procedures and speeds must be complied and carefully monitored.		



Intentionally Left Blank

## Appendix 8 SOP Policy Regarding the Checks Performed During TakeOff and Focus on ATPCS Check

The purpose of the Standard Operating Procedures (SOP) is to ensure the aircraft is in the appropriate configuration for all phase of flight, including take-off. By definition, any check not completed halts the procedure and take off cannot proceed.

This is the industry norm.

As per ATR SOP, Refer to FCOM 2.03.14, the above policy applies to all the below actions related to checks during the take off roll before V1:

- Check of the FMA
- Check of the ATPCS
- Check of the Engine Parameters
- Check of the Power Setting
- Check of the 70kt speed indication and associated checks (availability of both flight crew members for take off, transfer of controls)

The objective of the action line, “ATPCS ARM....CHECK then ANNOUNCE”, is to confirm the availability of the ATPCS for the take off in the actual conditions.

At take off power initiation, PL1+2 set in the notch, if the check of ATPCS armed condition is negative, ARM light not lit, means that the ATPCS is not available.

To emphasize this point, ATR issued the OEB n°27 which states: *“The ATPCS must be checked armed and announced (FCOM 2.03.14). If it is not armed while both power levers are in the notch, or in the case of intermittent arming / disarming of the ATPCS, the take off has to be interrupted, as for any other anomaly intervening during the take off run.”*

	<b>NORMAL PROCEDURES</b>	2.03.14	
	TAKE OFF	P 1	100
			DEC 13

**TAKE OFF**  
For Take Off at 100% TQ, refer to page 1A, 2A. (if applicable)

**CAUTION:**  
If operations are simultaneously conducted with High Altitude Runways (up to 11,000 ft), associated procedure(s) in 7.01.07 (refer to AFM) have also to be taken into account.

**CM1** - "TAKE OFF" ..... ANNOUNCE  
**CM1** - BRAKES ..... RELEASED  
**CM1** - PL 1 + 2 ..... SET IN THE NOTCH  
**CM1** - FMA ..... ANNOUNCE



**CM2** - FMA ..... CHECK  
**CM2** - "ATPCS ARM" ..... CHECK then ANNOUNCE  
**CM2** - ENGINE PARAMETERS ..... CHECK  
*Note : Parameters should be obtained at around 60 Kt*

ACTUAL TQ ..... MATCH TO BUG  
*Note : If necessary, adjust PLs to obtain TO TQ (bugs)*  
 RTO BUG ..... CHECK  
 NP ..... ~ 100 %  
*Note : NP = 100 % - 0.6%/-0.8%*  
 ITT ..... CHECK

**CM2** - TO INHIB ..... CHECK  
**CM2** - "POWER SET" ..... ANNOUNCE

**When reaching 70 Kt**  
**CM2** - "SEVENTY KNOTS" ..... ANNOUNCE  
**CM1** - SPEED ..... CROSS CHECK on PFD  
*And cross check speeds with IES!*

**ALL** - "I HAVE CONTROL" / "YOU HAVE CONTROL" ..... ANNOUNCE  
 - If CM1 becomes PF, CM1 announce only "I HAVE CONTROL"  
 - If CM2 becomes PF, CM1 announce "YOU HAVE CONTROL" & CM2 answer "I HAVE CONTROL"

**PNF** - "V1" ..... ANNOUNCE

R Mod 5948 + 6521

**Additional information and extracts of ATR Flight Operations Manuals relative to the ATPCS:**

As per ATR SOPs, the ATPCS availability is also monitored and checked by the means of:

- A static test prior to each take off, Refer to FCOM SOP 2.03.06 or 2.03.07
- A check of the “ARM” condition of the ATPCS prior to each take off, Refer to FCOM 2.03.14
- A dynamic test after the last flight of the day, Refer to FCOM SOP 2.03.21 & 2.03.24

If the ATPCS is not available when the flight crew takes the aircraft or during the static test, dispatch is in accordance with ATPCS MMEL dispatch conditions as well as associated maintenance and operational procedures that must be applied. Refer to MEL item 61-22-2 and AFM procedure 7-02-10.

**As a general rule, the industry norm is:**

If any of the items checked during take off, according to SOPs, is detected as not standard, the airplane condition is not satisfactory. The take off cannot be continued in the actual conditions and must be rejected.

The flight crew must return to the gate and perform the necessary maintenance checks and procedure. If any of the systems involved is confirmed not available, the associated MMEL dispatch conditions and procedures must be applied prior to any new take off attempt.

For comparison the Airbus 3xx SOP at take off are provided to show how another manufacturer deals with SOP. It has to be noted that Airbus does not list all the conditions leading to a rejected take off but write the general policy as an operating technique.

The implementation in the manufacturer FCOM of such a rejected take off procedure may clarify ATR policy.

 <b>AIRBUS</b> FOR TRAINING ONLY <b>A318/A319/A320/A321</b> FLIGHT CREW OPERATING MANUAL	<b>PROCEDURES</b> <b>NORMAL PROCEDURES</b> STANDARD OPERATING PROCEDURES - TAKEOFF
---	--

**TAKEOFF**

Applicable to: ALL

Rolling takeoff is permitted.

TAKEOFF..... ANNOUNCE  
 BRAKES..... RELEASE

**THRUST SETTING**

- If the crosswind is at or below 20 kt and there is no tailwind:

THRUST LEVERS..... FLX or TOGA

- To counter the nose-up effect of setting engine takeoff thrust, apply half forward stick until the airspeed reaches 80 kt. Release the stick gradually to reach neutral at 100 kt.
- PF progressively adjusts engine thrust in two steps:
  - from idle to about 50 % N1 (1.05 EPR).
  - from both engines at similar N1 to takeoff thrust.

- Once the thrust levers are set to FLX or TOGA detent, the captain keeps his hand on the thrust levers until the aircraft reaches V1.

- In case of tailwind or if crosswind is greater than 20 kt:

THRUST LEVERS..... FLX or TOGA

- PF applies full forward stick.
- PF sets 50 % N1 (1.05 EPR) on both engines then rapidly increases thrust to about 70 % N1 (1.15 EPR) then progressively to reach takeoff thrust at 40 kt ground speed, while maintaining stick full forward up to 80 kt. Release stick gradually to reach neutral at 100 kt.
- Once the thrust levers are set to FLX or TOGA detent, the captain keeps his hand on the thrust levers until the aircraft reaches V1.

*Note:* ENG SD page replaces WHEEL SD page on the ECAM lower display.

DIRECTIONAL CONTROL..... USE RUDDER

At 130 kt (wheel speed), the connection between nosewheel steering and the rudder pedals is removed. Therefore, in strong crosswinds, more rudder input will be required at this point to prevent the aircraft from turning into the wind.

CHRONO..... START  
 PFD/ND..... SCAN

1. Check the FMA on the PFD. The following modes are displayed: MAN TOGA (or MAN FLX xx) /SRS/RWY (or blank) / A/THR (in blue).

 <b>AIRBUS</b> FOR TRAINING ONLY <b>A318/A319/A320/A321</b> FLIGHT CREW OPERATING MANUAL	<b>PROCEDURES</b> <b>NORMAL PROCEDURES</b> STANDARD OPERATING PROCEDURES - TAKEOFF
--	--

*Note: If an ILS that corresponds to the departure runway is tuned, RWY mode appears. If not, no lateral mode appears until the aircraft lifts off.*

2. Check the FMS position on the ND (aircraft on runway centerline).

*Note: If GPS PRIMARY is not available, check the FMS position update.*

FMA..... ANNOUNCE

**BEFORE REACHING 80 KT**

TAKEOFF N1..... CHECK

*Check that the actual N1 of the individual engines has reached the N1 rating limit, before the aircraft reaches 80 kt. Check EGT.*

THRUST SET..... ANNOUNCE

PFD and ENG indications..... SCAN

*Scan airspeed, N1, and EGT throughout the takeoff.*

**REACHING 100 KT**

ONE HUNDRED KNOTS..... ANNOUNCE

- The PF crosschecks and confirms the speed indicated on the PFD
- Below 100 kt the Captain may decide to abort the takeoff, depending on the circumstances
- Above 100 kt, rejecting the takeoff is a more serious matter.

**AT V1**

V1..... ANNOUNCE

**AT VR**

ROTATION ..... ORDER

ROTATION..... PERFORM

- At VR, initiate the rotation to achieve a continuous rotation with a rate of about 3 °/s, towards a pitch attitude 15 ° (12.5 °, one engine is failed)
- Minimize the lateral inputs on ground and during the rotation, to avoid spoiler extension
- In strong crosswind conditions, small lateral stick inputs may be used, if necessary, to aim at maintaining wings level
- After lift-off, follow the SRS pitch command bar.

 <b>AIRBUS</b> FOR TRAINING ONLY <b>A318/A319/A320/A321</b> FLIGHT CREW OPERATING MANUAL	<b>PROCEDURES</b> <b>NORMAL PROCEDURES</b> <b>STANDARD OPERATING PROCEDURES - TAKEOFF</b>
---	---

<b>CAUTION</b>	If a tailstrike occurs, avoid flying at an altitude requiring a pressurized cabin, and return to the originating airport for damage assessment.
----------------	---

**WHEN POSITIVE CLIMB**

POSITIVE CLIMB..... ANNOUNCE  
 LDG GEAR UP..... ORDER  
 LDG GEAR..... SELECT UP  
 AP..... AS RQRD  
*Above 100 ft AGL, AP 1 or 2 may be engaged.*  
 FMA..... ANNOUNCE

**AT THRUST REDUCTION ALTITUDE**

THRUST LEVERS..... CL  
*Move the thrust levers to the CL detent, when the flashing LVR CLB prompt appears on the FMA. A/THR is now active.*  
*In manual flight, the pilot must anticipate the change in pitch attitude in order to prevent the speed from decaying when thrust is reduced.*  
 FMA..... ANNOUNCE  
 PACK 1 and 2 (if applicable)..... ON  
*Select PACK 1 on after CLB thrust reduction.*  
*Select PACK 2 on after flap retraction.*  
**Note:** 1. Selecting pack on before reducing takeoff thrust would result in an EGT increase.  
 2. PACK 2 may be selected earlier, but not sooner than 10 s after PACK 1 is selected on, for passenger comfort.  
 3. If packs are not switched on after the takeoff phase, an ECAM caution will be triggered.

**AT ACCELERATION ALTITUDE**

FMA..... ANNOUNCE  
*Check the target speed change from V2 + 10 to the first CLB speed (either preselected or managed).*  
**Note:** 1. When THR RED and ACC ALT are equal, the FMA will change from MAN FLX/SRS/NAV to THR CLB/CLB/NAV.  
 2. If FCU-selected altitude is equal to or close to the acceleration altitude, then the FMA will switch from SRS to ALT\*.

 <b>AIRBUS</b> FOR TRAINING ONLY <b>A318/A319/A320/A321</b> FLIGHT CREW OPERATING MANUAL	<b>PROCEDURES</b> <b>ABNORMAL AND EMERGENCY PROCEDURES</b>  <b>OPERATING TECHNIQUES</b>
---	--

<b>REJECTED TAKEOFF</b>
-------------------------

Applicable to: ALL

### GENERAL

The decision to reject the takeoff and the stop action is made by the Captain. It is therefore recommended that the Captain keeps his hand on the thrust levers until the aircraft reaches V1, whether he is Pilot Flying (PF) or Pilot Not Flying (PNF). As soon as he decides to abort, he calls "stop", takes over control of the aircraft and performs the stop actions. It is not possible to list all the factors that could lead to the decision to reject the takeoff. However, in order to help the Captain to make a decision, the ECAM inhibits the warnings that are not essential from 80 kt to 1 500 ft (or 2 min after lift-off, whichever occurs first). Experience has shown that rejected takeoffs can be hazardous even if the performance is correctly calculated, based on flight tests.

This may be due to the following factors:

- Delay in Performing the stopping procedure.
- Damaged tires.
- Brakes worn, brakes not working correctly, or higher than normal initial brakes temperature.
- The brakes not being fully applied.
- A runway friction coefficient lower than assumed in computations.
- An error in gross weight calculation.
- Runway line up not considered.

When the aircraft speed is at or above 100 kt, it may become hazardous to reject a takeoff.

Therefore, when the aircraft speed approaches V1, the Captain should be "Go-minded" if none of the main failures quoted below ("Above 100 kt and below V1") have occurred.

### DECISION MANAGEMENT

#### ■ Below 100 kt:

The decision to reject the takeoff may be taken at the Captain's discretion, depending on the circumstances.

Although we cannot list all the causes, the Captain should seriously consider discontinuing the takeoff, if any ECAM warning/caution is activated.

Note: *The speed of 100 kt is not critical: It was chosen in order to help the Captain make his decision, and to avoid unnecessary stops from high speed.*

*Continued on the following page*

 <b>AIRBUS</b> FOR TRAINING ONLY <b>A318/A319/A320/A321</b> FLIGHT CREW OPERATING MANUAL	<b>PROCEDURES</b> <b>ABNORMAL AND EMERGENCY PROCEDURES</b>  <b>OPERATING TECHNIQUES</b>
---	--

**REJECTED TAKEOFF (Cont'd)**

■ **Above 100 kt and below V1:**

Rejecting the takeoff at these speeds is a more serious matter, particularly on slippery runways. It could lead to a hazardous situation, if the speed is approaching V1. At these speeds the Captain should be "go-minded" and very few situations should lead to the decision to reject the takeoff:

1. Fire warning or severe damage.
2. Sudden loss of engine thrust.
3. Malfunctions or conditions that give unambiguous indications that the aircraft will not fly safely.
4. Any red ECAM warning.
5. Any amber ECAM caution listed below:
  - F/CTL SIDESTICK FAULT
  - ENG FAIL
  - ENG REVERSER FAULT
  - ENG REVERSE UNLOCKED

Exceeding the EGT red line or nose gear vibration should not result in the decision to reject takeoff above 100 kt.

In case of tire failure between V1 minus 20 kt and V1:

Unless debris from the tires has caused serious engine anomalies, it is far better to get airborne, reduce the fuel load, and land with a full runway length available.

The V1 call has precedence over any other call.

■ **Above V1:**

Takeoff must be continued, because it may not be possible to stop the aircraft on the remaining runway.

**PROCEDURE DURING A REJECTED TAKEOFF**

CAPT	F/O
"STOP"..... ANNOUNCE	
Simultaneously:	
THRUST LEVERS..... IDLE	
REVERSE THRUST..... MAX AVAIL	REVERSERS..... CHECK/ANNOUNCE
	DECELERATION..... CHECK/ANNOUNCE
	ANY AUDIO..... CANCEL
<b>Aircraft stopped</b>	
Consider positioning the aircraft to keep any possible fire away from the fuselage.	
REVERSERS..... STOWED	ATC..... NOTIFY
PARKING BRAKE..... ON	EMER EVAC Procedure (QRH)..... LOCATE

*Continued on the following page*



 <b>A318/A319/A320/A321</b> FLIGHT CREW OPERATING MANUAL	<b>PROCEDURES</b> <b>ABNORMAL AND EMERGENCY PROCEDURES</b> <b>OPERATING TECHNIQUES</b>
--	--

**REJECTED TAKEOFF (Cont'd)**

CAPT	F/O
CABIN CREW.....ALERT ECAM ACTIONS.....ORDER The aircraft should remain stationary while the crew evaluates the situation.	ECAM ACTIONS.....PERFORM
<b><u>EVACUATION PHASE:</u></b> *If required: EMER EVAO Procedure.....APPLY For more information on the EMER EVAO procedure, Refer to PRO-ABN-80 EMERGENCY EVACUATION Except if the emergency evacuation procedure is within the ECAM procedure of the failure, the flight crew should apply the non-sensed emergency evacuation procedure on the ECAM or the QRH procedure, as appropriate.	ATO.....NOTIFY Inform ATO of the intention and the required assistance.

**REVERSERS** : Full reverse may be used until coming to a complete stop. But, if there is enough runway available at the end of the deceleration, it is preferable to reduce reverse thrust when passing 70 kt.

- Note:**
1. If the brake response does not seem appropriate for the runway condition, FULL manual braking should be applied and maintained. If **IN DOUBT, TAKE OVER MANUALLY**. Do not attempt to clear the runway, until it is absolutely clear that an evacuation is not necessary and that it is safe to do so.
  2. If the autobrake is unserviceable, the Captain simultaneously reduces thrust and applies maximum pressure on both pedals.  
The aircraft will stop in the minimum distance, only if the brake pedals are maintained fully pressed until the aircraft comes to a stop.
  3. If normal braking is inoperative, immediately apply the Loss of Braking procedure (Refer to PRO-ABN-32 LOSS OF BRAKING)
  4. After a rejected takeoff, if the aircraft comes to a complete stop using autobrake MAX, release brakes prior to taxi by disarming spoilers.

## Appendix 9 MEL Paragraph Related to Propellers

 <b>ATR72-600 MEL/CDL</b>		PAGE: 1-61-2		
		SEQ: 001		
<b>61 PROPELLERS</b>				
1. ITEM	2. RECTIFICATION INTERVAL	3. NUMBER INSTALLED	4. NUMBER REQUIRED FOR DISPATCH	5. REMARKS OR EXCEPTIONS
21-4 <b>PIU And Associated Propeller Speed Selection</b>	C	2	0	(o) May be inoperative provided both CL are set to 100% OVRD. <b>Note:</b> If affected side cannot be identified, both PIU should be considered as inoperative.
<b>OPERATING PROCEDURES</b>				
a) Engine not running – PL on GI – CL on FUEL SO – RH Maintenance Panel, set WOW on FLT position – Advance CL to AUTO – Check PEC FAULT illuminates after 30 seconds – Retard CL to FUEL SO – Check PEC FAULT extinguishes after 30 seconds – Reset PEC to make sure that SGL CH extinguishes – RH Maintenance Panel, set WOW on NORM position b) Confirm SGL CH light illumination and extinction during unfeathering.				
22-1 <b>Autofeather System (and Associated Test)</b>	OD C	2	0	* (o) May be inoperative provided operations are conducted in compliance with AFM
<b>OPERATING PROCEDURES</b>				
– Refer to AFM Supplement 7_02.06: Dispatch with Autofeather system inoperative. – For MTOW and takeoff speeds, refer to the RTOW chart titled "AUTOFEATHER INOP". Note: In case of engine failure after V1, do not reduce PL below 45° of PLA before feathering.				
22-2 <b>ATPCS (and Associated Test)</b>	OD C	1	0	* (o) May be inoperative provided operations are conducted in compliance with the AFM
<b>OPERATING PROCEDURES</b>				
– Refer to AFM Supplement 7_02.10: Dispatch with ATPCS OFF. – For MTOW and takeoff speeds, refer to the RTOW chart titled "ATPCS OFF".				
22-3 <b>ATPCS ARM Light</b>	C	1	0	* May be inoperative provided ATPCS is considered inoperative.
<b>ALL</b>				

 <b>NR 72 A</b>  AFM	<b>SUPPLEMENTS</b>  SUPPLEMENT N° 06	7 - 02.06	
		PAGE : 1	001
		DGAC APPROVED	FEB 01
<p><b><u>DISPATCH WITH AUTOFEATHER SYSTEM INOPERATIVE</u></b></p> <p>Utrim and AFU are considered operative. If not, refer to the connected procedure.</p> <ul style="list-style-type: none"> <li>- Increase V1 limited by VMCG by 5 kt</li> <li>- Increase VR by 2 kt</li> <li>- Increase VMCA by 3 kt, check VR, V2</li> <li>- Increase VMCL by 3 kt</li> <li>- Check effect on TOR, TOD, 2nd segment climb</li> </ul> <p><u>NOTE</u> :In case of engine failure after V1, do not reduce PL below 45° of PLA before feathering.</p>			

 <b>ATR 72 A</b>  AFM	<b>SUPPLEMENTS</b>  SUPPLEMENT N° 10	7-02.10	
		PAGE : 1	001
		DGAC APPROVED	FEB 01
<b><u>DISPATCH WITH ATPCS OFF</u></b>			
<p>AFU is considered operative. If not, refer to the connected procedure.</p> <ul style="list-style-type: none"> <li>- Select ATPCS OFF and BLEED VALVES OFF</li> <li>- Increase V1 limited by VMCG by 5 kt</li> <li>- Increase VR by 2 kt</li> <li>- Increase VMCA by 3 kt. Check VR and V2</li> <li>- Increase VMCL by 3 kt</li> <li>- Check ATPCS inoperative effect on TOR, TOD and 2nd segment</li> <li>- Apply RTO power by pushing both PLs up to the ramp</li> <li>- After take off set both PLs into the notches, then apply CLIMB SEQUENCE</li> <li>- BLEED VALVES ..... ON</li> </ul> <p><b>NOTE</b> :In case of engine failure after V1 do not reduce PL below 45° of PLA before feathering</p>			

Intentionally Left Blank



WARNING - PROPRIETARY RIGHTS & EXPORT CONTROLS NOTICE

This bulletin contains proprietary information of Pratt & Whitney Canada Corp. ("P&WC"), which P&WC provides in confidence and solely for the purposes of supporting engine certification and providing applicable information regarding the proper use, maintenance, inspection, repair, servicing and parts application of P&WC products and services, as directed therein. Neither this bulletin nor any information in it may be disclosed to others, or used for any other purpose, including, without limitation, to design, create, develop, reproduce, manufacture or derive any design, part, product, material, process, modification, configuration change or repair, or obtain FAA or other government approval to do so. Possession and use of this bulletin is also subject to the restrictions set out in P&WC's Technical Data Agreement (a copy of which may be obtained by contacting P&WC Technical Publications). The contents of this bulletin may be subject to export control laws. Unauthorized export or re-export of the bulletin, or parts thereof, is prohibited. By accepting and possessing this bulletin, you agree to be bound by the foregoing terms.

If a Government agency or department intends to disclose any information, written notice should be given to:  
VP - Legal Services, Pratt & Whitney Canada Corp., 1000 Marie-Victorin (01BE5), Longueuil, Quebec J4G 1A1.

Pratt & Whitney Canada Corp.  
1000, Marie-Victorin  
Longueuil, Québec, Canada J4G 1A1  
Tél. 450-677-9411



**Pratt & Whitney Canada**

A United Technologies Company

17 August 2007

P&WC S.B. No. 21742R1

REVISION TRANSMITTAL SHEET  
TURBOPROP ENGINE MODEL PW100

SUBJECT: Pratt & Whitney Canada Service Bulletin No. PW100-72-21742, Rev. No. 1, dated Aug 17/2007 (P&WC S.B. No. 21742R1) AUTOFEATHER UNIT - INSPECTION OF

Replace your existing copy of this service bulletin with the attached revised bulletin. Destroy the superseded copy.

Please retain this Revision Transmittal Sheet with the revised bulletin.

SUMMARY: This revision is issued to:

- add the AFU in the reason;
- to give the date of issue of the CMM latest instructions;
- clarify the Accomplishment Instructions to identify AFUs that are eligible for the inspections, and to give instruction for those that already complied with the intent of this service bulletin.
- move the CMM P/N 73-20-03 from the Publication Affected, Para. 1.K, to the References, Para. 1.J.

EFFECT OF REVISION ON PRIOR ACCOMPLISHMENT:

None.

NOTE: A black bar in the left margin indicates a change in that line of text or figure.

REVISION HISTORY:

Original Issue: Aug 15/2007  
Revision No. 1: Aug 17/2007



# PRATT & WHITNEY CANADA SERVICE BULLETIN

P&WC S.B. No. 21742R1

## TURBOPROP ENGINE AUTOFEATHER UNIT - INSPECTION OF

1. Planning Information

A. Effectivity

PW121A Engines with AFU P/N 30048-0000-04.  
 PW124B Engines with AFU P/N 30048-0000-04, 30048-0000-05, 30048-0000-06,  
 30048-0000-08, 30048-0000-10, 30048-0000-12.  
 PW125B Engines with AFU P/N 30048-0000-01A, 30048-0000-02, 30048-0000-04,  
 30048-0000-07, 30048-0000-09, 30048-0000-11.  
 PW126 / PW126A Engines with AFU P/N 30048-0000-01A, 30048-0000-02,  
 30048-0000-04, 30048-0000-07, 30048-0000-13, 30048-0000-14, 30048-0000-19.  
 PW127 Engines with AFU P/N 30048-0000-12, 30048-0000-16, 30048-0000-18.  
 PW127B Engines with AFU P/N 30048-0000-15, 30048-0000-17.  
 PW127D Engines with AFU P/N 30048-0000-19.  
 PW127E Engines with AFU P/N 30048-0000-18.  
 PW127F Engines with AFU P/N 30048-0000-18.  
 PW127G Engines with AFU P/N 30048-0000-21.  
 PW127H Engines with AFU P/N 30048-0000-18.  
 PW127J Engines with AFU P/N 30048-0000-16, 30048-0000-18

NOTE: The above effectivity list does not identify engines that have been converted from one engine model to another engine model via an engine conversion service bulletin. To clarify the effectivity of converted engines, refer to the PW100 Workscope Planning Guide, P/N 3040879, Converted Engines section.

B. Concurrent Requirements

None.

C. Reason

Aging of the Autofeather Unit (AFU) electrical connectors and interconnect ribbon solder joints can lead to loss of torque signal.

D. Description

The AFU is returned to an authorized accessory shop that can do a one time inspection of the AFU per the latest CMM instructions.

NOTE: For AFUs that were inspected/certified per the Goodrich CMM P/N 30048-0000 Rev. H, latest instructions issued after Feb 23/2007 (Ref. Goodrich TR73-01), the intent of this service bulletin is already incorporated. No further action is required.

P&WC No. 004211  
 P&WC Proprietary Information. Subject to the restrictions on the back of the locator.  
 Aug 15/2007  
 Revision No. 1: Aug 17/2007

© 2007 Pratt & Whitney Canada Corp.  
 PRINTED IN CANADA

**PW100-72-21742**  
 Page 1 of 4

PRATT & WHITNEY CANADA  
**SERVICE BULLETIN**

P&WC S.B. No. 21742R1

TURBOPROP ENGINE  
AUTOFEATHER UNIT - INSPECTION OF

1. Planning Information (Cont'd)

E. Compliance

**For AFU with more than TTSN 12,000 flight hours, or that TTSN of the AFU is unknown:**

CATEGORY 3 - P&WC recommends to do this service bulletin before July 31, 2010.

**For AFU with less than TTSN 12,000 flight hours:**

CATEGORY 3 - P&WC recommends to do this service bulletin before the AFU has accumulated TTSN 12,000 flight hours, or before July 31, 2010, whichever occurs last.

F. Approval

D.A.A. approved

G. Weight and Balance

None.

H. Electrical Load Data

Not changed.

I. Software Accomplishment Summary

Not changed.

J. References

Applicable PW100 Technical Manuals  
P&WC Service Information Letter (SIL) PW100-113  
Goodrich Service Letter 30048-SL-001  
Goodrich CMM P/N 30048-0000 (73-20-03)

K. Publications Affected

Applicable PW100 Technical Manuals  
Deleted

L. Interchangeability and Intermixability of Parts

Not applicable.

P&WC Proprietary Information. Subject to the restrictions on the back of the locator.  
Aug 15/2007  
Revision No. 1: Aug 17/2007

**PW100-72-21742**  
Page 2 of 4

PRATT & WHITNEY CANADA  
**SERVICE BULLETIN**

P&WC S.B. No. 21742R1

TURBOPROP ENGINE  
AUTOFEATHER UNIT - INSPECTION OF

2. Material Information

A. Industry Support Information

Not applicable.

B. Material - Cost and Availability

Not applicable.

C. Manpower

No more man-hours are necessary to include this service bulletin at overhaul.

D. Material Necessary for Each Engine

Not applicable.

E. Reidentified Parts

None.

F. Tooling - Price and Availability

Not applicable.

3. Accomplishment Instructions

A. Make sure the AFU is applicable for the inspection per this service bulletin. For AFUs that were inspected/certified per the Goodrich CMM P/N 30048-0000 Rev. H, latest instructions issued after Feb 23/2007 (Ref. Goodrich TR73-01), the intent of this service bulletin is already incorporated. Go to Paragraph 3.E.

B. Remove the AFU. Refer to the instructions in the applicable maintenance or overhaul manual.

C. Return the AFU to an authorized accessory shop, or the address listed below, that can do the inspection of the AFU per the latest Goodrich CMM P/N 30048-0000 Rev. H, latest instructions issued after Feb 23/2007 (Ref. Goodrich TR73-01).

PRATT & WHITNEY CANADA  
**SERVICE BULLETIN**

P&WC S.B. No. 21742R1

TURBOPROP ENGINE  
AUTOFEATHER UNIT - INSPECTION OF

3. Accomplishment Instructions (Cont'd)

Goodrich Sensors and Integrated Systems  
1256 Trapp Rd.  
Eagan Mn 55121  
USA

Attention: Tami Banks

TEL: 651-681-8800

FAX: 651-681-8991

REF: Goodrich Service Letter 30048-SL-001

- D. Install the serviceable AFU. Refer to the instructions in the applicable maintenance or overhaul manual.
- E. Write accomplishment of P&WC S.B. No. 21742 in the applicable engine module log book.

4. Appendix

Not applicable.

P&WC Proprietary Information. Subject to the restrictions on the back of the locator.  
Aug 15/2007  
Revision No. 1: Aug 17/2007

**PW100-72-21742**  
Page 4 of 4

Intentionally Left Blank

## Appendix 11 CAA AD No.CAA-2015-02-013E Revised



### 緊急適航指令

民航局 AD 編號 CAA-2015-02-013E 修訂

#### 1. 適用之航空產品

本緊急適航指令，適用於 ATR72-212A 之航空器型別。  
註：未執行 ATR 原製造廠 MOD5948 改裝之機型為 ATR72-500，執行 MOD5948 改裝後機型為 ATR72-600。

#### 2. 緣由

近期 ATR72-212A 型機在發動機運作時發生非指令性自動順槳(Uncommanded Auto-Feather)情形，經飛機原製造廠 ATR 初步調查，發生非指令性自動順槳情形前，曾出現自動式起飛動力控制系統(ATPCS)間歇式開啟及關閉情形。ATR 原廠已針對此情況發布 OEB 通告，指出非指令性自動順槳情形，可視為一種發動機失效之現象，並建議相關緊急處理程序，目前本事件肇因仍於調查作業中，惟基於此情況可能造成發動機失效並增加飛航組員操作應變之負擔，本局已發布緊急 AD CAA-2015-02-013E，提供航空器所有人及飛航組員相關緊急處理程序，以確保飛航安全。

上述緊急 AD 發布後，ATR 原廠分別針對 ATR72-500 及 ATR72-600 機型，發布修訂版 OEB 通告，並更正單發動機飛航操作程序所引用之 QRH 章節，因此本局發布本緊急 AD 修訂版，納入 ATR 原廠修訂版 OEB 通告。

#### 3. 改正行動與執行時限

- (1) 航空器所有人應立即將適用之 ATR “OEB Subject: Uncommanded auto-feather - 500”及“OEB Subject: Uncommanded auto-feather - 600”納入 QRH。
- (2) 航空器所有人應對飛航組員實施上述 OEB 相關緊急處理訓練，強化狀況警覺，與發動機失效後之處置及單發動機飛航操作程序。

**緊急適航指令(續頁)**

民航局 AD 編號 CAA-2015-02-013E 修訂

**4. 生效日期**

104 年 2 月 26 日。

**5. 備註：**

本適航指令為預防性作為，將視調查結果及原廠建議，發布後續相關適航指令。



**Emergency Airworthiness Directive  
AD Number CAA-2015-02-013E Correction**

Date: February 25, 2015

Correction: February 26, 2015

**1. APPLICABILITY**

ATR72-212A (Note: For those airplanes which the ATR MOD 5948 are not embodied, the airplane type can be referred to as ATR72-500. For those airplanes which the MOD 5948 are embodied, the airplane type can be referred to as ATR72-600.)

**2. REASON**

Uncommanded auto-feather events were reported on in-service ATR72-212A. The propeller goes in feather while the power plant is still running. According to the preliminary investigation, the intermittent ATPCS arming/disarming sequence during takeoff roll has been observed prior to some uncommanded auto-feather events.

This condition, if not corrected, could result in engine failure and consequent increased flightcrew workload.

To address this potential unsafe condition, ATR has issued Operations Engineering Bulletin (OEB) to provide the emergency procedure to deal with the uncommanded auto-feather situation. In the OEB, ATR also viewed the uncommanded auto-feather situation as an engine failure due to the associated symptoms of TQ (torque), NP (propeller rotation speed) and NH (high pressure spool rotation speed).

An emergency AD CAA-2015-02-013E requiring amendment of the applicable QRH according the ATR OEB has been issued.

Since Emergency AD CAA-2015-02-013E was issued, ATR re-issues the separate OEBs related to ATR72-500 and ATR72-600 accordingly and corrects applicable reference QRH pages.

For reasons described above, this emergency AD correction retains the requirements of emergency AD CAA-2015-02-013E, which is superseded, to require to reference ATR re-issued separate OEBs and amend applicable QRHs.





**Emergency Airworthiness Directive (continued)  
AD Number CAA-2015-02-013E Correction**

**3. ACTIONS AND COMPLIANCE TIME**

Required as indicated, unless accomplished previously:

- (1) Before next flight after the effective date of this emergency AD, amend the applicable QRH by inserting a copy of ATR "OEB Subject: Uncommanded auto-feather - 500" and "OEB Subject: Uncommanded auto-feather - 600", as applicable to airplane type and model.
- (2) Concurrent with the QRH amendment as required by paragraph (1) of this AD, inform and train all flightcrews and, thereafter, operate the airplane accordingly. Besides, operators shall enhance flightcrew's situation awareness and training regarding the disposition of engine failure and single engine operation.

**4. EFFECTIVE DATES**

February 26, 2015

**5. NOTE :**

- (1) This emergency AD is still considered to be an interim action and further AD action may follow.
- (2) Reference Publications:  
ATR "OEB Subject: Uncommanded auto-feather - 500"  
ATR "OEB Subject: Uncommanded auto-feather - 600"
- (3) Enquiries regarding this emergency AD should be referred to the Initial Airworthiness Section, Flight Standards Division, CAA Taiwan. E-mail: [adcaa@mail.caa.gov.tw](mailto:adcaa@mail.caa.gov.tw)

## Appendix 12 ATR OEB on Uncommanded Auto-feather

### OEB Subject: Uncommanded auto-feather - 500

#### 1. Reason for issue.

This OEB is issued to provide operators with operational recommendations about in-service events of uncommanded auto-feather: a situation where a propeller goes in feather while the engine is still running. The associated symptoms are:

- TQ and NP decrease to or close to 0, and
- NH drops to around 73% and remains steady.

This OEB aims also at providing additional information about ATPCS arming during takeoff roll. An intermittent ATPCS arming/disarming sequence during takeoff roll has been observed prior to some uncommanded auto-feather events.

Any loss of engine propeller rotation speed (NP) and/or torque (TQ) should be dealt with as an engine failure.

- At takeoff, the ENG FLAME OUT AT TAKEOFF procedure is applicable.  
Depending on the root cause of the uncommanded auto-feather, the affected engine propeller may unfeather upon PWR MGT selection to MCT. In any case, ATR recommends proceeding with the ENG FLAME OUT AT TAKEOFF procedure until engine is shutdown.
- During any other phase of flight, the analysis of in-service events have shown that the ENG FLAME OUT IN FLIGHT procedure does not apply to uncommanded auto-feather symptoms, because NH never drops below 30%.

#### 2. ATR action.

Investigations are in progress to identify the root cause of the reported events and to define appropriate corrective actions.

#### 3. Procedures.

##### a. Take off normal procedure

At takeoff, the ATPCS must be checked armed and announced. If it is not armed while both power levers are in the notch, or in the case of intermittent arming / disarming of the ATPCS, the takeoff must be rejected.

##### b. Any loss of NP and/or TQ should be dealt with as an engine failure

###### i. During Takeoff

ENG FLAME OUT AT TAKEOFF procedure is applicable.

###### ii. During any other phase of flight

Apply the following procedure:

PL affected side .....FI  
 CL affected side .....FTR THEN FUEL SO  
 LAND ASAP  
 SINGLE ENG OPERATION procedure (2.04).....APPLY

**OEB Subject: Uncommanded auto-feather – 600**

**1. Reason for issue.**

This OEB is issued to provide operators with operational recommendations about in-service events of uncommanded auto-feather: a situation where a propeller goes in feather while the engine is still running. The associated symptoms are:

- TQ and NP decrease to or close to 0, and
- NH drops to around 73% and remains steady.

This OEB aims also at providing additional information about ATPCS arming during takeoff roll. An intermittent ATPCS arming/disarming sequence during takeoff roll has been observed prior to some uncommanded auto-feather events.

Any loss of engine propeller rotation speed (NP) and/or torque (TQ) should be dealt with as an engine failure.

- At takeoff, the ENG FLAME OUT AT TAKEOFF procedure is applicable.  
Depending on the root cause of the uncommanded auto-feather, the affected engine propeller may unfeather upon PWR MGT selection to MCT. In any case, ATR recommends proceeding with the ENG FLAME OUT AT TAKEOFF procedure until engine is shutdown.
- During any other phase of flight, the analysis of in-service events have shown that the ENG FLAME OUT IN FLIGHT procedure does not apply to uncommanded auto-feather symptoms, because NH never drops below 30%.

**2. ATR action.**

Investigations are in progress to identify the root cause of the reported events and to define appropriate corrective actions.

**3. Procedures.**

**a. Take off normal procedure**

At takeoff, the ATPCS must be checked armed and announced. If it is not armed while both power levers are in the notch, or in the case of intermittent arming / disarming of the ATPCS, the takeoff must be rejected.

**b. Any loss of NP and/or TQ should be dealt with as an engine failure**

**i. During Takeoff**

ENG FLAME OUT AT TAKEOFF procedure is applicable.

**ii. During any other phase of flight**

Apply the following procedure:

PL affected side .....FI  
 CL affected side .....FTR THEN FUEL SO  
 LAND ASAP  
 SINGLE ENG OPERATION procedure (2.05).....APPLY

## Appendix 13 P&WC Service Bulletin No. 21880R1

### PRATT & WHITNEY CANADA SERVICE BULLETIN

P&WC S.B. No. 21880R1

## BULLETIN INDEX LOCATOR 72-01-10

TURBOPROP ENGINE  
AUTOFEATHER CONTROL UNIT - REPLACEMENT/MODIFICATION OF  
MODEL APPLICATION

PW127, PW127E, PW127F, PW127G, PW127H, PW127J, PW127M, PW127N

Commercial Support Program No: 1008330

Compliance: CATEGORY 3, 5

**Summary:** There have been reports from the field of torque fluctuations or loss of torque indications. The autofeather control J2 connector is a flex-tape design that is connected to the circuit card by solder. Replace the autofeather control with one that has a rigid-flex type J2 connector.

Oct 19/2015  
Revision No. 1: Oct 30/2015

**PW100-72-21880**  
Cover Sheet

24-Hour Global Service	USA & CANADA..... 1-800-268-8000	Other..... 1-450-647-8000
<b>CFIRST CENTRE</b>	International..... (1AC*)+8000-268-8000	Fax..... 1-450-647-2888
Toll free where available (SIL GEN-027)	* International Access Code	Web Site..... <a href="http://www.pwc.ca">www.pwc.ca</a>

**WARNING - PROPRIETARY RIGHTS & EXPORT CONTROLS NOTICE**

This bulletin contains proprietary information of Pratt & Whitney Canada Corp. ("P&WC"), which P&WC provides in confidence and solely for the purposes of supporting engine certification and providing applicable information regarding the proper use, maintenance, inspection, repair, servicing and parts application of P&WC products and services, as directed therein. Neither this bulletin nor any information in it may be disclosed to others, or used for any other purpose including, without limitation, to design, create, develop, reproduce, manufacture or derive any design, part, product, material, process, modification, configuration change or repair, or obtain FAA or other government approval to do so. Possession and use of this bulletin is also subject to the restrictions set out in P&WC's Technical Data Agreement (a copy of which may be obtained by contacting P&WC Technical Publications). The contents of this bulletin may be subject to export control laws. Unauthorized export or re-export of the bulletin, or parts thereof, is prohibited. By accepting and possessing this bulletin, you agree to be bound by the foregoing terms.

If a Government agency or department intends to disclose any information, written notice should be given to:  
 VP - Legal Services, Pratt & Whitney Canada Corp., 1000 Marie-Victorin (Q1BE5), Longueuil, Quebec J4G 1A1.

Export Control Classification		
*Data is subject to the jurisdiction of the Export and Import Controls Bureau of the Department of Foreign Affairs and International Trade of Canada, Department of Commerce of the United States and/or Department of State of the United States.  ** Data is not subject to the jurisdiction of the Department of Commerce of the United States or Department of State of the United States but would become subject if exposed to any US involvement.	<b>Regulation</b>	<b>Classification Number</b>
	Canadian ECL(s)*	
	ECCN(s)*	
	P-ECCN(s)**	9E991
	USML (ITAR)*	
	P-USML**	

Pratt & Whitney Canada Corp.  
1000, Marie-Victorin  
Longueuil, Québec, Canada J4G 1A1  
Tel. 450-677-9411



**Pratt & Whitney Canada**  
A United Technologies Company

30 October 2015

P&WC S.B. No. 21880R1

REVISION TRANSMITTAL SHEET  
TURBOPROP ENGINE MODEL PW100

SUBJECT: Pratt & Whitney Canada Service Bulletin No. PW100-72-21880, Rev. No. 1, dated Oct 30/2015 (P&WC S.B. No. 21880R1) AUTOFEATHER CONTROL UNIT - REPLACEMENT/MODIFICATION OF

Replace your existing copy of this service bulletin with the attached revised bulletin. Destroy the superseded copy.

Please retain this Revision Transmittal Sheet with the revised bulletin.

SUMMARY: This revision is issued to:

- Added PW127G engine model to service bulletin.
- Added additional CC 03 for Table 2 Appendix.
- Added CSPN No. in Para. 2.A. Industry Support Information.
- Added PW127G parts progression in Appendix
- Added Table 2 in Appendix for Auto Feather units P/N 30048-0000-21.

EFFECT OF REVISION ON PRIOR ACCOMPLISHMENT:

None.

NOTE: A black bar in the left margin indicates a change in that line of text or figure.

REVISION HISTORY:

Original Issue: Oct 19/2015  
Revision No. 1: Oct 30/2015

# PRATT & WHITNEY CANADA SERVICE BULLETIN

P&WC S.B. No. 21880R1

## TURBOPROP ENGINE AUTOFEATHER CONTROL UNIT - REPLACEMENT/MODIFICATION OF

1. Planning Information

A. Effectivity

PW127 Engines which are before and include Serial No. PCE-127217 and which are before and include Serial No. PCE-AK0013  
 PW127E Engines which are before and include Serial No. PCE-127211 and which are before and include Serial No. PCE-AM0117  
 PW127F Engines which are before and include Serial No. PCE-AV0120  
 PW127E / PW127F Engines which are before and include Serial No. PCE-EB0368  
 PW127G Engines which are before and include Serial No. PCE-AX0372  
 PW127H Engines which are before and include Serial No. PCE-AY0019  
 PW127J Engines which are before and include Serial No. PCE-EA0264  
 PW127M Engines which are before and include Serial No. PCE-ED1226  
 PW127N Engines

NOTE: The above effectivity list does not identify engines that have been converted from one engine model to another engine model via an engine conversion service bulletin. To clarify the effectivity of converted engines, refer to the PW100 Workscope Planning Guide, P/N 3040879, Converted Engines section.

B. Concurrent Requirements

P&WC recommends to incorporate SB No. 21822 prior to, or in conjunction with this service bulletin.

C. Reason

(1) Problem

There have been reports from the field of torque fluctuations or loss of torque indications.

(2) Cause

The autofeather control J2 connector is a flex-tape design that is connected to the circuit card by solder.

(3) Solution

Replace the autofeather control with one that has a rigid-flex type J2 connector.

D. Description

Replace the autofeather control with a new or modified one.

E. Compliance

**For Autofeather Control Part Numbers and Serial Numbers listed in Table 1 Appendix**

CATEGORY 3 - Replace autofeather controls before December 31st 2015

P&WC No. E9485B, E9485D

Oct 19/2015

Revision No. 1: Oct 30/2015

P&WC Producting Information. Subject to the restrictions on the back of the label.  
 The export control classification with respect to this document is contained on the back of the label.  
 © 2015 Pratt & Whitney Canada Corp.  
 PRINTED IN CANADA

**PW100-72-21880**

Page 1 of 9

**PRATT & WHITNEY CANADA**  
**SERVICE BULLETIN**

P&amp;WC S.B. No. 21880R1

TURBOPROP ENGINE  
AUTOFEATHER CONTROL UNIT - REPLACEMENT/MODIFICATION OF

## 1. Planning Information (Cont'd)

**For PW127G Autofeather Control Part Numbers and Serial Numbers listed in Table 2 Appendix**

CATEGORY 3 - Replace autofeather controls before December 31st 2015

**For all other Autofeather Controls**

CATEGORY 5 - P&WC recommends to do this service bulletin when the autofeather control is removed from the engine or when engine is removed from the aircraft.  
 Do all spare subassemblies.

## F. Approval

D.O.T./D.A.A. approved.

## G. Manpower

Once you have access to the part, an estimate of 1.00 man-hours is required to include this service bulletin at maintenance.

H. Weight and Balance

None.

I. Electrical Load Data

Not changed.

J. Software Accomplishment Summary

Not changed.

K. References

Illustrated Parts Catalog P/N 3037334 (PW124B/127/127E/127F/127M/127N)  
 Illustrated Parts Catalog P/N 3044824 (PW127G)  
 Illustrated Parts Catalog P/N 3045544 (PW127H)  
 Illustrated Parts Catalog P/N 3043394 (PW127J)  
 Maintenance Manual P/N 3037332 (PW124B/127/127E/127F/127M)  
 Maintenance Manual P/N 3044822 (PW127G)  
 Maintenance Manual P/N 3045542 (PW127H)  
 Maintenance Manual P/N 3043392 (PW127J)  
 SB21822  
 UTAS Service Bulletin No. 30048-73-13

Oct 19/2015  
 Revision No. 1: Oct 30/2015

P&WC Proprietary Information. Subject to the restrictions on the back of the cover.  
 The export control classification with respect to this document is contained on the back of the cover.

**PW100-72-21880**  
 Page 2 of 9



# PRATT & WHITNEY CANADA SERVICE BULLETIN

P&WC S.B. No. 21880R1

## TURBOPROP ENGINE AUTOFEATHER CONTROL UNIT - REPLACEMENT/MODIFICATION OF

1. Planning Information (Cont'd)

L. Publications Affected

Illustrated Parts Catalog P/N 3037334 (PW124B/127/127E/127F/127M/127N)  
 Illustrated Parts Catalog P/N 3044824 (PW127G)  
 Illustrated Parts Catalog P/N 3045544 (PW127H)  
 Illustrated Parts Catalog P/N 3043394 (PW127J)  
 CMM P/N 73-20-03

M. Interchangeability and Intermixability of Parts

Interchangeability - Refer to Para. 2.C.

Intermixability - Not changed.

2. Material Information

A. Industry Support Information

Refer to Customer Support Program Notification No.: 1008330

B. Material - Cost and Availability

You can get the procurable parts listed in Para. 2.C. from any Pratt & Whitney Canada Parts Distribution Center.

The estimated total cost of new parts needed to replace old parts is \$Quote (US, 2015).

The new parts are scheduled to be available October 31/2015.

C. Material Necessary for Each Engine

The quantity of materials listed in this section is on a per Engine basis.

New P/N	Keyword	Old P/N	Qty	Est. Unit List Price (\$US, 2015)	Instructions Disposition
<b>For PW127, PW127E, PW127F, PW127H, PW127J, PW127M, PW127N Engines:</b>					
	Autofeather Control Supplier (60678) P&WC P/N 3078166-01	30048-0000-28	1		(A)(B)
30048-0000-48	Autofeather Control Supplier (60678) P&WC P/N 3126924-01		1	Quote	(A)

Oct 19/2015  
 Revision No. 1: Oct 30/2015

P&WC Proprietary Information. Subject to the restrictions on the back of the header.  
 The export control classification with respect to this document is controlled on the back of the header.

**PW100-72-21880**  
 Page 3 of 9

**PRATT & WHITNEY CANADA**  
**SERVICE BULLETIN**

P&amp;WC S.B. No. 21880R1

TURBOPROP ENGINE  
AUTOFEATHER CONTROL UNIT - REPLACEMENT/MODIFICATION OF

New P/N	Keyword	Old P/N	Qty	Est. Unit List Price (\$US, 2015)	Instructions Disposition
<b>For PW127G Engines:</b>					
	Autofeather Control Supplier (60678) P&WC P/N 3118091-02	30048-0000-21	1		(A)(B)
30048-0000-41	Autofeather Control Supplier (60678) P&WC P/N 3126934-01		1	Quote	(A)

(A) TWO WAY INTERCHANGEABLE - (ATA 200 Explanation Code 02):  
The old or the new part can replace the old or the new part.

(B) Returned the old part(s) to P&WC Component Solutions for Rework:

Pratt & Whitney Component Solutions Inc.  
4905 Starha Drive  
Muskegon MI 49441  
USA

Attention: Sales Department

TEL: 1 (800) 872-1792 or 1 (231) 799-6650

FAX: 1 (231) 799-8732

REF: P&WC S.B. 21880

EMAIL: gp.pwc.spaessupport@pwc.ca

D. Reidentified Parts

None.

E. Tooling - Price and Availability

Not applicable.

3. Accomplishment Instructions

A. Remove the parts listed under the Old P/N column in Para. 2.C., Material Information. Refer to the instructions in the applicable maintenance manual section below:

- Ref. MM, Chapter 72-01-10 ELECTRICAL SYSTEM - REMOVAL/INSTALLATION

B. Send autofeather controls for modification to P&WC Component Solutions (Ref. Para.2.C).

Oct 19/2015

Revision No. 1: Oct 30/2015

P&WC Proprietary information. Subject to the restrictions on the back of this cover.  
The export control classification with respect to this document is maintained to the back of the cover.

**PW100-72-21880**

Page 4 of 9

## PRATT & WHITNEY CANADA SERVICE BULLETIN

P&WC S.B. No. 21880R1

### TURBOPROP ENGINE AUTOFEATHER CONTROL UNIT - REPLACEMENT/MODIFICATION OF

#### 3. Accomplishment Instructions (Cont'd)

- C. Install new or modified autofeather control P/N 3126924-01 (P/N 30048-0000-48) or P/N 3126934-01 (P/N 30048-0000-41) listed under the New P/N column in Para. 2.C., Material Information. Refer to the instructions in the applicable maintenance manual section below:

- Ref. MM, Chapter 72-01-10 ELECTRICAL SYSTEM - REMOVAL/INSTALLATION

- D. Write accomplishment of P&WC S.B. No. 21880 in the applicable engine module log book.

#### 4. Appendix

- A. Refer to Figure 1 for parts progression of the autofeather control.
- B. Refer to Table 1 and 2 for the list of Autofeather control serial numbers.

Oct 19/2015  
Revision No. 1: Oct 30/2015

P&WC Proprietary Information. Subject to the restrictions on the basis of the license.  
The export control classification with respect to this document is contained on the back of the cover.

**PW100-72-21880**  
Page 5 of 9

# PRATT & WHITNEY CANADA SERVICE BULLETIN

P&WC S.B. No. 21880R1

TURBOPROP ENGINE  
AUTOFEATHER CONTROL UNIT - REPLACEMENT/MODIFICATION OF

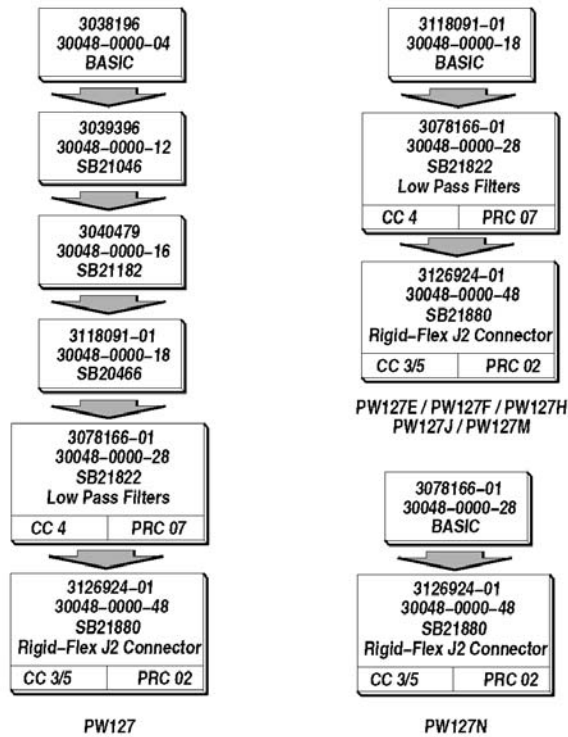

C239851

Progression of the Autfeather Control  
Figure 1 (Sheet 1 of 2)

Oct 19/2015  
Revision No. 1: Oct 30/2015

P&WC Proprietary Information. Subject to the restrictions on the back of the locator.  
The export control classification with respect to this document is contained on the back of the locator.

PW100-72-21880  
Page 6 of 9

# PRATT & WHITNEY CANADA SERVICE BULLETIN

P&WC S.B. No. 21880R1

TURBOPROP ENGINE  
AUTOFEATHER CONTROL UNIT - REPLACEMENT/MODIFICATION OF

3118091-02 30048-0000-21 BASIC
--------------------------------------

3126934-01 30048-0000-41 SB21880 Rigid-Flex J2 Connector	
CC 3/5	PRC 02

PW127G

C240134

Progression of the Autofeather Control  
Figure 1 (Sheet 2)

Oct 19/2015  
Revision No. 1: Oct 30/2015

P&WC Proprietary Information. Subject to the restrictions on the back of the locator.  
The export control classification with respect to this document is contained on the back of the locator.

PW100-72-21880  
Page 7 of 9

**PRATT & WHITNEY CANADA**  
**SERVICE BULLETIN**

P&amp;WC S.B. No. 21880R1

TURBOPROP ENGINE  
AUTOFEATHER CONTROL UNIT - REPLACEMENT/MODIFICATION OF

## 4. Appendix (Cont'd)

TABLE 1. Autofeather Control P/N 30048-0000-18 (Pre-SB21822) and P/N 30048-0000-28

AFU Serial Numbers					
RT0678	RT0738	RT0936	RT1013	RT1822	RT1830
RT1836	RT1837	RT1843	RT1844	RT1848	RT1849
RT1850	RT1857	RT1858	RT1863	RT1864	RT1865
RT1889	RT1893	RT1930	RT1934	RT1935	RT1948
RT1949	RT1971	RT1972	RT1975	RT1976	RT1977
RT1978	RT1981	RT1982	RT1983	RT1984	RT1988
RT1989	RT1999	RT2000	RT2001	RT2007	RT2012
RT2024	RT2025	RT2026	RT2027	RT2028	RT2029
RT2030	RT2031	RT2033	RT2035	RT2043	RT2044
RT2045	RT2052	RT2053	RT2055	RT2057	RT2060
RT2061	RT2064	RT2075	RT2076	RT2077	RT2078
RT2079	RT2091	RT2092	RT2093	RT2103	RT2105
RT2113	RT2114	RT2137	RT2138	RT2140	RT2154
RT2155	RT2156	RT2157	RT2158	RT2159	RT2160
RT2161	RT2162	RT2163	RT2164	RT2165	RT2166
RT2168	RT2173	RT2175	RT2178	RT2180	RT2181
RT2182	RT2183	RT2184	RT2186	RT2188	RT2189
RT2196	RT2197	RT2198	RT2199	RT2201	RT2206
RT2207	RT2210	RT2211	RT2212	RT2252	RT2255
RT2257	RT2260	RT2261	RT2285	RT2286	RT2287
RT2290	RT2291	RT2335	RT2343	RT2347	RT2348
RT2349	RT2352	RT2353	RT2354	RT2355	RT2360
RT2361	RT2362				

Oct 19/2015  
Revision No. 1: Oct 30/2015

P&WC Proprietary information. Subject to the restrictions on the back of the cover.  
The report number classification with respect to this document is numbered on the back of the cover.

**PW100-72-21880**  
Page 8 of 9

# PRATT & WHITNEY CANADA SERVICE BULLETIN

P&WC S.B. No. 21880R1

TURBOPROP ENGINE  
AUTOFEATHER CONTROL UNIT - REPLACEMENT/MODIFICATION OF

4. Appendix (Cont'd)

TABLE 2. Autofeather Control P/N 30048-0000-21

AFU Serial Numbers					
RT0773	RT1594	RT1942	RT1943	RT1944	RT1953
RT1954	RT2037	RT2038	RT2039	RT2040	RT2041
RT2042	RT2110	RT2111	RT2112	RT2147	RT2148
RT2149	RT2150	RT2151	RT2216		

Oct 19/2015  
Revision No. 1: Oct 30/2015

P&WC Proprietary Information. Subject to the restrictions on the back of the Reader.  
The export control classification with respect to this document is contained on the back of the Reader.

**PW100-72-21880**  
Page 9 of 9

## Appendix 14 Analysis of Autopilot Disengagement with FDR Data

According to the document provided by ATR, the manual or automatic disengagement of the autopilot (AP) and yaw damper (YD) can be triggered by the following actions or conditions:

- **Manual disengagement:**

*M1. An action on one AP quick release control pushbutton located on the horn of both control wheels. This action only disengages the AP; the YD remains active.*

*M2. A second action on the AP pushbutton on FGPC. This action only disengages the AP; the YD remains active.*

*M3. An action on the YD pushbutton on FGCP. This action disengages the YD and consequently also disengages the AP.*

*M4. An action on one GA pushbutton (located on the power levers). This action disengages the AP, the YD remains active. The FD modes become the GO AROUND and HDG HOLD modes. The arming phase of the altitude acquisition mode is kept.*

*M5. An action on standby or normal (CAP or F/O) pitch trim command. This action only disengages the AP, the YD remains active.*

*M6. A force of 30 daN applied on the rudder pedals. This action disengages the YD and consequently also disengages the AP.*

*M7. A force of 10 daN applied on the control column (up or down). This action only disengages the AP, the YD remains active.*

- **Automatic disengagement:**

*A1. AP is automatically disengaged in the case of stick shaker activation.*

*A2. AP is automatically disengaged if one of the following conditions is triggered:*

*A2.1 Monitoring of AP inner loops inputs (including ADC and AHRS mismatch detection)*



*A2.2 Monitoring of AP inner loops commands*

*A2.3 Monitoring of AP actuators*

*A2.4 Power on safety test (post) detecting fault*

*Any of these conditions disengage the AP; the YD remains active*

*A3. AP and YD are both automatically disengaged of one of the YD engagement logics lost.*

The FDR parameters evidenced (see graph below):

- 2 Auto Pilot disconnections

AP Disc n°1

AP Disc n°2

- 3 Yaw Damper disconnections

YD Disc n°1

YD Disc n°2

YD Disc n°3

#### **AP Disc n°1 : Manual disconnection**

No FDR parameter allows stating directly if the first autopilot disconnection was manual or automatic. However according to the above disengagement logics the FDR parameters allow to confirm if some of the logics might have been triggered.

According to the FDR readout document (ATR service letter no. ATR72-31-6010, V4), the recorded parameters show that:

- "FD Alert" (CAC1 and CAC2) record 1 = FD MODE CHG, 2 = ATT INVALID, 3 = ADC INVALID, 4 = HDG INVALID, 5 = NAV INVALID, 6 = Reserved (CHECK T/O SPD), 7 = CHECK NAV SRC, 8 = ALT OFF, 9 = STEEP APP.
- "AFCS FMA Messages" (CAC1 and CAC2) record 1 = AP/YD DISENG, 2 = AP DISENG, 3 = YD DISENG, 4 = CAT2 INVALID, 5 = CAT3 INVALID, 6 = AP/YD

INVALID, 7 = AP INVALID, 8 = CHECK SPD HLD, 9 = AP INHIB, 10 = YD INHIB, 11 = SPD HLD INHIB

Reviewing of the FDR data at the time 1052:40 when the autopilot was disengaged, the recorded data indicated that:

- AP disengaged, YD remained active;
- no sticker shaker activation;
- no ADC INVALID, no ADC FAIL records;
- no ATT INVALID, no HDG INVALID and no AHRS FAIL records;
- no AP INHIBIT and no AP INVALID; and
- the autopilot was reengaged at 1053:48 and stayed engaged for 8 seconds.

As described in the FCOM 1.04.10, FMA show message of "AP/YD INVALID" or "AP INVALID" when an AFCS internal failure inhibits AP/YD engagement. FMA show message "AP INHIBIT" or "YD INHIBIT" when AP or YD engagement is attempted and an AFCS external failure or conditions inhibits AP engagement. The FDR data indicated there was no "AP INVALID" and "AP INHIBIT" at the time around 1052:40 when AP disengaged.

Regarding the automatic disengagement: It is observed that none of the automatic logics have been triggered:

- The autopilot was not automatically disengaged by the activation of stick pusher. ~~A1~~
- Only the AP was disengaged, the YD remained active: ~~A3~~
- There was no ADC or AHRS failure/invalid record. The autopilot was not automatically disengaged by monitoring the AP inner loops inputs. ~~A2.1~~
- There was no AP INHIBIT record. These disconnections would have led to the inhibition of the autopilot and would have not allowed the autopilot to reengage the second time. The autopilot was not automatically disengaged by monitoring the AP inner loops commands.

### A2.2

- There was no AP INVALID record. These disconnections are due to discrepancy between the command and the actuator actual position. Those situations can be faced for example while encountering a severe turbulence. In those situations, due to the accelerations encountered the flight control surfaces can move to a position which was not commanded by the AFCS. The aircraft would have also encountered large accelerations as well as flight control surfaces movements with no efforts on the control wheel; the GE235 recorded data did not evidence any of those situations. The autopilot was not automatically disengaged by monitoring the AP actuators. A2.3
- There is no AFCS POST failure since the AP was properly engaged at take-off: A2.4

Regarding the manual disengagement: it is observed that only the conditions M1 or M2 could be fulfilled:

- Only the AP was disengaged, the YD remained active: M3, M6
- There is no system behavior associated with the GA mode activation: M4
- There is no behavior associated with the pitch trim command: M5
- There is no force recorded on the control wheel: M7

As a conclusion AP Disc n°1 can only be a manual disconnection triggered by:

- M1 AP quick release control pushbutton on the control wheels; or by
- M2 A second action on the AP pushbutton on FGPC

### YD Disc n°1: Manual disconnection

According to FDR parameter, RUDPF, an effort of more than 30daN was applied on the rudder pedals at the time of the first yaw damper disconnection. YD Disc n°1 was manual.

**AP Disc n°2: Automatic disconnection**

According to FDR parameters, the second autopilot disconnection is concomitant with a stick shaker activation. AP Disc n°2 was automatic.

**YD Disc n°2: Manual disconnection**

According to FDR parameter, RUDPF, an effort of more than 30daN was applied on the rudder pedals at the time of the second yaw damper disconnection. YD Disc n°2 was manual.

**YD Disc n°3: Manual disconnection**

According to FDR parameter, RUDPF, an effort of more than 30daN was applied on the rudder pedals at the time of the third yaw damper disconnection. YD Disc n°3 was manual.

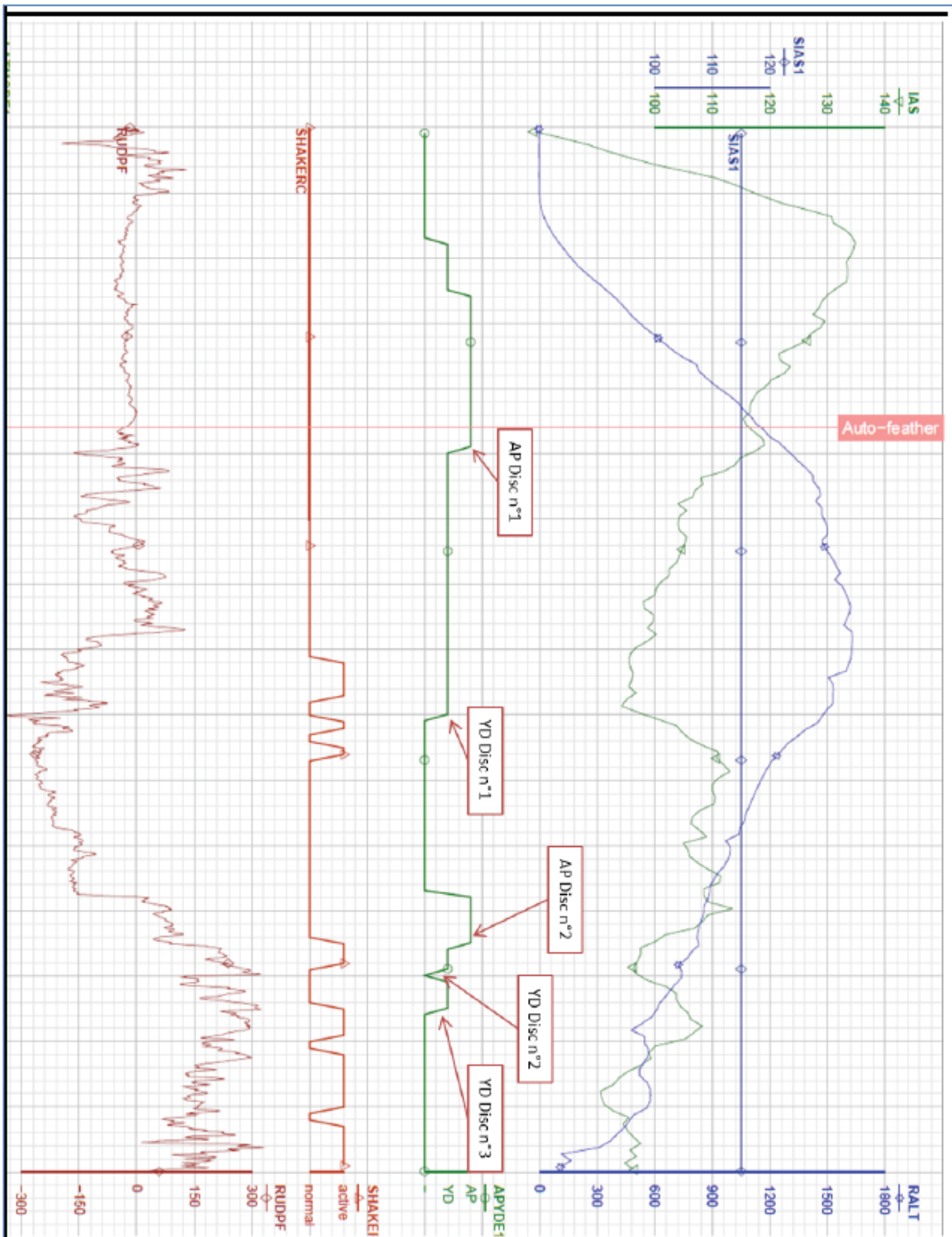

## **Appendix 15 Comments on ASC's Draft Final Report**

Appendix 15-1 Comments on ASC's Final Draft Report from BEA



Appendix 15-2 Comments on ASC's Final Draft Report from TSB

Appendix 15-3 Comments on ASC's Final Draft Report from NTSB

Appendix 15-4 Comments on ASC's Final Draft Report from Civil Aeronautics  
Administration

Appendix 15-5 Comments on ASC's Final Draft Report from TransAsia Airways

## Appendix 15-1 Comments on ASC's Draft Final Report from BEA

 République Française Ministère de l'Écologie, du Développement durable et de l'Énergie	Le Bourget, 20 June 2016
 Bureau d'Enquêtes et d'Analyses pour la sécurité de l'aviation civile	Aviation Safety Council 11F, N°200, Sec 3, Bexing Rd, Xindian District New Taipei City 231 Taiwan (ROC)
N°001880 /BEA/I	
<p><u>Subject:</u> Comments on Final Report related to the accident that occurred to ATR72 registered B-22816 operated by Transasia Airways</p> <p><u>Yrref:</u> ASC-AOR-16-06-001</p> <p><u>Copy:</u> ATR-EASA</p>	
Dir Sir,	
<p>Thank you for giving us the opportunity to review and comment the final report on the aforementioned accident.</p> <p>I would like to congratulate the ASC on conducting a very thorough investigation that resulted in a comprehensive and excellent report. The report gives an accurate description of the circumstances leading to the event and is fully in line with the BEA's understanding.</p>	
<p>I have reviewed the version of the draft final report provided on 3<sup>rd</sup> June 2016, with my technical advisors and have no comment.</p>	
Best regards,	
Senior Safety Investigator Yann Torres French accredited representative	
	
Aéroport du Bourget Zone Sud – Bâtiment 153 10 rue de Paris 93352 Le Bourget Cedex France Tél. : +33 1 49 92 72 00 Fax : +33 1 49 92 72 03 <a href="http://www.bea.aero">www.bea.aero</a>	

## Appendix 15-2 Comments on ASC's Draft Final

**TransAsia GE235 Draft Report Comments**

寄件者：Chapman, Earl <earl.chapman@tsb-bst.gc.ca> ;  
 收件者：wang <wang@asc.gov.tw> ; wang <wang@asc.gov.tw> ;  
 副本：A15F0015 <A15F0015@bst-tsb.gc.ca> ;  
 時間：Wed, 6 Apr 2016 15:23:21 +0000  
 附件：2 個檔案 (A15F0015 - TC Representation.pdf [78.5 KB] , ASC - Final Draft ...irways B-22816.pdf [338.1 KB] )

---

Hello Thomas,

I have just returned to the office from another accident investigation. I received the final comments from Transport Canada on March 31 while I was away, so I am only now able to compile them with the comments from P&WC.

Regardless, please find attached, the comments from both P&WC and Transport Canada for whatever action you deem appropriate. A formal State Comments Letter will follow.

Best regards,

Earl Chapman

Senior Technical Analyst / Systems and Engineering Sciences  
 Transportation Safety Board of Canada / Government of Canada  
[earl.chapman@tsb-bst.gc.ca](mailto:earl.chapman@tsb-bst.gc.ca) / Tel: 613-990-9535 / TTY: 819-953-9535

Analyste technique principal / Systèmes et sciences de l'ingénierie  
 Bureau de la sécurité des transports du Canada / Gouvernement du Canada  
[earl.chapman@bst-tsb.gc.ca](mailto:earl.chapman@bst-tsb.gc.ca) / Tél.: 613-990-9535 / ATS: 819-953-9535



## Appendix 15-3 Comments on ASC's Draft Final Report from NTSB

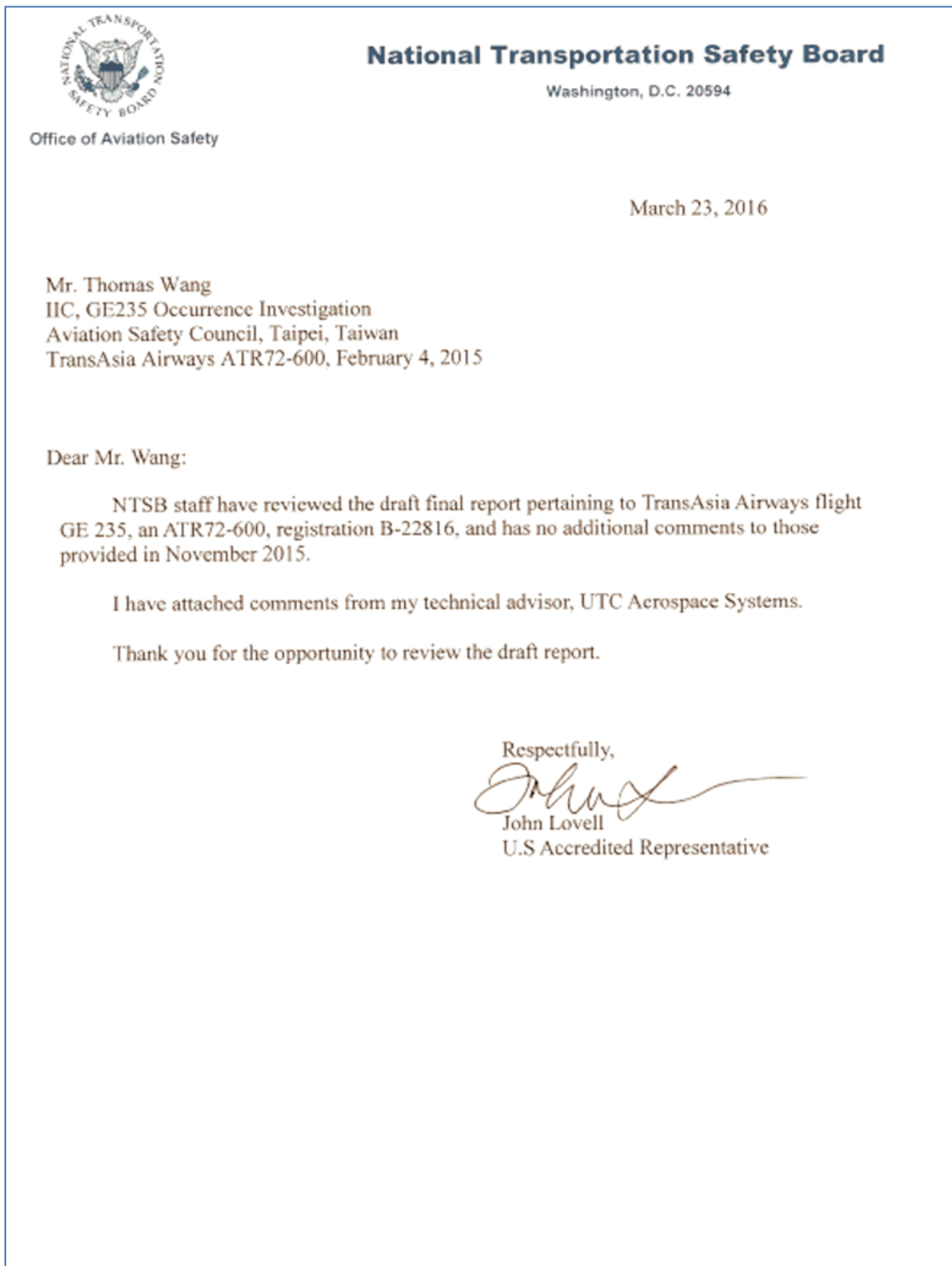

## **Appendix 15-4 Comments on ASC's Draft Final Report from Civil Aeronautics Administration**

In light of the Guidelines for Investigation of Human Factors in Accidents or Incidents published by ISASI (International Society of Air Safety Investigators), CAA adopts the concept that “human error” is the starting point of the investigation, not a stopping point, and would like to make comments on the occurrence investigation report of GE235, to help to produce a report not to apportion blame or liability. Furthermore, design of system hardware can contribute, through design-induced errors, to unsafe acts; SHELL model should be applied in evaluating the liveware-hardware interface; normal patterns of human behavior should also be taken into account. The summary of our comment is as follows:

1. The causes of the continuously intermittent failures of the auto feather unit (AFU) during ATR takeoff rolling were related to manufacture quality, which led to the uncommand autofeather after takeoff. Engine manufacturer had started to redesign a new type AFU and expected to complete the design on 2017. The occurrence investigation report does not require the ATR manufacturer to actively provide solutions.
2. Before the occurrence of GE235, ATR had not announced officially about the procedures and phenomenon regarding the uncommand autofeather, and had not reminded the airlines to react or required additional training to such matters. Furthermore, current simulator in use could not be able to provide such training for the flight crew to effectively identify the uncommand autofeather.
3. According to the EASA certification specifications for such ATR aircraft type, it allows about two seconds buffer to initiate autofeather of engine failure procedures. The engine torque parameters recorded by the FDR during this critical two seconds were contrary to the ones displayed in a normal engine failure. If analyzing such engine failure caused by the wiring anomaly, it might

increase the possibility to clarify what the flight crew can see and feel in the cockpit, and eventually CM1 mistakenly shut down the engine number 1. The occurrence investigation report should also conduct experiments on different groups of type-rated pilots to evaluate the Human Performance under such uncommand autofeather condition.

4. By emulating the occurrence flight under the same condition in the simulator, the autopilot was disconnected by itself, not by the flight crew. And according to the aforementioned ATPCS anomaly and the statements from same type-rated pilots, the flight crew might not re-engage the autopilot.
5. After CM1 mistakenly shut down the engine number 1, the flight crew could not have known the possible power restoration of engine number 2, the flight director reverted to basic mode and the FMA displayed PITCH HOLD guidance, which was contrary to the stall recovery, causing the confusion indication to the flight crew while aircraft was under an approach-to-stall condition. This is not addressed in the occurrence investigation report.
6. During the uncommand autofeather of engine number 2, the flight condition recorded by FDR implies a workload beyond the flight crew could handle, which might be one of the factors eventually led to CM1 mistakenly shut down the engine number 1. CAA suggests a human performance issue other than concluding such human error induced by insufficient training.
7. The flight crew was not provided sufficient information regarding the uncommand autofeather. The simulator could not effectively simulate the engine failure induced by wiring anomaly. Design of system hardware can contribute, through design-induced errors, to unsafe acts. Such occurrence is a typical case caused by chains of error.

Based on the aforementioned facts, CAA would like to make detailed comment on the occurrence investigation report of GE235 as follows. And CAA would also like to express our sincere active participation in the investigation, and present our oversight

action plan for safety improvement after GE 235 accident, including Short-Term, Mid-Term and Long-Term safety improvement initiatives (Supervised by MOTC).

Page/Chapter/ Paragraph/Line	Draft Report Content	Suggested Revision	Reason(s)
//2/1	The accident was the result of many contributing factors which culminated in a stall-induced loss of control. During the initial climb after takeoff, an intermittent discontinuity in engine number 2's auto feather unit (AFU) may have caused the automatic takeoff power control system (ATPCS) sequence which resulted in the uncommanded autofeather of engine number 2 propellers. Following the uncommanded autofeather of engine number 2 propellers, the flight crew did not perform the documented abnormal and emergency procedures to identify the failure and implement the required corrective actions. This led the pilot flying (PF) to retard power of the operative engine number 1 and shut down it ultimately. The loss of thrust during the initial climb and inappropriate flight control inputs by the PF	The accident was the result of many contributing factors which culminated in a stall-induced loss of control. During the initial climb after takeoff, an intermittent discontinuity in engine number 2's auto feather unit (AFU) may have caused the automatic takeoff power control system (ATPCS) sequence which resulted in the uncommanded autofeather of engine number 2 propellers. <b>During the initiation of the first Master Warning, the FDR recorded engine instrument parameters, especially the Torque one, apparently different from the displayed torque values in simulator trainings received by the flight crew, and from parameters of the actual engine failure. Particularly before the autofeather of engine number 2, the recorded Torque values were displayed was opposite to the ones displayed in normal UPTRIM of the</b>	1. Before the occurrence of GE235, ATR had not announced officially about the procedures and phenomenon regarding the uncommand autofeather, and had not published the OEB after the occurrence, until the April of 2015. In fact, from 2005 till 2014, there had been total 54 uncommand autofeather events of ATR aircraft type caused by AFU, but ATR had not reminded the airlines to react or required additional training to such matters. Due to the flight crew had not received such Uncommand Autofeather ground and simulator training, the flight crew could not effectively identify the exact engine failure condition and follow the SOP. 2. The wiring anomaly of the engine system caused an engine failure which the flight crew had not received training for such false activation of ATPCS, ATR had not officially provide

	<p>generated a series of stall warnings, including activation of the stick shaker and pusher. After the engine number 1 was shut down, the loss of power from both engines was not detected and corrected by the crew in time to restart engine number 1. The crew did not respond to the stall warnings in a timely and effective manner. The aircraft stalled and continued descent during the attempted engine restart. The remaining altitude and time to impact were not enough to successfully restart the engine and recover the aircraft.</p>	<p>ATPCS process, the FDR recorded torque value of engine number 2 was even higher than the engine number 1 by about 10%. If analyzing such engine failure caused by the wiring anomaly, explaining what the flight crew could see and feel in the cockpit, it might increase the possibility to clarify the false perception of all three flight crew to misjudge the engine number 1 failed, thus CM1 continue the subsequent actions without being challenged or corrected by the other crew in a certain period. <del>Following the uncommanded autofeather of engine number 2 propellers, the flight crew did not perform the documented abnormal and emergency procedures to identify the failure and implement the required corrective actions. This led the pilot flying (PF) to retard power of the operative engine number 1 and shut down it ultimately. The loss of thrust during the initial climb and inappropriate flight control inputs by the PF generated a series of stall warnings, including activation of the stick shaker and pusher. After</del></p>	<p>information to deal with such emergency, resulting the flight crew could not have learned the possible restoration of engine number 2 power, and within the critical two seconds period of the activation of the ATPCS, the FDR recorded engine parameters were contrary to the ones displayed in a normal engine failure. If analyzing such engine failure caused by the wiring anomaly, explaining what the flight crew could see and feel in the cockpit, it might increase the possibility to clarify why CM1 mistakenly shut down the engine number 1, a possible key factor for the total power loss of the aircraft. Before conducting the procedures to restart the engine number 1, the aircraft continued to descent into the dense populated residential area, the flight director and the FMA displayed PITCH HOLD guidance, which was contrary to the stall recovery, causing the confusion indication and interferences to the flight crew. At the meantime, the flight crew showed great concerns about the terrain outside the cockpit, and was also</p>
--	---	--	---

		<p><del>the engine number 1 was shut down, the loss of power from both engines was not detected and corrected by the crew in time to restart engine number 2. The crew did not respond to the stall warnings in a timely and effective manner.</del></p> <p>The flight crew mistakenly step by step retard the engine number 1 throttle and shut it down at the end. The flight crew lost control of the both engines at the initial climb phase, which led to the activation of stall warning and stick shaker. After mistakenly shutting down the engine number 1, the aircraft lost the total available power. Also, the flight crew could not have known the possible power restoration of engine number 2. Considering the several related interference factors involved, it is quite impossible for the flight crew to react to the stall warnings rapidly and effectively.(NOTE 2). The aircraft stalled and continued descent during the attempted engine restart. The remaining altitude and time to impact were not enough to successfully restart the engine and recover the</p>	<p>changing the ATC communication channel, encountering consecutive activation of MASTER WARNINGS, the workload of flight crew was beyond normal human performance. The flight crew had not received training for, or being advised of such erroneous PITCH HOLD guidance. Once encounter such situation, the flight crew might not be able to handle it immediately. Let along being exhausted in handling the different MASTER WARNINGS and the power loss of both engines, the flight crew were not possibly properly handling the stall warnings.</p>
--	--	---	---

		aircraft.	
//3/1	Had the crew prioritized their actions to stabilize the aircraft flight path, correctly identify the propulsion system malfunction which was the engine number 2 loss of thrust and then take actions in accordance with procedure of engine number 2 flame out at take off, the occurrence could have been prevented.	<p>If the flight crew could have received the training regarding the torque and engine parameters information might occur during the uncommand autofeather process, the flight crew might possibly have a chance to correctly identify an engine failure, confirm the autofeather of number 2 engine, and conduct the SOP of uncommand autofeather, which might have prevent this occurrence. (NOTE 3)</p> <p><del>Had the crew prioritized their actions to stabilize the aircraft flight path, correctly identify the propulsion system malfunction which was the engine number 2 loss of thrust and then take actions in accordance with procedure of engine number 2 flame out at take off, the occurrence could have been prevented.</del></p>	<p>3. When encountered the uncommand autofeather, at the first moment the flight crew had to judge which engine has failed, the FDR recorded the engine parameters during activation of UPTRIM were opposite to the displayed parameters of an actual engine failure. The investigation report did not analyze such engine failure caused by the wiring anomaly, whether it induced opposite side load (lateral acceleration), causing a confusing visual and body sensational scenario, from the initial takeoff phase, and the subsequent FMA and MASTER WARNING messages, why the flight crew could not possibly identify the indications triggered by the ATPCS to learn which engine was actually failed. Only correct the activation of ATPCS caused by engine wiring anomaly, which could not be possibly simulated in the simulator training, the occurrence aircraft could then meet the initial airworthiness standard, thus prevent such occurrence.</p>

<p><b>Findings Related to Probable Causes /Flight Operations</b></p>	<p>3. The flight crew did not reject the take off when the automatic take off power control system ARM pushbutton did not light during the initial stages of the takeoffroll.</p> <p>4. TransAsia Airways did not have a clear documented company policy with associated instructions, procedures, and notices to crew for ATR72-600 operations communicating the requirement to reject the take off if the automatic take off power control system did not arm.</p> <p>5. Following the uncommanded autofeather of engine number 2, the flight crew failed to perform the documented failure identification procedure before executing any actions. That resulted in pilot flying's confusion regarding the identification and nature of the actual propulsion system malfunction and he reduced power on the operative engine number 1.</p> <p>6. The flight crew's non-compliance with TransAsia Airways ATR72-600 standard operating procedures -Abnormal and Emergency Procedures for an engine flame out at</p>	<p>3. The flight crew <del>did not reject the take off right away when the automatic take off power control system ARM pushbutton did not light during the initial stages of the takeoffroll</del>. <del>did not</del> abort the takeoff immediately, later on the ATPCS arm light lighted up again, consequently the flight crew continued the takeoff.</p> <p>4. <del>TransAsia Airways did not have a clear documented company policy with associated instructions, procedures, and notices to crew for ATR72-600 operations communicating the requirement to reject the take off if the automatic take off power control system did not arm. ATR had not established the associate procedures of ATR72-600 to require the flight crew to abort the takeoff when encountering the ATPCS not arm during the takeoff rolling phase.</del></p> <p>5. <del>Following the uncommanded autofeather of engine number 2, the flight crew failed to perform the documented failure identification procedure before executing any actions. That resulted in pilot flying's confusion</del></p>	<p>2. The wiring anomaly of the engine system caused an engine failure which the flight crew had not received training for such false activation of ATPCS, ATR had not officially provide information to deal with such emergency, resulting the flight crew could not have learned the possible restoration of engine number 2 power, and within the critical two seconds period of the activation of the ATPCS, the FDR recorded engine parameters were contrary to the ones displayed in a normal engine failure. If analyzing such engine failure caused by the wiring anomaly, explaining what the flight crew could see and feel in the cockpit, it might increase the possibility to clarify why CM1 mistakenly shut down the engine number 1, a possible key factor for the total power loss of the aircraft.</p> <p>Before conducting the procedures to restart the engine number 1, the aircraft continued to descent into the dense populated residential area, the flight director and the FMA displayed PITCH HOLD guidance, which was contrary to the stall</p>
--	---	---	---



	<p>take off resulted in the pilot flying reducing power on and then shutting down the wrong engine.</p> <p>7. The loss of engine power during the initial climb and inappropriate flight control inputs by the pilot flying generated a series of stall warnings, including activation of the stick pusher. The crew did not respond to the stall warnings in a timely and effective manner.</p> <p>8. The loss of power from both engines was not detected and corrected by the crew in time to restart an engine. The aircraft stalled during the attempted restart at an altitude from which the aircraft could not recover from loss of control.</p>	<p><del>regarding the identification and nature of the actual propulsion system malfunction and he reduced power on the operative engine number 1.</del></p> <p>Before the uncommand autofeather of engine number 2, although the flight crew identified the engine failure (CVR, FDR), the burst torque value of engine number 2 recorded by the FDR was higher than the engine number one. If analyzing such engine failure caused by the wiring anomaly, explaining what the flight crew could see and feel in the cockpit, it might increase the possibility to clarify the false perception of the flight crew to misjudge the operating engine number 1 as failed one, and CM1 continued to retard the engine number 1 throttle.</p> <p><del>6. The flight crew's non-compliance with TransAsia Airways ATR72-600 standard operating procedures - Abnormal and Emergency Procedures for an engine flame out at take off resulted in the pilot flying reducing power on and then shutting down the wrong engine. The FDR recorded engine number 2 torque</del></p>	<p>recovery, causing the confusion indication and interferences to the flight crew. At the meantime, the flight crew showed great concerns about the terrain outside the cockpit, and was also changing the ATC communication channel, encountering consecutive activation of MASTER WARNINGS, the workload of flight crew was beyond normal human performance. The flight crew had not received training for, or being advised of such erroneous PITCH HOLD guidance. Once encounter such, the flight crew might not be able to handle such event immediately. Let along being exhausted in handling the different MASTER WARNINGS and the power loss of both engines, the flight crew were not possibly properly handling the stall warnings.</p>
--	--	---	---

		<p>values caused by uncommand autofeather were contrary to the normal displayed engine failure parameters, ATR had not published the emergency procedure of the uncommand autofeather for the flight crew to follow. If analyzing such engine failure caused by the wiring anomaly, explaining what the flight crew could see and feel in the cockpit, it might increase the possibility to clarify what caused the flight crew to mistakenly retard the normal operating engine and shutting it down eventually.</p> <p><del>7. The loss of engine power during the initial climb and inappropriate flight control inputs by the pilot flying generated a series of stall warnings, including activation of the stick pusher. The crew did not respond to the stall warnings in a timely and effective manner. (Recommend to delete it. Please refer to note 2.)</del></p> <p><del>8. The loss of power from both engines was not detected and corrected by the crew in time to restart an engine. Due to the total power loss of both engines, it incurred tremendous workload for</del></p>	
--	--	--	--

		<p>flight crew and being busy in handling the different master warnings, thereby could not have been aware of the total power loss of both engines. The aircraft stalled during the attempted restart at an altitude from which the aircraft could not recover from loss of control.</p>	
<p><b>Findings Related to Risk /Powerplant</b></p>	<p>1. The engine manufacturer attempted to control intermittent continuity failures of the auto feather unit (AFU) by introducing a recommended inspection service bulletin at 12,000flight hours to address aging issues. The two AFU failures at 1,624flight hours and 1,206flight hours show that causes of intermittent continuity failures of the AFU were not only related to aging but also to other previously undiscovered issues and that the inspection service bulletin implemented by the engine manufacturer to address this issue before the occurrence was not sufficiently effective. The engine manufacturer has issued a modification addressing the specific finding of this investigation. This new modification is currently implemented in all new</p>	<p><del>1. The engine manufacturer attempted to control intermittent continuity failures of the auto feather unit (AFU) by introducing a recommended inspection service bulletin at 12,000flight hours to address aging issues. The two AFU failures at 1,624flight hours and 1,206flight hours show that causes of intermittent continuity failures of the AFU were not only related to aging but also to other previously undiscovered issues and that the inspection service bulletin implemented by the engine manufacturer to address this issue before the occurrence was not sufficiently effective. The engine manufacturer has issued a modification addressing the specific finding of this investigation. This new modification is currently implemented in all new</del></p>	<p>1. In addition to the AFU installed on the accident aircraft, another ATR72 also encountered a similar uncommand autofeather event on February 21, 2015. OEM shop test revealed both AFUs internal circuit board contact failure. Both defect AFUs were less than one year old, irrelevant to aging issues. 2. According to the PWC data, the AFU induced in-flight-shut-down (IFSD) events during November 2011 to May 2015 reached 25 cases. From 2011 to 2014, Uncommand Autofeather were 37 cases. PWC had completed the failure investigation in the cases and found the internal circuit board contact failure was the primary factor, also resulting from the poor manufacture quality. 3. During the investigation for the</p>

	<p>production engines, and another service bulletin is available for retrofit.</p>	<p><del>production engines, and another service bulletin is available for retrofit.</del> The causes of the continuously intermittent failures of the auto feather unit (AFU) were related to manufacture quality. The technical countermeasures implemented by the engine manufacturer to address the AFU continuity problems before the occurrence were ineffective. During investigation, engine manufacturer had completed the AFU failure investigation. Engine manufacturer had issued service bulletin (SB) requesting specific serial number AFUs to replace rigid-flex type J2 connector before specific date. But one airline had replaced with an AFU provided by the engine manufacturer which had completed the SB modification failed on its third flight. Engine manufacturer had started to redesign a new type AFU and expected to complete the design on 2017.</p>	<p>accident aircraft and above mentioned event on Feb. 21, 2015, CAA found that both AFU serial numbers are very close. CAA suspected the AFUs were manufactured in same batch. CAA requested the engine manufacturer to investigate the root cause and also should consider the production batch issue. PWC had completed the investigation and confirmed the internal circuit board contact failure was the root cause. PWC had issued SB ( PW100-72-21880 ) rev. 0 on 2015/10/19, requesting inspection of specific serial number AFU total 134 EA and to replace the rigid-flex type J2 connector before specific date. The SB kept on revision. In Rev. 1 the affected AFU number had increased to 156 EA. In Rev. 3 issued on February 4, 2016, it increased the affected AFU number to 492 EA. Every revision highlighted expanded AFU serial number and concurrently revealed the inherent production quality was not accurately fixed. This further concluded that batch production manufacture</p>
--	--	--	--

			<p>quality should be the issue.</p> <p>4. The briefing data provided by the PWC stated that the company had started to redesign the AFU and testing was in progress. PWC expects to issue the AFU improvement SB on 2017.</p>
<p><b>Findings Related to Risk / Flight Operations</b></p>	<p>2. Pilot flying's decision to disconnect the autopilot shortly after the first master warning increased the pilot flying's subsequent workload and reduced his capacity to assess and cope with the emergency situation.</p>	<p><del>2. Pilot flying's decision to disconnect the autopilot shortly after the first master warning increased the pilot flying's subsequent workload and reduced his capacity to assess and cope with the emergency situation.</del></p>	<p>Emulate the occurrence flight under the same condition in the simulator, the autopilot was disconnected by itself, not by the flight crew.</p>
<p><b>Findings Related to Risk / Airline Safety Management</b></p>	<p>6. While the TransAsia Airways (TNA) ATR72-600 differences training program was consistent with the European Aviation Safety Agency ATR72 operational evaluation board report and compliant from a Civil Aeronautics Administration regulatory perspective, it may not have been sufficient to ensure that TNA flight crews were competent to operate the ATR72-600 under all normal procedures and a set of abnormal conditions.</p> <p>7. The ATR72-600 differences training</p>	<p><del>6. While the TransAsia Airways (TNA) ATR72-600 differences training program was consistent with the European Aviation Safety Agency ATR72 operational evaluation board report and compliant from a Civil Aeronautics Administration regulatory perspective, it may not have been sufficient to ensure that TNA flight crews were competent to operate the ATR72-600 under all normal procedures and a set of abnormal conditions.</del></p> <p><del>7. The ATR72-600 differences training</del></p>	

	<p>records for the GE 235 flight crew showed that Captain A probably needed more training on the single engine flame out at take off procedure. That meant if the differences training records were stored, adequately maintained and evaluated by appropriate TransAsia Airways (TNA) flight operations and/or quality assurance personnel, the TNA would have had yet another opportunity to review Captain A's ability to handle engine out emergencies.</p> <p>8. Captain A's performance during the occurrence was consistent with his performance weaknesses noted during his training, including his continued difficulties in handling emergency and/or abnormal situations, including engine flame out at take off and single engine operations. However, TransAsia Airways did not effectively address the evident and imminent flight safety risk that Captain A presented.</p>	<p><del>records for the GE 235 flight crew showed that Captain A probably needed more training on the single engine flame out at take off procedure. That meant if the differences training records were stored, adequately maintained and evaluated by appropriate TransAsia Airways (TNA) flight operations and/or quality assurance personnel, the TNA would have had yet another opportunity to review Captain A's ability to handle engine out emergencies.</del></p> <p>8. Captain A's performance during the occurrence was consistent with his performance weaknesses noted during his <b>ATR72-500 to ATR72-600 differences</b> training, <del>including his continued difficulties in handling emergency and/or abnormal situations, including</del> <b>indicating the requirement of remedial training of</b> engine flame out at <b>takeoff</b> and single engine operations. However, TransAsia Airways did not effectively address the evident and imminent flight safety risk that Captain A presented.</p>	
--	--	--	--

<b>Findings Related to Risk / Regulatory Oversight</b>	<p>10. The systemic TransAsia Airways (TNA) flight crew non-compliances with standard operating procedures identified in previous investigations, including GE 222, remained unaddressed at the time of the GE235 occurrence. Although the Civil Aeronautics Administration (CAA) had conducted a special audit after the GE 222 accident which identified the standard operating procedures compliance issue, the CAA did not ensure that TNA responded to previously identified systemic safety issues in a timely manner to minimize the potential risk.</p>	<p><del>10. The systemic TransAsia Airways (TNA) flight crew non-compliances with standard operating procedures identified in previous investigations, including GE 222, remained unaddressed at the time of the GE235 occurrence.</del> Although the Civil Aeronautics Administration (CAA) had conducted a special audit after the GE 222 accident which identified the standard operating procedures compliance issue, the CAA <del>did not</del> <b>improved the</b> <del>ensured that</del> <b>TNA responded to</b> previously identified systemic safety issues in a timely manner to minimize the potential risk.</p>	<p>The ASC didn't suggest any issue regarding TNA before the GE222 investigation final report published on 29<sup>th</sup> JAN, 2016.</p>
<b>Safety Recommendations /To Civil Aeronautics Administration</b>	<p>1. Review airline safety oversight measures to ensure that safety deficiencies are identified and addressed in an effective and timely manner. 2. Implement a highly robust regulatory oversight process to ensure that airline safety improvements, in response to investigations, audits, or inspections, are implemented in a timely and effective manner.</p>	<p><del>1. Review airline safety oversight measures to ensure that safety deficiencies are identified and addressed in an effective and timely manner.</del> <del>2. Implement a highly robust regulatory oversight process to ensure that airline safety improvements, in response to investigations, audits, or inspections, are implemented in a timely and effective manner.</del></p>	<p>Incorporated with the third point.  The ASC didn't suggest any related issue before the GE222 investigation final report published on 29<sup>th</sup> JAN, 2016.</p>

	<p>3. Conduct a detailed review of the regulatory oversight of TransAsia Airways to identify and ensure that the known operational safety deficiencies, including crew noncompliance with procedures, nonstandard training practices, and unsatisfactory safety management, were addressed effectively.</p>	<p>3. Conduct a detailed review of the regulatory oversight of TransAsia Airways to identify and ensure that the known operational safety deficiencies, including crew noncompliance with procedures, nonstandard training practices, and <del>unsatisfactory</del> safety management <b>function</b>, were addressed effectively.</p>	
--	---	--	--



## Appendix 15-5 Comments on ASC's Draft Final Report from TransAsia Airways



復興航空  
**TransAsia**

# GE235 事件 復興航空陳述意見

報告人  
復興航空



- *原條文3.1.4 TransAsia did not have a clear documented company policy with associated instructions, procedures, and notices to crew for ATR72-600 operations communicating the requirement to reject the take off if the automatic take off power control system did not arm.*

- **Recommendation** : Delete

- **Reason:**

TransAsia does have a policy in our FOM to guide the pilot to handle the system malfunction after engine started and before take off. See FOM attachment.

### 13.2.2 作業程序

#### 故障發生時：

當飛機系統/組件發生故障或缺少某些次要機體零件且無法立即完成修護時，得依 MEL/CDL 的規定轉入延遲改正缺點(DD)項目延後予以修護，同時機長必須與機械員共同討論，最後由機長決定是否起飛。若遭遇操作限制、乘客處理或貨運處置之延遲改正缺點(DD)項目，MCC 應即時通知聯合管制中心，並附上電腦列印之最新 DD 管制表乙份，作為聯合管制中心飛機派遣、調度及飛航組員報到時簡報之參考依據。

機務人員必須將前述故障轉入延遲改正缺點 (DD)項目，並在機上的 DD 現況表 (TLB 夾檔中的黃卡) 中加入該故障項目，如該項目有 (o) 或 (m) 程序，則必須勾選 DD 現況表的 REMARKS / EXCEPTIONS 欄位上的相關選項，以提醒駕駛員及機械員。

簽派員必須檢視該項故障是否有影響飛航、乘客處理及貨運處理等限制，進而修改其飛航計畫或通知運務相關單位。

#### 注意：如果在後推至起飛前發現裝備故障：

- 若 MEL 程序要求該項目應由機務人員執行維護程序(有(m)符號)，則必須滑回，不得起飛。
- 若依 MEL 規定，認定航機仍可運作，且無需機務人員執行修復者，則可以繼續起飛。但若該項目有 (o) 符號，則飛航組員必須完成相關程序，並在可行的情況下通知聯管中心或可聯繫到的地面單位後再繼續起飛。
- 若該故障未列於 MEL 中，則必須滑回，不得起飛。

- *原條文 3.1.5 Following the uncommanded autofeather of engine number 2, the flight crew failed to perform the documented failure identification procedure before executing any actions. That resulted in pilot flying's confusion regarding the identification and nature of the actual propulsion system malfunction and he reduced power on the operative engine number 1.*
- **Recommendation : Modify as below**
- 3.1.5 Following the uncommanded autofeather of engine number 2, the flight crew failed to perform the documented failure identification procedure before executing any actions. **Due to over torque amber indication, pilot flying reduced power on the operative engine number 1 and resulted in pilot flying's confusion regarding the identification and nature of the actual propulsion system malfunction**

Reason:

According to ATR FCOM 1.16.40 and TNA simulator test, the TQ indication will change from green color to amber color. ([show video](#))

	POWER PLANT		1.16.40	
	CONTROLS		P 8	001
			APR 11	

(1) TORQUE INDICATOR

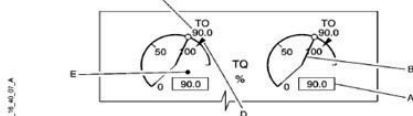

Two sensing torque probes are located on the reduction gear box. One of them sends a signal to the AFU which controls the torque analogic pointer (B). The other one sends a signal to the EEC which controls the torque digital counter (A).

(A) Digital counter

Actual digital torque indication is displayed. Torque readout is :

- green surrounded by a grey rectangle if TQ is in green sector
- amber surrounded by an amber rectangle if TQ is in amber sector
- white in red reversed video if TQ is above amber sector limit
- amber "LAB" label surrounded by an amber rectangle if a wrong EEC is installed
- green, amber, white or red reverse video surrounded "----" if EEC cannot control the HBV
- amber "HBV" label surrounded by an amber rectangle in case of invalid torque value.

(B) Pointer

Gives the indication of actual analogic torque. Pointer is :

- green in Green sector (0 - 100%)
- amber in Amber sector (100 - 106%)
- red if torque is higher than 106%
- The pointer is stopped if TQ>120%

At 10:52:35, ATPCS activated.  
 At 10:52:37, Engine 1 TQ indicated 100.9, the indication changed from normal green color to caution amber color.  
 At 10:52:38, Engine 1 TQ indicated 104.1, one second later, the pilot start to retard engine power lever to prevent engine 1 operated under caution condition.

原條文3.1.6 The loss of engine power during the initial climb and inappropriate flight control inputs by the pilot flying generated a series of stall warnings, including activation of the stick pusher. The crew did not respond to the stall warnings in a timely and effective manner.

Recommendation : Modify as below

3.1.6 The loss of engine power during the initial climb and following Flight Director guidance generated a series of stall warnings, including activation of the stick pusher. ~~The crew did not respond to the stall warnings in a timely and effective manner.~~

- Reason :

1. According FDR and TNA simulator test flight, the pitch bar of the Flight Director went upward instead of downward to maintain selected IAS when pilot reduced No. 1 engine power. (Show video)
2. 原條文中**The crew did not respond to the stall warnings in a timely and effective manner.** This conclusion is not analyzed in the report.

- 原條文3.2.2 *Pilot flying's decision to disconnect the autopilot shortly after the first master warning increased the pilot flying's subsequent workload and reduced his capacity to assess and cope with the emergency situation.*
- Recommendation : Modify as below
- 3.2.2 Autopilot **disengagement** shortly after the first master warning increased the pilot flying's subsequent workload and reduced his capacity to assess and cope with the emergency situation.

- Reason :

The FDR did not record the following Automatic Disengagement parameters:

1. AP inner loops inputs
2. AP inner loops commands
3. AP actuators
4. Power on Safety Tests detecting Fault

And also cannot determine which pilot disconnected the autopilot.

- Recommendation : 新增

- 4.1 To UTAS

To figure out and find the root cause of the **J2 connector defects on production line**, which might involved material quality issue, procedure appropriateness issue, and process compliance issue, if the problem cannot be point out certainly, the fail rate will still stay high and come with more maintenance burdens and fatal risks in flight.

- Reason :

1. The investigation result indicated J2 connector discontinuity situation led the 235 events initially, and it DOES NOT only occur in the TNA fleet, this result could prove the **previous several service bulletins is futile** To BEING AFU reliability improvement, The J2 wiring issue has existed for many years.
2. In reference to SB21880, it has different categories and some specific AFUs serial numbers that may have been affected with production line issues are required to be returned by specific dates, and this SB has been revised to no. 5 version.

 TransAsia 復興航空

3. P&WC expects the 2017 improved design AFU will solve the known problems.
4. All above are “solutions” that popped up to discuss onto improving or making sure the function of AFU triggers ATPCS properly, but does not address what these production line errors are and **how these errors were occurred?**

 TransAsia 復興航空

5. Manufacturer is going to issued one more service bulletin after SB21880, due to several AFU failure already reported on new modified AFUs, this coming SB to be issued aims to improving the reliability of post SB21880 AFUs.
6. Neither the redesign of the physical configuration or schematic/wiring concept nor how many modifications manufacturer is going to issue, to find out the real problems on the production line and improve/ensure **the quality of the products is the most important** and most valuable improvement and goal.

Unit 機組單位	Time/時間	History/歷史	Issuance 文件編號	Description/描述	Year /年度	Uncommand Autofeather	非正常 自動復原事件
PFC	August 15, 2007	AFU One time Inspection / Electrical connectors	SB 21742	AFU快速維修執行一次巡迴檢驗計畫	2007-2007		24 次
ATR	June 1, 2010	Wiring/Connector Issue	MOD 6459	發動機電線捆綁有不良捆綁現象通告	2008-2010		20 次
PFC	December 14, 2010	EG converter crack inspection / CIM TR73-01	SIL PF100-138	EG 繞線發現螺絲鬆動問題			
TUA	August 16, 2011	B-22812 No.1 ENG ESN EB0069 Uncommand Autofeather			2011		19 次
PFC	September 28, 2011	EG converter inspection J1 J2 / SIL PF100-138 / TSM 77-13-00 information	SIL PF100-147	發現287DC交流電平穩器AFU運作			
PFC	October 20, 2012	Low Pass Filters	PVC SB 21822	AFU快速維修執行問題修改，改善無預警的失效熱保護造成自動復原問題	2012		14 次
PFC	May 12, 2014	J2 connector insufficient solder	PVC SB 21859R0	J2 螺絲螺絲不足問題	2013-2014		23 次
PFC	July 18, 2014	J2 connector insufficient solder	PVC SB 21859R1	修改螺絲膠膠後			
TUA	February 4, 2015	B22816 No.2 ENG ESN E20013 Uncommand Autofeather					
TUA	February 21, 2015	B22808 No.1 ENG ESN E20021 Uncommand Autofeather					
PFC	April 20, 2015	J2 connector insufficient solder	PVC SB 21859R2	修改螺絲膠膠後			
PFC	July 14, 2015	J2 connector / SB21880 information	PVC SIL PF100-170R0		2015		16 次
PFC	October 16, 2015	Rigid-flex type J2 connector	SB 21880R0				
PFC	October 20, 2015	Rigid-flex type J2 connector	SB 21880R1				
PFC	November 3, 2015	J2 connector / SB21880 information	PVC SIL PF100-170R2				
PFC	January 11, 2016	Rigid-flex type J2 connector	SB 21880R2				
PFC	February 4, 2016	Rigid-flex type J2 connector	SB 21880R3	AFU重新製造後仍發生SB目的，改善其他AFU 內部安裝螺絲 J2 connector 問題並修正有無法解決或無法即時維修事件修改，其螺絲系統也增加螺絲保護螺絲執行修改。			
PFC	January 11, 2016	J2 connector / SB21880 information	PVC SIL PF100-170R3		2016		13X
ATR	June 17, 2016	Rigid-flex type J2 connector	ADM 42/72/2015/010 Issue3				
PFC	May 19, 2016	rigid-flex type J2 connector	SB 21880R4				
PFC	May 20, 2016	J2 connector / SB21880 information	PVC SIL PF100-170R4				

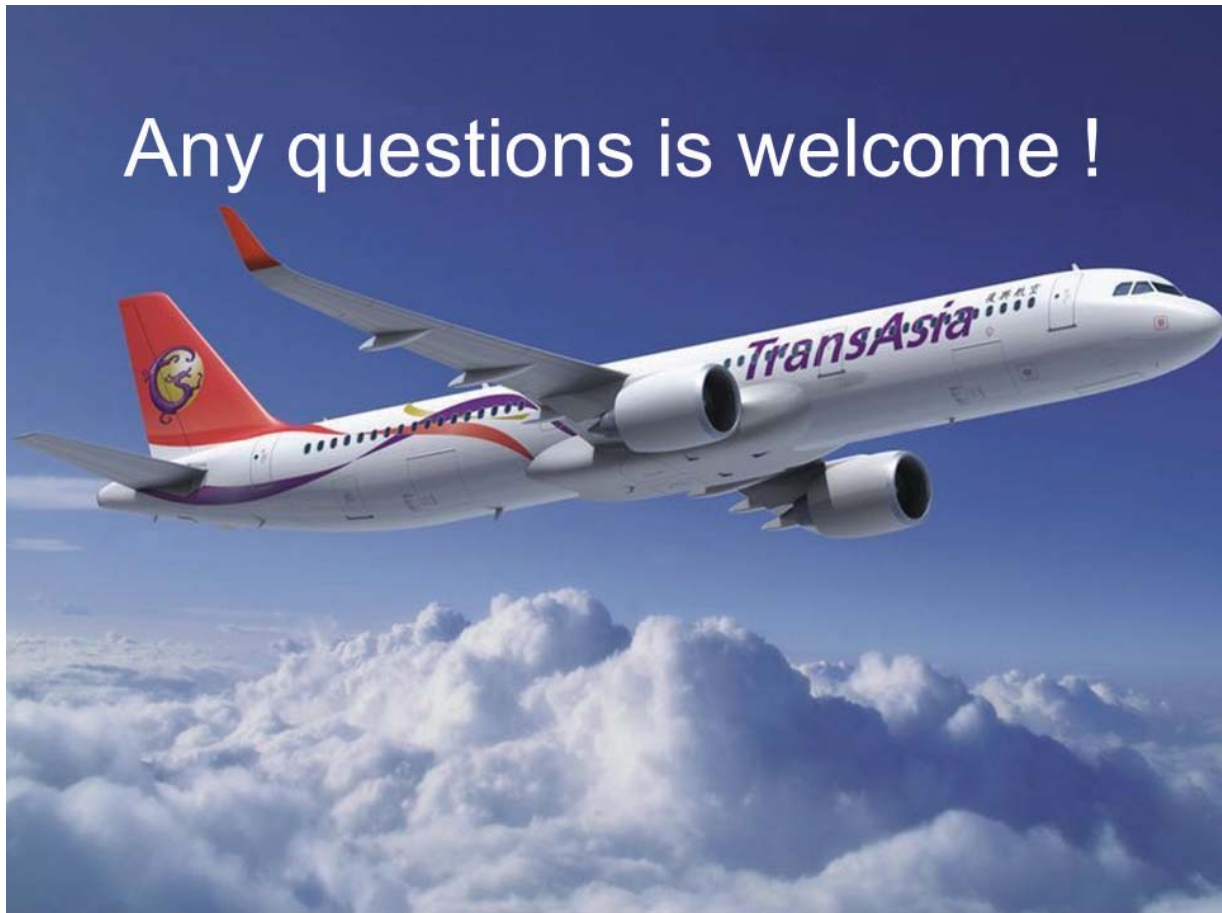





**AVIATION SAFETY COUNCIL**

11<sup>th</sup> Floor, 200, Section 3, Beixin Road, Xindian District,  
231 New Taipei City, Taiwan (R.O.C.)

TEL : (02)89127388

FAX : (02)89127399

URL : <http://www.asc.gov.tw>

ISBN 978-986-04-9717-5



GPN:4910501705